



hatho

rotierende Polierwerkzeuge
rotating polishing instruments

outils rotatifs de polissage

herramientas rotativas de pulido
spazzole per lucidare

2016
2017
2018
2019



INHALT

CONTENTS INDEX

ÍNDICE INDICE

Seite
Page

1		HoPla - Bürsten, Rundbürsten mit Holzkern	8
		HoPla - Lathe Brushes with plastic and wooden core	
		HoPla - Brosses circulaires avec centre en plastique et bois	
		HoPla - Cepillos para el pulido con centro de plástico y madera	
		HoPla - Spazzole HoPla con centro in plastica e legno	
		Einlagebürsten	16
		Poly - Buffs	
		Brosses avec disques intercalés	
		Cepillos con entretelas	17
		Spazzole con strati intermedi	
2		Schmalbürsten	18
		Slimline Brushes	
		Brosses au centre métallique	
		Cepillos de forma estrecha	
		Spazzole con centro metallico	21
3		Polierschwabbeln	22
		Polishing Discs	
		Disques de polissage	
		Discos de pulido	
		Dischi per lucidare	29
4		HABRAS Bürsten, HABRAS Discs	30
		HABRAS Brushes, HABRAS Discs	
		Brosses HABRAS, HABRAS Discs	
		Cepillos HABRAS, HABRAS Discs	
		HABRAS Spazzole, HABRAS Discs	
5		Miniaturbürsten	36
		Miniature Brushes	
		Brossettes Miniatures	
		Cepillos Miniaturas	
		Spazzole Miniatur	
6		Miniaturschwabbeln	44
		Miniature Polishing Discs	
		Disques miniatures à polir	
		Discos miniaturas de pulimento	
		Dischi miniatur per lucidare	

7		<p>Filzpolierkörper Felt polishers Feutres Filtros para pulir Feltri per lucidare</p>	<p>46 47</p>
8		<p>HATHOfex S plus P HATHOfex S plus P</p>	<p>48 49</p>
9		<p>Minibestbürsten Minibest Brushes Brosses Minibest Cepillos Minibest Spazzole Minibest</p>	<p>50 51</p>
10		<p>Miniatürkelle, Miniaturpinsel (Endbürsten) Miniature Brushes cup shaped, End Brushes Brosses miniatures en forme de coupe, Mini pinceaux Cepillos miniaturas en forma de copa, pinceles Spazzole miniatura coppetta, pennelli</p>	<p>52 57</p>
11		<p>Picobürsten, Microbürsten Pico Brushes, Micro Brushes Brossettes Pico, Brossettes Micro Cepillos Pico, Cepillos Micro Spazzole Pico, Spazzole Micro</p>	<p>58 61</p>
12		<p>Diamantierte Bürsten und Polierer, DiaDisc, DiaStone Diamond Brushes and Polishers, DiaDisc, DiaStone Brosses et polissoirs diamantés, DiaDisc, DiaStone Cepillos y pulidores diamantados, DiaDisc, DiaStone Spazzole diamantate e lucidanti, DiaDisc, DiaStone</p>	<p>62 63</p>
13		<p>Polistar Polierpasten, Mandrels, Werkzeugständer Polistar Polishing Compounds, Mandrels, Instrument Holder Pâtes à polir Polistar, Mandrins, présentoir vide Pastas de pulido Polistar, Mandriles, expositores Paste per lucidare Polistar, Mandrini, Portastrumenti</p>	<p>64 67</p>
14		<p>FiberDisc, Naturhaarpinsel, Spindeladapter, Mattschlagbürsten FiberDisc, Natural Hair Brush, Bur Chucks, Matting Brushes FiberDisc, Pinceau en soies naturelles, Porte-brossette, Brosses à mater FiberDisc, Cepillos de pelos naturales, Porta cepillos, Cepillos para matar FiberDisc, Pennelli in setole naturali, Adattatori di mandrini, Spazzole per satinare</p>	<p>68 71</p>

The HATHO Team • L'équipe HATHO • El equipo HATHO • Il Team HATHO

möchte Ihnen mit diesem Katalog unser umfangreiches Sortiment an rotierenden Polierwerkzeugen vorstellen.
Alle unsere Produkte werden von uns in Eschbach im schönen Markgräflerland hergestellt.
Wir freuen uns, wenn Sie bei uns das von Ihnen gesuchte Produkt finden können.

would like to present to you with this catalog the large product range of rotating polishing instruments .
All our products are produced in Eschbach, a town located in one of the loveliest areas of Germany called Markgräflerland.
We hope you will find the product you are looking for in this comprehensive catalog.

vous présente avec ce catalogue une très large gamme d'article d'outils de polissage rotatif.
Tous nos produits sont fabriqués à Eschbach, une ville située dans la belle région de Markgräflerland.
Nous serions très heureux si vous aller trouver les articles demandés.

Nos complace presentarles con este catálogo nuestra amplia gama de herramientas rotativas.
Todos los productos están fabricados por nuestra compañía en Eschbach, ciudad situada en la maravillosa región alemana de Markgräflerland. Esperamos que pueden encontrar el producto que están buscando en nuestro catálogo.

Con questo nuovo catalogo il Team Hatho vi vuole presentare l'ampio assortimento dei suoi prodotti, che vengono fabbricati nel nostro stabilimento di Eschbach nella piacevole regione tedesca del Markgräflerland.
Saremmo lieti di sapere se, tra i nostri prodotti, avete trovato quanto cercavate.



Maren Holzmann
Produktmanagerin
Product Manager
Chef de produits
Jefe de productos
Dirigente dei prodotti



Paul Degrande
Senior Produktmanager
Senior Product Manager
Senior chef de produits
Senior Jefe de Productos
Senior dirigente dei prodotti



Dr. Ralf Steiner
Geschäftsführer
Managing Director
Directeur
Director gerente
Direttore dell'azienda



Anna von Sponeck
Assistentin der Geschäftsleitung
Assistant to the Managing Director
Assistante de direction
Assistente della direzione
Ayudante de dirección



Astrit Thomann
Verkaufsleiterin
Head of Sales
Chef de ventes
Jefe de ventas
Direttrice delle vendite



Christina Schütz
Vertriebsleiterin
Head of Distribution
Chef de la distribution
Jefe de la distribución
Direttrice della distribuzione



Bernhard Brugger
Produktionsleiter,
Qualitätsbeauftragter
Head of Production,
Quality Manager
Directeur technique,
responsable de la qualité
Director técnico,
responsable de la calidad
Direttore di produzione,
responsabile della qualità



Rolf-Dieter Ulitzka
stellv. Produktionsleiter
Deputy Head of Production
Directeur de production adjoint
Director adjunto de producción
Direttore di produzione vicario



Lucia Fucci
Leiterin Versandabteilung
Head of shipping department
Chef service des expéditions
Jefe de departamento de envíos
Direttrice della spedizione



Barbara Raach
Buchhaltung
Accounts Department
Comptabilité
Contabilidad
Contabilità



Nicoletta Caruso
Disposition
Planning
Disposition
Disposizione
Responsabile del magazzino

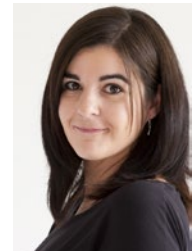

Nadine Wehrle
Leiterin Verpackungsabteilung
Head of packaging department
Chef département emballage
Jefe departamento embalaje
Direttrice del reparto di imballaggio



Janine Haase
Auftragsabwicklung
Order Processing
Gestion des commandes
Gestión de los pedidos
Disbrigo degli ordini



Perfektion für Oberflächen

Perfection for Surfaces

Perfection des surfaces

Perfección para las superficies

La perfezione per le superfici



Verbesserung des Bestehenden und Entwicklung von Neuem: so lauten die Prämissen von HATHO.

Sie betreffen sämtliche Produktionsmittel und - abläufe und vor allem jedes einzelne Produkt. Ein lebendiger Kreislauf der Optimierungen und Innovationen, der nicht zum Stillstand kommt. Die logische Konsequenz des hohen Anspruchs sind eine Vielzahl neuer Anwendungen und Produkte, nationale und internationale Patente sowie ein Qualitätsmanagement gemäß ISO 9001:2008.

The improvement of what is and the development of what will be – these are HATHO's priorities.

They apply to every production material and, above all, to every single product. A dynamic and never ending cycle of optimisation and innovation is created. The logical result of such high standards is a wide range of new applications and products, national and international patents and a certified quality management according to ISO 9001:2008.

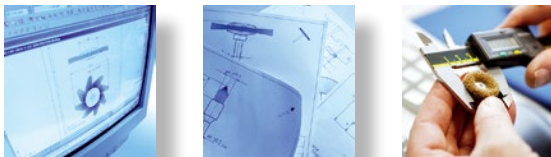

L'amélioration de l'existant et le développement de nouveautés sont les prémisses de la maison HATHO: les moyens et les processus de productions bénéficient à tous les produits.

C'est un cycle d'optimisations et d'innovations qui ne s'arrête jamais. La conséquence logique est un grand nombre de nouveaux produits et applications, ainsi que de brevets nationaux et internationaux et la gestion de la qualité des produits, certifiée ISO 9001 :2008.

Perfeccionamiento de lo existente y desarrollo de lo nuevo: esas son las premisas de HATHO. Se aplican a todos los medios y procesos de producción, en particular, a cada producto.

Un ciclo dinámico de optimización e innovación, que nunca se termina. La consecuencia lógica de tales exigencias muy elevadas es una multiplicidad de nuevas aplicaciones y productos, patentes nacionales e internacionales. La gestión de calidad está certificada según ISO 9001:2008.

Migliorare il prodotto esistente e sviluppare le novità: queste sono le premesse della HATHO, che riguardano mezzi ed i processi di produzione di ogni singolo articolo.

Un ciclo continuo e dinamico di miglioramenti ed innovazioni. Il risultato logico di standard così alti é un ampio raggio di nuove applicazioni e di nuovi prodotti, brevetti nazionali ed internazionali e certificazioni quali l'ISO 9001:2008.

HATHO HoPla

Eine Holzbuchse im Zentrum des Kunststoffkerns
 Wooden center encased in plastic core
 Noyau plastique avec un centre en bois
 Un casquillo de madera en el centro plástico
 Un nocciolo in legno nel centro del mozzo di plastica



HATHO Pico Bürsten

Polierbürsten mit zehn Millimeter Durchmesser für filigrane Zwischenräume
 Polishing brushes Ø 10 mm for small interdental areas
 Brochettes à polir Ø 10 mm pour des espaces filigrane
 Cepillos con un diametro de 10 mm para el pulido de intersticios filigranes
 Spazzole per lucidare con un diametro di 10 mm per spezi piccolissimi



HATHO Brechflansch Removable ring system Anneaux détachables Anillos desmontables Anelli smontabili

Abbrechbares Ringsystem zur seitlichen Stabilisierung der Schwabbeln
 Removable ring system, provides lateral stability to polishing discs
 Disques à anneaux détachables donnent une stabilité maximale
 Anillos desmontables para la estabilización lateral del disco de pulido
 Sistema di rottura degli anelli, che garantisce una stabilità laterale della spazzola



HATHO UniFix

Kunststoffkern mit abgestuftem Zentrum zur besseren Fixierung und Zentrierung der Polierschwabbeln
 Plastic core with stepped arbour hole for better fixing and centering on the spindle
 Noyau en plastique avec un centre gradué pour fixation et centrage optimal des disques à polir
 Núcleo de plástico con centro escalonado para mejor fijación y centrado de disco de pulido
 Mozzo in plastica con centro graduato per facilitare il fissaggio e il centraggio della spazzola

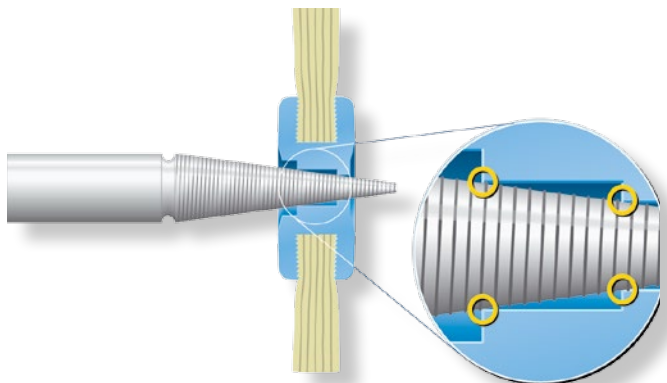

HATHO FILIO®

Adapter zur Montage von Schaftbürsten auf Poliermotor
 Adapter for mounting shank brushes on conical spindles of a polishing unit
 Adapteur pour monter les brosses miniatures sur tige au moteur à polir
 Un adaptador para el montaje de los cepillos de vástago en las máquinas de pulimento
 Adattatore per il montaggio di spazzole con gambo

Umrechnungstabelle Inch/mm
Conversion chart Inch/mm
Tableau comparatif Inch/mm
Indicator comparativo Inch/mm
Tabella di conversione Inch/mm

	0.003"	0,076 mm
	0.004"	0,102 mm
	0.005"	0,127 mm
	0.006"	0,152 mm
3/32"	0.094"	2,381 mm
1/8"	0.125"	3,175 mm
3/16"	0.188"	4,762 mm
1/4"	0.250"	6,350 mm
9/32"	0.281"	7,144 mm
3/8"	0.375"	9,525 mm
1/2"	0.500"	12,70 mm
9/16"	0.563"	14,29 mm
11/16"	0.688"	17,46 mm
3/4"	0.75"	19,05 mm
1"	1.0"	25,40 mm
2"	2.0"	50,80 mm
3"	3.0"	76,20 mm
4"	4.0"	102 mm
5"	5.0"	127 mm
6"	6.0"	152 mm

Schaftdurchmesser Inch/mm
Shank diameter Inch/mm
Diamètre de la tige Inch/mm
Diámetro del vástago Inch/mm
Diametro del gambo Inch/mm

HP	3/32"	2,34 mm
HP.B		3 mm
HP.C	1/8"	3,17 mm
HP.6		6 mm

Bohrungsdurchmesser
unmontierter Bürsten Inch/mm
Arbor hole diameter of unmounted
brushes Inch/mm
Diamètre d'alésage d'une brosse
non montée
El diámetro de vástago de los
cepillos non montado
Diametro del foro centrale delle
spazzole non montate

RED		1,8 mm
UM		2,5 mm
UMC	1/8"	3,17 mm

Verpackungseinheit
Packing unit
Nombre de pièces par emballage
Número de piezas per embalaje
Unità di imballaggio



Beispiele
 examples
 exemples
 ejemplos
 esempi





HoPla - Bürsten, Rundbürsten mit Holzkern
HoPla - Lathe Brushes with plastic and wooden core
HoPla - Brosses circulaires avec centre en plastique et bois
HoPla - Cepillos para el pulido con centro de plástico y madera
HoPla - Spazzole HoPla con centro in plastica e legno

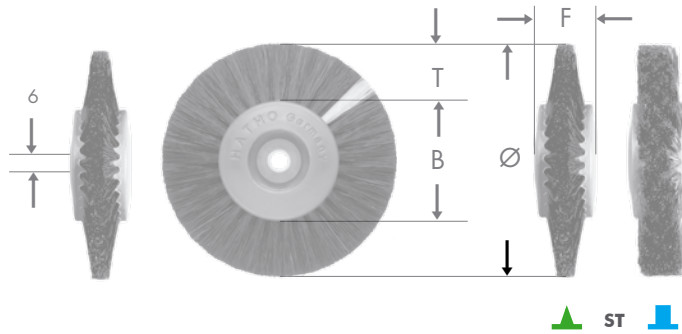

Besatzmaterial schwarze oder weiße Chungking Borsten
filling material black or white Chungking bristles
matériel de garniture soie de Tchong King noire ou blanche
guarnición cerda de Chung King negra o blanca
materiale utilizzato setola die Chungking nera o bianca

ZR = Zahl der Reihen
 numbers of rows
 nombres de rangs
 número de hileras
 numero dei ranghi

1:2

↻ 2.800

























Art.Nr. art.No.	ZR	Ø mm	B mm	T mm	ST
1135	1	35	25	5	-
1144	1	44	25	9,5	-
0144	1	44	25	9,5	-
1145	1	45	25	9,5	-
H 104	1	48	22	13	-
1150 H	1	50	26	12	-
1160 H	1	60	32	14	-











1:2

↻ 2.800











	Art.Nr. art.No.	ZR	Ø mm	B mm	T mm	ST
	1165 H	1	65	40	12,5	-
	SE 1C	1	67	48	9,5	-
	1245	2	45	25	9,5	▲
	1250	2	50	25	12,5	▲
	1250 H	2	50	25	12,5	▲
	0250	2	50	25	8,5	▲
	0250 H	2	50	25	8,5	▲
	SE 6C	2	51	32	9,5	▲
	H 114	2	54	25	14,5	▲
	1255	2	55	33	11	▲
	1255 H	2	55	33	11	▲
	0255	2	55	33	11	▲
	0255 H	2	55	33	11	▲

	Art.Nr. art.No.	ZR	Ø mm	B mm	T mm	ST
	1260	2	60	40	10	▲
	1260 H	2	60	35	12,5	▲
						
	H 120	2	64	32	16	▲
						
	1265	2	65	45	10	▲
	1265 H	2	65	40	12,5	▲
	SE 2C	2	67	48	9,5	▲
	1270	2	70	50	10	▲
	1270 H	2	70	50	10	▲
						
	SE 2B	2	73	48	12,5	▲
						
	1280 H	2	80	40	20	▲
						

	Art.Nr. art.No.	ZR	Ø mm	B mm	T mm	ST
	1355	3	55	28	13,5	▲
	1355 H	3	55	28	13,5	▲
	0355	3	55	28	13,5	▲
	H 124	3	58	32	13	▲
	1360 H	3	60	35	12,5	▲
	1370	3	70	40	15	▲
	1370 H	3	70	40	15	▲
	0370	3	70	40	15	▲
	H 123	3	70	32	19	▲
	1380 H	3	80	40	20	▲

	Art.Nr. art.No.	ZR	Ø mm	B mm	T mm	ST
	137	3	70	40	15	
	137 H	3	70	40	15	
	037	3	70	40	15	
	138	3	80	40	20	
	138 H	3	80	40	20	
	1399 H	3	100	60	20	
	1460	4	60	40	10	
	1460 H	4	60	35	12,5	
	1465 H	4	65	35	15	
	1470 H	4	70	40	15	

	Art.Nr. art.No.	ZR	Ø mm	B mm	T mm	ST
	1475 H	4	75	40	17,5	▲
	1480	4	80	40	20	▲
	1480 H	4	80	40	20	▲
	0480	4	80	40	20	▲
	1480 EH	4	80	40	20	▲
	1480 H/EH	4	80	40	20	▲
	extra hart extra hard extra dur extra dura extra dura					
	4R 80 121	4	80	40	20	▲
	super hart super hard super dur super dura super dura					
	4R 80 120	4	80	40	20	▲
	super hart super hard super dur super dura super dura					

		Art.Nr. art.No.	ZR	Ø mm	B mm	T mm	ST
		146 EH	4	60	40	10	↓
		146 H/EH	4	65	35	15	↓
		147 H	4	70	40	15	↓
		H 129	4	76	38	19	↓
		148	4	80	40	20	↓
		148 H	4	80	40	20	↓
		148 H/EH	4	80	40	20	↓
		extra hart extra hard extra dur extra dura extra dura					
		1499 H	4	100	60	20	▲

	Art.Nr. art.No.	ZR	Ø mm	B mm	T mm	ST
	156 H	5	60	40	10	
	1599 H	5	100	60	20	
	1699 H	6	100	60	20	
	weißes Ziegenhaar white goat hair poils de chèvre blancs pelo de cabra blanco pelo di capra bianco	4	80	40	20	
	Tampico fiber Tampico fibre Tampico fibre Tampico fibre Tampico fibra	4	90	50	20	
	550/4s/50/90 H	4	90	50	20	
	121 35 Palatinal		35	14		



Einlagebürsten
Poly - Buffs
Brosses avec disques intercalés
Cepillos con entretelas
Spazzole con strati intermedi

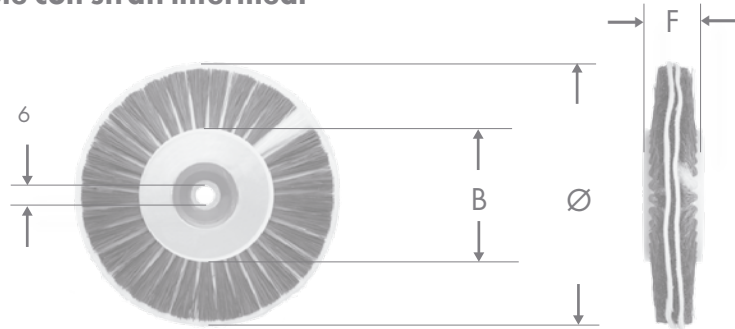







↻ 2.800



	Art.Nr. art.No.	Ø mm	B mm	F mm
<p>schwarze Chungking Borsten, Nesselstoffscheiben black Chungking bristles, muslin discs soie de Tchong King noire, disques en mousseline cerda de Chung King negra, entretelas de muselina setola di Chungking nera, strati di mussola</p>	5250	50	25	13
	5365	65	35	17
	5380	80	40	18
	5480	80	40	24
<p>schwarze Chungking Borsten, Filztuchscheiben black Chungking bristles, felt cloth discs soie de Tchong King noire, toile de feutre cerda de Chung King negra, paño de fieltro setola di Chungking nera, strati di feltro</p>	6380	80	40	18
	6480	80	40	24
<p>schwarze Chungking Borsten, Lederscheiben black Chungking bristles, leather discs soie de Tchong King noire, disques peau de chamois cerda de Chung King negra, entretelas de cuero setola di Chungking nera, strati di pelle</p>	7380	80	40	18
	7480	80	40	23

2.800



	Art.Nr. art.No.	Ø mm	B mm	F mm
<p>weiße Chungking Borsten, Scotch Brite™ white Chungking bristles, Scotch Brite™ soie de Tchong King blanche, disques de Scotch Brite™ cerda de Chung King blanca, entretelas de Scotch Brite™ setola di Chungking bianca, strati di Scotch Brite™</p> 	4280	80	40	15
<p>schwarze Chungking Borsten, silikoniertes Baumwollgewebe black Chungking bristles, silicon coated cotton fabric soie de Tchong King noire, tissu de coton siliconé cerda de Chung King negra, tejido de algodón siliconado setola di Chungking nera, tessuto di cotone siliconato</p> 	8277	77	40	18
<p>weiße Chungking Borsten, ZETA Tuch, weißes Scotch Brite™ white Chungking bristles, ZETA cloth, white Scotch Brite™ soie de Tchong King blanche, tissu ZETA, disques de Scotch Brite™ blanche cerda de Chung King blanca, paño ZETA, entretelas de Scotch Brite™ blanca setola di Chungking bianca, panno ZETA, strati di Scotch Brite™ bianco</p> 	8280	80	40	14
<p>weiße Chungking Borsten, weißes Scotch Brite™ white Chungking bristles, white Scotch Brite™ soie de Tchong King blanche, disques de Scotch Brite™ blanche cerda de Chung King blanca, entretelas de Scotch Brite™ blanca setola di Chungking bianca, strati di Scotch Brite™ bianco</p> 	9245	45	25	13
	9255	55	25	13
	9280	80	40	14





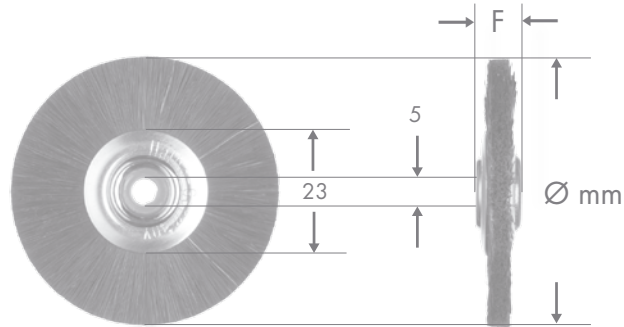















Schmalbürsten
Slimline Brushes
Brosses au centre métallique
Cepillos de forma estrecha
Spazzole con centro metallico



Besatzmaterial
 filling material
 matériel de garniture
 guarnición
 materiale utilizzato











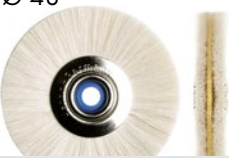

	Ø 36	Ø 42	Ø 48	Ø 51	Ø 60
weißes Ziegenhaar white goat hair poils de chèvre blancs pelo de cabra blanco pelo di capra bianco ↻ 2.800					
		100 42	100 48	100 51	100 60
schwarze Chungking Borsten black Chungking bristles soie de Tchong King noire cerda de Chung King negra setola di Chungking nera ↻ 2.800					
	121 36	121 42	121 48	121 51	121 60
weiße Chungking Borsten white Chungking bristles soie de Tchong King blanche cerda de Chung King bianca setola di Chungking bianca ↻ 2.800					
		120 42	120 48	120 51	120 60
grober Baumwollfaden coarse cotton thread fil de coton dur hilo de algodón grueso filo di cotone grosso ↻ 1.400					
		150 42	150 48	150 51	150 60



	Ø 36	Ø 42	Ø 48	Ø 51	
graues Pferdehaar grey horse hair crins de cheval gris crin de caballo gris crine di cavallo grigio 2.800			 112 48		
graues Ziegenhaar grey goat hair poils de chèvre gris pelo de cabra gris pelo di capra grigio 2.800			 102 48		
gewellter Messingdraht crimped brass wire fil de laiton ondulé alambre de latón ondulado filo di ottone ondulado 1.400 Ø 0,10 mm		 143 42	 143 48	 143 51	
gewellter Edelstahlbraht crimped stainless steel wire fil d'acier inoxydable ondulé alambre de acero inoxidable ondulado filo d'acciaio inossidabile ondulado 1.400 Ø 0,06 mm Ø 0,10 mm	 181 36		 181 48	 183 51	
glatter Edelstahlbraht straight stainless steel wire fil d'acier inoxydable lisse alambre de acero inoxidable liso filo d'acciaio inossidabile liscio 1.400 Ø 0,08 mm				 682 51	
gewellter Stahldraht crimped steel wire fil d'acier ondulé alambre de acero ondulado filo d'acciaio ondulado 1.400 Ø 0,10 mm				 193 51	
	Ø 32	Ø 38	Ø 51		
Nylonfaser Nylon filament fibres de nylon fibra de nylon fibra di nylon 2.800 Ø 0,15 mm Ø 0,30 mm	 282 32	 282 38	 282 51 286 51		

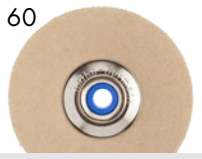

Schmalbürsten
Slimline Brushes
Brosses au centre métallique
Cepillos de forma estrecha
Spazzole con centro metallico

<p>Ziegenhaar Microfaser Leder goat hair microfiber leather poils de chèvre et cuir microfibre pelo de cabra cuero de microfibra pelo di capra pelle in microfibra</p> <p>∪ 2.800</p>	<p>∅ 48</p>  <p>100/520 48</p>	<p>12</p>	<p>Scotch Brite™ Scotch Brite™ Scotch Brite™ Scotch Brite™ Scotch Brite™</p> <p>grob coarse dur grueso grosso</p> <p>∪ 1.400</p>	<p>∅ 51</p>  <p>250 51</p>	<p>2</p>
	<p>∅ 51</p>  <p>100/520 51</p>			<p>ohne Schleifmittel no abrasives sans grain sin grano senza grana</p> <p>∪ 1.400</p>	
<p>schwarze Chungking Borsten Nesselstoff Einlage black Chung King bristles muslin insert soie de Tchong King noir et mousseline cerda de Chung King negra intermedia de muselina Setola di Chungking nera con strato di mussola</p> <p>∪ 2.800</p>	<p>∅ 48</p>  <p>121 48 NE</p>	<p>∪ 1.400</p>	<p>grob gebunden coarse bonded dur lié gruesa ligado grana grossa</p> <p>∪ 1.400</p>	<p>∅ 51</p>  <p>254 51</p>	
	<p>schwarze Chungking Borsten weißem Scotch Brite™ black Chung King bristles with white Scotch Brite™ discs soie de Tchong King noir et avec Scotch Brite™ blanc cerda de Chung King negra intermedia de Scotch Brite™ blanco Setola di Chungking nera con strato intermedio di Scotch Brite™ bianco</p> <p>∪ 2.800</p>			<p>∅ 48</p>  <p>121 48 VL</p>	<p>Mikrofaser-Leder microfiber leather discs cuir de microfibre cuero de microfibra pelle in microfibra</p> <p>∪ 1.400</p>
<p>Nesselstoff muslin cloth disques en toile muselina mussola tinta</p> <p>∪ 2.800</p>	<p>∅ 48</p>  <p>164 48</p>	<p>COSIMA soft</p> <p>Weiches silikoniertes Baumwollgewebe soft silicon coated cotton fabric tissu de coton doux et siliconé tejido blando de algodón siliconado tessuto di cotone siliconato morbido</p> <p>∪ 1.400</p>	<p>∅ 51</p>  <p>869 51</p>		
	<p>Wildleder chamois leather peau de chamois cuero de gamuza pelle di camoscio</p> <p>∪ 1.400</p>		<p>∅ 51</p>  <p>500 51</p>	<p>∅ 60</p>  <p>869 60</p>	
<p>∪ 1.400</p>	<p>∅ 60</p>  <p>500 60</p>	<p>COSIMA</p> <p>Silikoniertes Baumwoll- gewebe silicon coated cotton fabric tissu de coton siliconé tejido de algodón siliconado tessuto di cotone siliconato</p> <p>∪ 1.400</p>	<p>∅ 51</p>  <p>870 51</p>		
	<p>∪ 1.400</p>		<p>∅ 60</p>  <p>870 60</p>		

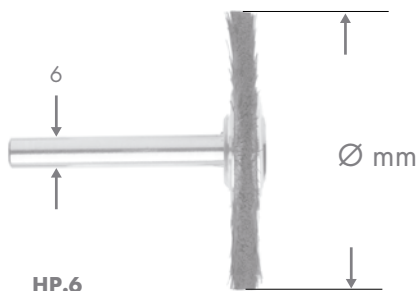

HP.6

∅ 1.400	∅ 51	∅ 1.400	∅ 51
<p>weißes Ziegenhaar weich white goat hair soft poils de chèvre blancs pelo de cabra blanco pelo di capra bianco</p>	 <p>100 51 HP.6</p>	<p>schwarze Chungking Borste black Chungking bristles soie de Tchong King noire cerda de Chung King negra setola di Chungking nera</p>	 <p>121 51 HP.6</p>
<p>Baumwollfaden cotton thread fil de coton hilo de algodón filo di cotone</p>	 <p>150 51 HP.6</p>	<p>gewellter Edelstahlraht crimped stainless steel wire fil d'acier inoxydable ondulé alambre de acero inoxidable ondulado filo d'acciaio inossidabile ondulato</p> <p>∅ 0,10 mm</p>	 <p>183 51 HP.6</p>
<p>gewellter Stahdraht crimped steel wire fil d'acier ondulé alambre de acero ondulado filo d'acciaio ondulato</p> <p>∅ 0,10 mm</p>	 <p>193 51 HP.6</p>	<p>Nylonfaser Nylon filament fibres de nylon fibra de nylon fibra di nylon</p> <p>∅ 0,15 mm</p>	 <p>282 51 HP.6</p>
<p>Wildleder chamois leather peau de chamois cuero de gamuza pelle di camoscio</p>	 <p>500 51 HP.6</p>	<p>Edelstahdraht glatt straight stainless steel wire fil d'acier inoxydable lisse alambre de acero inoxidable liso filo d'acciaio inossidabile liscio</p> <p>∅ 0,08 mm</p>	 <p>682 51 HP.6</p>
<p>gewellter Messingdraht crimped brass wire fil de laiton ondulé alambre de latón ondulado filo di ottone ondulato</p> <p>∅ 0,10 mm</p>	 <p>143 51 HP.6</p>	<p>Scotch Brite™ fein Scotch Brite™ fine Scotch Brite™ fin Scotch Brite™ fino Scotch Brite™ fine</p>	 <p>252 51 HP.6</p>
<p>∅ 1.400</p> <p>gewellter Stahdraht crimped steel wire fil d'acier ondulé alambre de acero ondulado filo d'acciaio ondulato</p> <p>∅ 0,10 mm</p>	<p>∅ 45</p>  <p>193 45 HP.6</p>	<p>∅ 1.400</p> <p>gewellter Messingdraht crimped brass wire fil de laiton ondulé alambre de latón ondulado filo di ottone ondulato</p> <p>∅ 0,15 mm</p>	<p>∅ 60</p>  <p>145 60 HP.6</p>







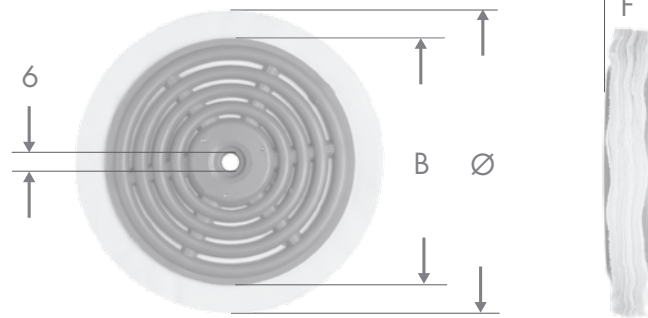

Polierschwabbeln
Polishing Discs
Disques de polissage
Discos de pulido
Dischi per lucidare



LZ = Lagenzahl
 number of layers
 nombre de disques
 numero de hiladas
 numero dei dischi

Ø 110 = ∅ 1.400 Ø 80 = ∅ 2.800



Art.Nr. art.No.	Material material	Ø mm	B mm	F mm	LZ	
	Nesselschwabbel muslin discs brosse en mousseline discos de muselina spazzola in mussola	110	90	20	45	
		160 110 NE/45	110	90	18	30
		160 80 NE/45	80	63	20	45
		160 80 NE/30	80	63	18	30
	Filztuchschwabbel felt cloth discs brosse en feutre discos de fieltro spazzola in feltro	110	90	28	12	
		162 110 FI/12	110	90	18	6
		162 80 FI/12	80	63	28	12
		162 80 FI/6	80	63	18	6
	Wildlederschwabbel chamois leather discs brosse en peau de chamois cuero de gamuza spazzola in camoscio	110	90	23	12	
		500 110 CH/12	110	90	18	6
		500 80 CH/12	80	63	23	12
		500 80 CH/6	80	63	18	6
	Microfaser Leder microfiber leather cuir de microfibre cuero de microfibra pelle in microfibra	110	90	19	12	
		520 110 CH/12	110	90	16	6
		520 80 CH/12	80	63	19	12
		520 80 CH/6	80	63	16	6

Schleifvliesräder mit Scotch Brite™
 Trimming Wheels with Scotch Brite™
 Roues d'affilage en Scotch Brite™ abrasive
 Muelas abrasivas Scotch Brite™
 Dischi abrasivi in Scotch Brite™

VL/2



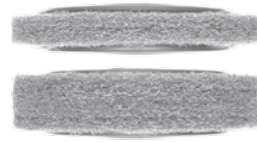







VL/4

















Ø 110 = ∪ 1.400 Ø 80 = ∪ 2.800







	Art.Nr. art.No.	Material material	Ø mm	B mm	F mm	LZ
	259 110 VL/4	extra grob extra coarse extra dur extra grueso extra grossa	110	90	44	4
	259 110 VL/2		110	90	26	2
	259 80 VL/4		80	63	40	4
	259 80 VL/2		80	63	26	2
	250 110 VL/4	grob coarse dur grueso grossa	110	90	33	4
	250 110 VL/2		110	90	23	2
	250 80 VL/4		80	63	29	4
	250 80 VL/2		80	63	18	2
	251 110 VL/4	mittel medium medium medio media	110	90	31	4
	251 110 VL/2		110	90	23	2
	251 80 VL/4		80	63	30	4
	251 80 VL/2		80	63	21	2
	252 110 VL/4	fein fine fin fino fine	110	90	30	4
	252 110 VL/2		110	90	21	2
	252 80 VL/4		80	63	25	4
	252 80 VL/2		80	63	18	2
	255 110 VL/4	fein fine fin fino fine	110	90	30	4
	255 110 VL/2		110	90	21	2
	255 80 VL/4		80	63	25	4
	255 80 VL/2		80	63	18	2
	253 110 VL/4	ohne Schleifmittel without abrasive sans grain sin grano senza grana	110	90	28	4
	253 110 VL/2		110	90	18	2
	253 80 VL/4		80	63	26	4
	253 80 VL/2		80	63	18	2





	Art.Nr. art.No.	Material material	Ø mm	B mm	F mm	LZ
	165 100 Pli	plissierte Nesselschwabbel pleated muslin discs brosse en mousseline plissée discos de muselina plisada spazzola in mussola plisseffata	100	45	18	-
	166 100 F	Nesselfaltschwabbel muslin discs slight pleats brosse en mousseline avec plis discos de muselina con arrugas spazzola in mussola arricciata	100	43	16	-
	168 100 F	Flanellfaltschwabbel flannel brush with slight pleats brosse en flanelle avec plis discos de franela con arrugas spazzola in flanela arricciata	100	43	16	-
	168 80 F		80	43	16	-
	 161 100/20	Flanellschwabbel flannel discs brosse en flanelle discos de franela spazzola in flanela	100	40	17	20
	 162 100/6	Filztuchschwabbel felt cloth discs brosse en feutre discos de fieltro spazzola in feltro	100	40	18	6
	 163 100/40	Feinstes Baumwoll- gewebe finest cotton fabric toile de coton très fine tejido de algodón muy fino tessuto di cotone molto fino	100	40	16	40
	 164 100/20	gebleichte Nesselschwabbel bleached muslin discs disque de mousseline blanchie cepillo de muselina blanqueada disco in mussola tinta	100	40	15	20
	164 100/40		100	40	18	40
	164 100/55		100	40	20	55

	Art.Nr. art.No.	Material material	Ø mm	B mm	F mm	LZ				
	 500 100/7	Wildlederschwabbel chamois leather discs brosse en peau de chamois cuero de gamuza spazzola in camoscio	100	40	16	7				
	 500 80/7						80	40	19	7
	 500 90 LE	Wildlederschwabbel chamois leather discs brosse en peau de chamois cuero de gamuza spazzola in camoscio	90	40	18	-				
	 520 100/7	Microfaserleder microfiber leather discs cuir de microfibre cuero de microfibra pelle in microfibra	100	40	15	7				
	 520 90 LE	Microfaserleder microfiber leather discs cuir de microfibre cuero de microfibra pelle in microfibra	90	40	18	-				
	ZETA  862 100/15	Microfaser microfiber microfibre microfibra microfibra	100	40	15	15				
	COSIMA Soft  869 100/14	Weiches silikonisiertes Baumwollgewebe soft silicon coated cotton fabric tissu de coton doux et siliconé tejido blando de algodón siliconado tessuto di cotone siliconato morbido	100	40	10	14				
	869 100/20						100	40	13	20
	869 100/28						100	40	20	28
	COSIMA  870 100/14	Silikonisiertes Baumwoll- gewebe silicon coated cotton fabric tissu de coton siliconé tejido de algodón siliconado tessuto di cotone siliconato	100	40	12	14				
	870 100/22						100	40	20	22



	Art.Nr. art.No.	Material material	Ø mm	B mm	F mm
	873 125x24 K	Dichtes Baumwollge- webe dense fine cotton fabric toile dense de coton tejido de algodón denso tessuto di cotone fitto	125	51	24
	873 125x30 K		125	51	30
	163 125x24 K	Feinstes Baumwoll- gewebe finest cotton fabric toile de coton très fine tejido de algodón muy fino tessuto di cotone molto fino	125	51	24
	163 125x30 K		125	51	30
	161 125x24 K	Weiches Baumwollgewebe soft fine cotton fabric toile de coton fine et doux tejido de algodón blando tessuto di cotone morbido	125	51	24
	161 125x30 K		125	51	30
	162 125x24 K	Gewalkte Schafswolle felted lamb´s wool laine de mouton feutrée lana de oveja abatanada lana di pecora infeltrita	125	51	24
	162 125x30 K		125	51	30
	520 125x24 K	Mikrofaserleder microfiber leather discs cuir de microfibre cuero de microfibra pelle in microfibra	125	51	24
	520 125x30 K		125	51	30

	Art.Nr. art.No.	Material material	Ø mm	B mm	F mm	LZ
	160 125x24 K	Grobes Baumwollgewebe coarse cotton fabric toile de coton dur tejido de algodón grueso tessuto di cotone grossolano	125	51	24	
	160 125x30 K		125	51	30	
	COSIMA Soft	Weiches silikoniertes Baumwollgewebe soft silicon coated cotton fabric tissu de coton doux et siliconé tejido blando de algodón siliconado tessuto di cotone siliconato morbido				
	869 125x24 K		125	51	24	
	869 125x30 K	125	51	30		
	COSIMA	Silikoniertes Baumwollgewebe silicon coated cotton fabric tissu de coton siliconé tejido de algodón siliconado tessuto di cotone siliconato				
	870 125x24 K		125	51	24	
	870 125x30 K	125	51	30		
	169 125/90 K	Inletschwabbel fine cloth discs brosse avec toile fine cepillo de tela fina spazzola in tela fine	125	51	19	90
	169 150/90 K		150	51	19	90
	167 100/10 K	Nesselfaltschwabbel muslin discs slight pleats brosse en mousseline avec plis discos de muselina con arrugas spazzola in mussola arricciata	100	42	10	10
	167 100/20 K		100	42	22	20
	167 100/30 K		100	51	33	30
	ZETA	Microfaser microfiber microfibre microfibra microfibra				
	862 125 x 20 K	125	50	20	50	

	Art.Nr. art.No.	Material material	Ø mm	B mm	F mm
	156 50 H		50	20	15
	156 60 H		60	25	17
	156 70 H		70	28	18
	156 80 H	Baumwollmullen mit Holzkern cotton buffs with wooden core grosse brosse en coton avec centre en bois cepillo con centro de madera filo di cotone con centro in legno	80	33	23
	156 90 H		90	35	20
	156 100 H		100	40	20
		156 80/6 HS	sehr feiner Faden very fine thread fil de coton très fin hilo de algodón muy fino filo di cotone molto fine	80	40
156 80/4 HS			80	40	27
 150 80 BW		grober Faden coarse cotton thread fil de coton dur hilo de algodón grueso filo di cotone grosso	80	40	18
 152 80 BW		feiner Faden fine thread fil de coton fin hilo de algodón fino filo di cotone fine	80	40	18

MIRA Schwabbeln
MIRA Buffs
Disques MIRA
Discos MIRA
Spazzole MIRA

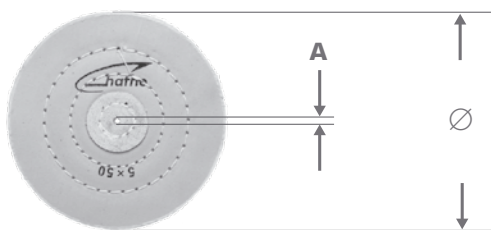

A = 6 mm (Standard) oder/or A = 15 mm

LZ = Lagenzahl
 number of layers
 nombre de disques
 numero de hiladas
 numero dei dischi

H
 ungenäht · unstitched
 non cousue · no cosido
 non cucito

HG
 genäht · stitched
 cousue · cosido
 cucito

2" / 3" / 4" = ∅ 2.800

5" / 6" = ∅ 1.400



		Art.Nr. art.No.	Material material	Ø mm	F mm	LZ
		661 4"x 50 H	grober Baumwollstoff coarse cotton cloth tissu de coton dur tela de algodón grueso tessuto di cotone grossolano	100	13	50
		661 4"x 50 HG		100	13	50
		661 6"x 50 H		150	13	50
		661 6"x 50 HG		150	13	50
		867 2"x 50 HG	gelb getränkter feiner Baumwollstoff yellow treated fine cotton cloth tissu de coton imprégné jaune tela de algodón fina con teñido de amarillo tessuto di cotone fine impregnato di colore giallo	50	15	50
		867 3"x 50 HG		75	15	50
		867 4"x 50 H		100	15	50
		867 4"x 50 HG		100	15	50
		867 5"x 50 HG		125	15	50
		867 6"x 50 H		150	15	50
		867 6"x 50 HG		150	15	50
		867 6"x 60 HG		150	15	60
		868 4"x 50 H	feiner Baumwollstoff fine cotton cloth tissu de coton fin tela de algodón fina tela di cotone fine	100	15	50
		868 4"x 50 HG		100	15	50
		868 5"x 50 HG		125	15	50
		868 6"x 50 H		150	15	50
		868 6"x 75 H		150	15	75
		868 6"x 50 HG		150	15	50
	868 6"x 60 HG	150	15	60		



**HABRAS Bürsten, HABRAS Disc
HABRAS Brushes, HABRAS Disc
Brosses HABRAS, HABRAS Disc
Cepillos HABRAS, HABRAS Disc
HABRAS Spazzole, HABRAS Disc**

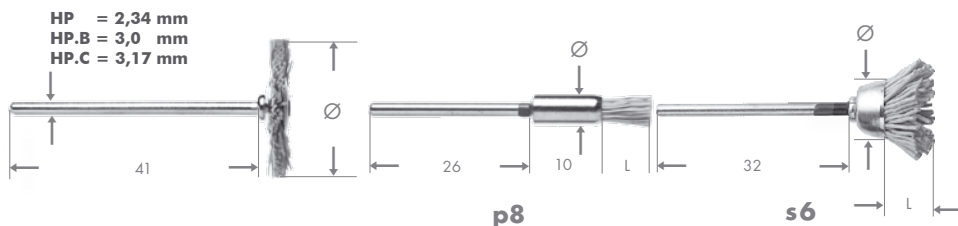

Besatzmaterial: Polyamidfaser mit eingebettetem Schleifkorn
filling material: abrasive filament
matériel de garniture: fil de polyamide avec grain abrasif
guarnición: fibra de poliamida incluido el grano
materiale utilizzato: fibra di poliammide con grana abrasive incorporate

10.000

	Ø mm	L mm	Korn grit	HP	HP.B	HP.C
	10	6	AO fein fine fin fino fine 600 Ø 0,30	400 s6 HP	400 s6 HPB	400 s6 HRC
	19			400 19 HP	400 19 HPB	400 19 HRC
	22			400 22 HP	400 22 HPB	400 22 HRC
	25			400 25 HP	400 25 HPB	400 25 HRC
	5	8		400 p8 HP	400 p8 HPB	400 e8 HRC
	10	6	AO mittel medium medium medio media 500 Ø 0,50	402 s6 HP	402 s6 HPB	402 s6 HRC
	19			402 19 HP	402 19 HPB	402 19 HRC
	22			402 22 HP	402 22 HPB	402 22 HRC
	25			402 25 HP	402 25 HPB	402 25 HRC
	5	8		402 p8 HP	402 p8 HPB	402 e8 HRC
	10	6	AO grob coarse dur grueso grossa 320 Ø 0,50	404 s6 HP	404 s6 HPB	404 s6 HRC
	19			404 19 HP	404 19 HPB	404 19 HRC
	22			404 22 HP	404 22 HPB	404 22 HRC
	25			404 25 HP	404 25 HPB	404 25 HRC
	5	8		404 p8 HP	404 p8 HPB	404 e8 HRC
	10	6	SIC extra fein extra fine extra fin extra fino extra fine 800 Ø 0,25	800 s6 HP	800 s6 HPB	800 s6 HRC
	19			800 19 HP	800 19 HPB	800 19 HRC
	22			800 22 HP	800 22 HPB	800 22 HRC
	25			800 25 HP	800 25 HPB	800 25 HRC
	5	8		800 p8 HP	800 p8 HPB	800 e8 HRC
	10	6	SIC mittel medium medium medio media 500 Ø 0,50	410 s6 HP	410 s6 HPB	410 s6 HRC
	19			410 19 HP	410 19 HPB	410 19 HRC
	22			410 22 HP	410 22 HPB	410 22 HRC
	25			410 25 HP	410 25 HPB	410 25 HRC
	5	8		410 p8 HP	410 p8 HPB	410 e8 HRC
	10	6	SIC grob coarse dur grueso grossa 320 Ø 0,56	420 s6 HP	420 s6 HPB	420 s6 HRC
	19			420 19 HP	420 19 HPB	420 19 HRC
	22			420 22 HP	420 22 HPB	420 22 HRC
	25			420 25 HP	420 25 HPB	420 25 HRC
	5	8		420 p8 HP	420 p8 HPB	420 e8 HRC



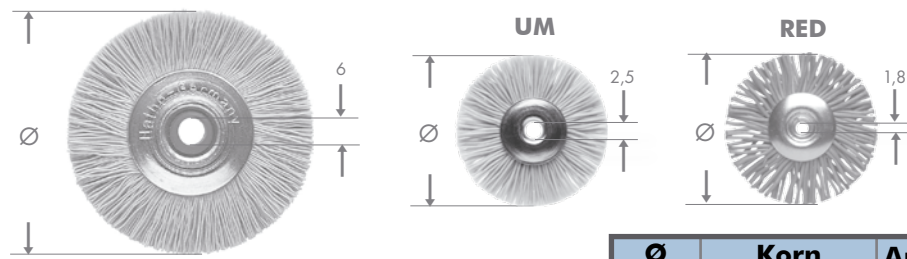

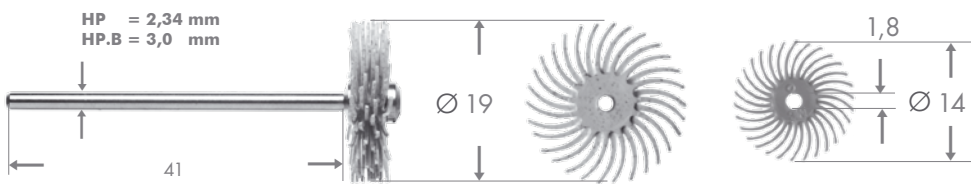

2.800 10.000		Ø mm	Korn grit	Art.Nr. art.No.			
		19	AO fein fine fin fino fine	400 19 UM			
		22		400 22 UM			
		42		400 42			
		51		400 51			
		22	600	400 22 RED			
				Ø 0,30			
				19	AO mittel medium medium medio media	402 19 UM	
				22		402 22 UM	
42	402 42						
51	402 51						
		22	500	402 22 RED			
				Ø 0,50			
				19	AO grob coarse dur grueso grossa	404 19 UM	
				22		404 22 UM	
42	404 42						
51	404 51						
		22	320	404 22 RED			
				Ø 0,50			
				19	SIC extra fein extra fine extra fin extra fino extra fine	800 19 UM	
				22		800 22 UM	
42	800 42						
51	800 51						
		22	800	800 22 RED			
				Ø 0,25			
				19	SIC mittel medium medium medio media	410 19 UM	
				22		410 22 UM	
42	410 42						
51	410 51						
		22	500	410 22 RED			
				Ø 0,50			
				19	SIC grob coarse dur grueso grossa	420 19 UM	
				22		420 22 UM	
42	420 42						
51	420 51						
		22	320	420 22 RED			
				Ø 0,56			



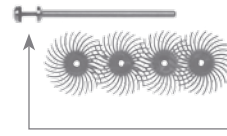

Kunststoffscheibe mit eingebettetem Schleifkorn
Acrylic disc with embedded abrasives
Disque en plastique avec grain abrasif intégré
Disco de plástico con grano incluido
Disco in plastica con grana incorporata

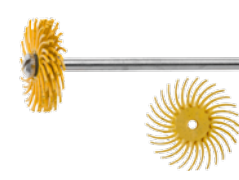

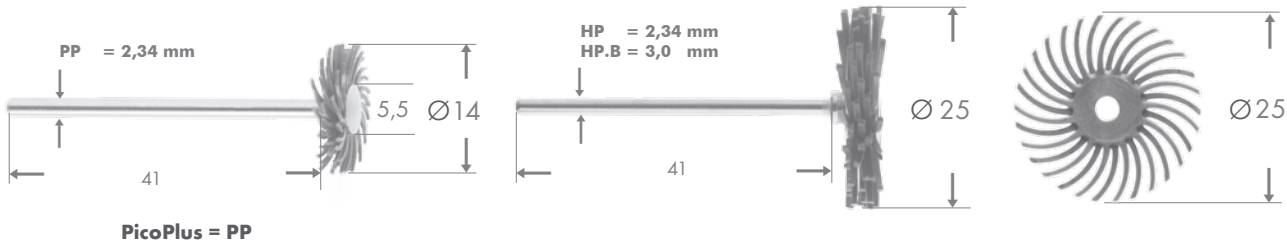
				5.000		 Ø 14 mm Ø 19 mm	
Körnung grit	Charakter character			Ø 14 mm	Ø 19 mm		
901	Korund Corundum Corindon Corindón Corindone	grob 80				901 19 HP 901 19 HRB 901 19 R/4 901 19 R/48	
905		mittel 120			905 14 HP 905 14 HRB 905 14 R/4 905 14 R/48	905 19 HP 905 19 HRB 905 19 R/4 905 19 R/48	
902		standard 220			902 14 HP 902 14 HRB 902 14 R/4 902 14 R/48	902 19 HP 902 19 HRB 902 19 R/4 902 19 R/48	
903		fein 400			903 14 HP 903 14 HRB 903 14 R/4 903 14 R/48	903 19 HP 903 19 HRB 903 19 R/4 903 19 R/48	
904		sehr fein very fine très fin muy fino molto fine			904 14 HP 904 14 HRB 904 14 R/4 904 14 R/48	904 19 HP 904 19 HRB 904 19 R/4 904 19 R/48	
906		extra fein 6 µm extra fine extra fin extra fino extra fine				906 19 HP 906 19 HRB 906 19 R/4 906 19 R/48	
907		ultra fein 1 µm ultra fine ultra fin ultra fino ultra fine			907 14 HP 907 14 HRB 907 14 R/4 907 14 R/48	907 19 HP 907 19 HRB 907 19 R/4 907 19 R/48	



			5.000	Ø 14 mm	
905	Korund Corundum Corindon Corindón Corindone	mittel medium medio media	120		905.1 14 PP
903		fein fine fin fino fine	400		903.2 14 PP
904	Bimsstein Pumice Pierre ponce Pómez Pomice	sehr fein very fine très fin muy fino molto fine			904.3 14 PP



HABRAS Disc Pro DCS Kit 14









HP



R/4



R/48

			5.000	Ø 25 mm	
909	Korund Corundum Corindon Corindón Corindone	extra grob extra coarse extra dur extra grueso extra grossa	36		909 25(3)HP 909 25(3)HRB 909 25 R/4 909 25 R/48
908		sehr grob very coarse très dur muy grueso molto grossa	50		908 25(3)HP 908 25(3)HRB 908 25 R/4 908 25 R/48
901		grob coarse dur grueso grossa	80		901 25(3)HP 901 25(3)HRB 901 25 R/4 901 25 R/48
905		mittel medium medio media	120		905 25(3)HP 905 25(3)HRB 905 25 R/4 905 25 R/48
902		standard standard standard estándar standard	220		902 25(3)HP 902 25(3)HRB 902 25 R/4 902 25 R/48
903		fein fine fin fino fine	400		903 25(3)HP 903 25(3)HRB 903 25 R/4 903 25 R/48



HABRAS Discs Kit 14

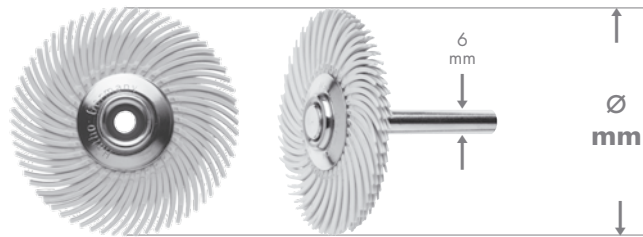

HABRAS Discs Kit 19

 1.400

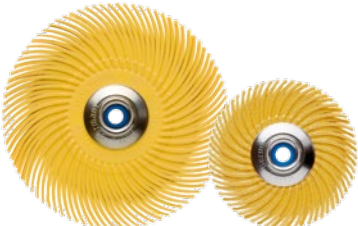
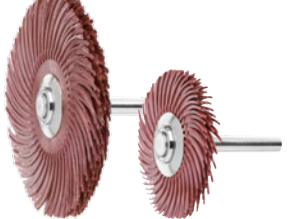
	Art.Nr. art.No.	Ø mm	Körnung	Charakter character		
	901 76x4	76	Korund Corundum Corindon Corindón Corindone	80 grob coarse dur grueso grossa		
	901 51x4	51				
	901 76x4 HR6	76				
	901 51x4 HR6	51				
	905 76x4	76			Korund Corundum Corindon Corindón Corindone	120 mittel medium medio media
	905 51x4	51				
	905 76x4 HR6	76				
	905 51x4 HR6	51				
	902 76x4	76	Korund Corundum Corindon Corindón Corindone	220 standard standard standard estándar standard		
	902 51x4	51				
	902 76x4 HR6	76				
	902 51x4 HR6	51				





1.400



	Art.Nr. art.No.	Ø mm	Körnung grit	Charakter character
	903 76x4	76	Korund Corundum Corindon Corindón Corindone 400	fein fine fin fino fine
	903 51x4	51		
	903 76x4 HP6	76		
	903 51x4 HP6	51		
	904 76x4	76	Bimsstein Pumice Pierre ponce Pómez Pomice	sehr fein very fine très fin muy fino molto fine
	904 51x4	51		
	904 76x4 HP6	76		
	904 51x4 HP6	51		
	906 76x4	76	Edelkorund High grade corundum Corindon de haute qualité Corindón especial Corindone di qualità	extra fein extra fine extra fin extra fino extra fine
	906 51x4	51		
	906 76x4 HP6	76	6µm	
	906 51x4 HP6	51		
	907 76x4	76	Edelkorund High grade corundum Corindon de haute qualité Corindón especial Corindone di qualità	ultra fein ultra fine ultra fin ultra fino ultra fine
	907 51x4	51		
	907 76x4 HP6	76	1µm	
	907 51x4 HP6	51		



Miniaturbürsten
Miniature Brushes
Brossettes Miniatures
Cepillos Miniaturas
Spazzole Miniatur

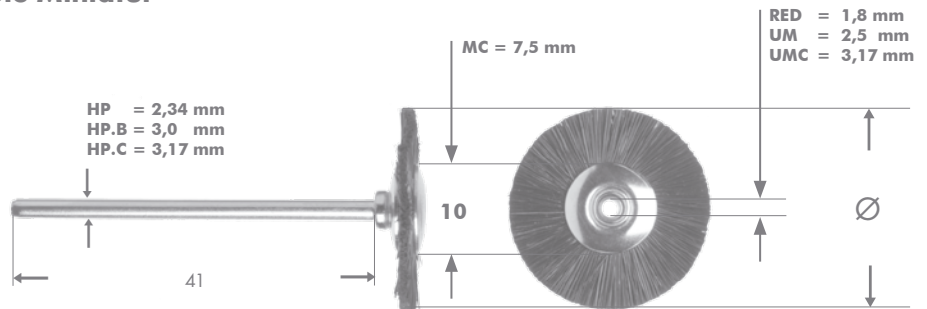















Besatzmaterial
 filling material
 matériel de garniture
 guarnición
 materiale utilizzato 10.000

	Ø	HP	HP.B	HP.C		RED	UM	UMC
weißes Ziegenhaar · white goat hair · poils de chèvre blancs · pelo de cabra blanco · pelo di capra bianco								
	16	100 16 HP	100 16 HP.B	100 16 HP.C		100 16 RED	100 16 UM	100 16 UMC
	19	100 19 HP	100 19 HP.B	100 19 HP.C		100 19 RED	100 19 UM	100 19 UMC
	22	100 22 HP	100 22 HP.B	100 22 HP.C		100 22 RED	100 22 UM	100 22 UMC
graues Ziegenhaar · grey goat hair · poils de chèvre gris · pelo de cabra gris · pelo di capra grigio								
	16	102 16 HP	102 16 HP.B	102 16 HP.C		102 16 RED	102 16 UM	102 16 UMC
	19	102 19 HP	102 19 HP.B	102 19 HP.C		102 19 RED	102 19 UM	102 19 UMC
	22	102 22 HP	102 22 HP.B	102 22 HP.C		102 22 RED	102 22 UM	102 22 UMC
graues Pferdehaar · grey horse hair · crins de cheval gris · crin de caballo gris · crine di cavallo grigio								
	16	112 16 HP	112 16 HP.B	112 16 HP.C		112 16 RED	112 16 UM	112 16 UMC
	19	112 19 HP	112 19 HP.B	112 19 HP.C		112 19 RED	112 19 UM	112 19 UMC
	22	112 22 HP	112 22 HP.B	112 22 HP.C		112 22 RED	112 22 UM	112 22 UMC
weiße Chungking Borsten · white Chungking bristles · soie de Tchong King blanche · cerda de Chung King blanca · setola di Chungking bianca								
	16	120 16 HP	120 16 HP.B	120 16 HP.C		120 16 RED	120 16 UM	120 16 UMC
	19	120 19 HP	120 19 HP.B	120 19 HP.C		120 19 RED	120 19 UM	120 19 UMC
	22	120 22 HP	120 22 HP.B	120 22 HP.C		120 22 RED	120 22 UM	120 22 UMC
schwarze Chungking Borsten · black Chungking bristles · soie de Tchong King noire · cerda de Chung King negra · setola di Chungking nera								
	16	121 16 HP	121 16 HP.B	121 16 HP.C		121 16 RED	121 16 UM	121 16 UMC
	19	121 19 HP	121 19 HP.B	121 19 HP.C		121 19 RED	121 19 UM	121 19 UMC
	22	121 22 HP	121 22 HP.B	121 22 HP.C		121 22 RED	121 22 UM	121 22 UMC
weißes Ziegenhaar · white goat hair · poils de chèvre blancs · pelo de cabra blanco · pelo di capra bianco								
	16	100 16 (MC) HP	100 16 (MC) HP.B		100 16 (MC) UM			
	19	100 19 (MC) HP	100 19 (MC) HP.B		100 19 (MC) UM			
graues Ziegenhaar · grey goat hair · poils de chèvre gris · pelo de cabra gris · pelo di capra grigio								
	16	102 16 (MC) HP	102 16 (MC) HP.B		102 16 (MC) UM			
	19	102 19 (MC) HP	102 19 (MC) HP.B		102 19 (MC) UM			
weiße Chungking Borsten · white Chungking bristles · soie de Tchong King blanche · cerda de Chung King blanca · setola di Chungking bianca								
	16	120 16 (MC) HP	120 16 (MC) HP.B		120 16 (MC) UM			
	19	120 19 (MC) HP	120 19 (MC) HP.B		120 19 (MC) UM			
schwarze Chungking Borsten · black Chungking bristles · soie de Tchong King noire · cerda de Chung King negra · setola di Chungking nera								
	16	121 16 (MC) HP	121 16 (MC) HP.B		121 16 (MC) UM			
	19	121 19 (MC) HP	121 19 (MC) HP.B		121 19 (MC) UM			

















Besatzmaterial
filling material
matériel de garniture
guarnición
materiale utilizzato

	Draht wire Ø	HP	HP.B	HP.C		RED	UM	UMC
gewellter Stahldraht · crimped steel wire · fil d'acier ondulé · alambre de acero ondulado · filo d'acciaio ondulato								
 Ø 16 mm ↻ 15.000	0,08	192 16 HP	192 16 HP.B	192 16 HP.C		192 16 RED	192 16 UM	192 16 UMC
	0,10	193 16 HP	193 16 HP.B	193 16 HP.C		193 16 RED	193 16 UM	193 16 UMC
	0,12	194 16 HP	194 16 HP.B	194 16 HP.C		194 16 RED	194 16 UM	194 16 UMC
 Ø 19 mm ↻ 12.000	0,08	192 19 HP	192 19 HP.B	192 19 HP.C		192 19 RED	192 19 UM	192 19 UMC
	0,10	193 19 HP	193 19 HP.B	193 19 HP.C		193 19 RED	193 19 UM	193 19 UMC
	0,12	194 19 HP	194 19 HP.B	194 19 HP.C		194 19 RED	194 19 UM	194 19 UMC
 Ø 22 mm ↻ 10.000	0,08	192 22 HP	192 22 HP.B	192 22 HP.C		192 22 RED	192 22 UM	192 22 UMC
	0,10	193 22 HP	193 22 HP.B	193 22 HP.C		193 22 RED	193 22 UM	193 22 UMC
	0,12	194 22 HP	194 22 HP.B	194 22 HP.C		194 22 RED	194 22 UM	194 22 UMC
gewellter Edelstahldraht · crimped stainless steel wire · fil d'acier inoxydable ondulé · alambre de acero inoxidable ondulado · filo d'acciaio inossidabile ondulato								
 Ø 16 mm ↻ 15.000	0,06	181 16 HP	181 16 HP.B	181 16 HP.C		181 16 RED	181 16 UM	181 16 UMC
	0,08	182 16 HP	182 16 HP.B	182 16 HP.C		182 16 RED	182 16 UM	182 16 UMC
	0,10	183 16 HP	183 16 HP.B	183 16 HP.C		183 16 RED	183 16 UM	183 16 UMC
	0,12	184 16 HP	184 16 HP.B	184 16 HP.C		184 16 RED	184 16 UM	184 16 UMC
 Ø 19 mm ↻ 12.000	0,06	181 19 HP	181 19 HP.B	181 19 HP.C		181 19 RED	181 19 UM	181 19 UMC
	0,08	182 19 HP	182 19 HP.B	182 19 HP.C		182 19 RED	182 19 UM	182 19 UMC
	0,10	183 19 HP	183 19 HP.B	183 19 HP.C		183 19 RED	183 19 UM	183 19 UMC
	0,12	184 19 HP	184 19 HP.B	184 19 HP.C		184 19 RED	184 19 UM	184 19 UMC
 Ø 22 mm ↻ 10.000	0,06	181 22 HP	181 22 HP.B	181 22 HP.C		181 22 RED	181 22 UM	181 22 UMC
	0,08	182 22 HP	182 22 HP.B	182 22 HP.C		182 22 RED	182 22 UM	182 22 UMC
	0,10	183 22 HP	183 22 HP.B	183 22 HP.C		183 22 RED	183 22 UM	183 22 UMC
	0,12	184 22 HP	184 22 HP.B	184 22 HP.C		184 22 RED	184 22 UM	184 22 UMC
glatter Edelstahldraht · straight brass wire · fil d'acier inoxydable lisse · alambre de acero inoxidable liso · filo d'acciaio inossidabile liscio								
 Ø 22 mm ↻ 10.000	0,08	682 22 HP	682 22 HP.B	682 22 HP.C		682 22 RED	682 22 UM	



Besatzmaterial
filling material
matériel de garniture
guarnición
materiale utilizzato

	Draht wire Ø	HP	HP.B	HP.C		RED	UM	UMC
gewellter Messingdraht · crimped brass wire · fil de laiton ondulé · alambre de latón ondulado · filo di ottone ondulato								
 Ø 16 mm ↻ 15.000	0,06	141 16 HP	141 16 HP.B	141 16 HP.C		141 16 RED	141 16 UM	141 16 UMC
	0,08	142 16 HP	142 16 HP.B	142 16 HP.C		142 16 RED	142 16 UM	142 16 UMC
	0,10	143 16 HP	143 16 HP.B	143 16 HP.C		143 16 RED	143 16 UM	143 16 UMC
	0,12	144 16 HP	144 16 HP.B	144 16 HP.C		144 16 RED	144 16 UM	144 16 UMC
 Ø 19 mm ↻ 12.000	0,06	141 19 HP	141 19 HP.B	141 19 HP.C		141 19 RED	141 19 UM	141 19 UMC
	0,08	142 19 HP	142 19 HP.B	142 19 HP.C		142 19 RED	142 19 UM	142 19 UMC
	0,10	143 19 HP	143 19 HP.B	143 19 HP.C		143 19 RED	143 19 UM	143 19 UMC
	0,12	144 19 HP	144 19 HP.B	144 19 HP.C		144 19 RED	144 19 UM	144 19 UMC
 Ø 22 mm ↻ 10.000	0,06	141 22 HP	141 22 HP.B	141 22 HP.C		141 22 RED	141 22 UM	141 22 UMC
	0,08	142 22 HP	142 22 HP.B	142 22 HP.C		142 22 RED	142 22 UM	142 22 UMC
	0,10	143 22 HP	143 22 HP.B	143 22 HP.C		143 22 RED	143 22 UM	143 22 UMC
	0,12	144 22 HP	144 22 HP.B	144 22 HP.C		144 22 RED	144 22 UM	144 22 UMC
glatter Messingdraht · straight brass wires · fil de laiton lisse · alambre de latón liso · filo di ottone liscio								
 Ø 19 mm ↻ 10.000	0,08	642 19 HP	642 19 HP.B	642 19 HP.C		642 19 RED	642 19 UM	
	0,08	642 22 HP	642 22 HP.B	642 22 HP.C		642 22 RED	642 22 UM	
Nylonfaser N6 transparent · Nylon filament N6 transparent · fibres de nylon N6 transparent · fibra de nylon N6 trasparente · fibra di nylon N6 trasparente								
 Ø 16 mm ↻ 10.000	0,15	282 16 HP	282 16 HP.B	282 16 HP.C		282 16 RED	282 16 UM	282 16 UMC
	0,20	283 16 HP	283 16 HP.B	283 16 HP.C		283 16 RED	283 16 UM	283 16 UMC
	0,25	284 16 HP	284 16 HP.B	284 16 HP.C		284 16 RED	284 16 UM	284 16 UMC
	0,30	286 16 HP	286 16 HP.B	286 16 HP.C		286 16 RED	286 16 UM	286 16 UMC
	0,40	288 16 HP	288 16 HP.B	288 16 HP.C		288 16 RED	288 16 UM	288 16 UMC
 Ø 19 mm ↻ 8.000	0,15	282 19 HP	282 19 HP.B	282 19 HP.C		282 19 RED	282 19 UM	282 19 UMC
	0,20	283 19 HP	283 19 HP.B	283 19 HP.C		283 19 RED	283 19 UM	283 19 UMC
	0,25	284 19 HP	284 19 HP.B	284 19 HP.C		284 19 RED	284 19 UM	284 19 UMC
	0,30	286 19 HP	286 19 HP.B	286 19 HP.C		286 19 RED	286 19 UM	286 19 UMC
	0,40	288 19 HP	288 19 HP.B	288 19 HP.C		288 19 RED	288 19 UM	288 19 UMC
 Ø 22 mm ↻ 5.000	0,15	282 22 HP	282 22 HP.B	282 22 HP.C		282 22 RED	282 22 UM	282 22 UMC
	0,20	283 22 HP	283 22 HP.B	283 22 HP.C		283 22 RED	283 22 UM	283 22 UMC
	0,25	284 22 HP	284 22 HP.B	284 22 HP.C		284 22 RED	284 22 UM	284 22 UMC
	0,30	286 22 HP	286 22 HP.B	286 22 HP.C		286 22 RED	286 22 UM	286 22 UMC
	0,40	288 22 HP	288 22 HP.B	288 22 HP.C		288 22 RED	288 22 UM	288 22 UMC

GEZA Bürsten
GEZA Brushes
Brosses GEZA
Cepillos GEZA
Spazzole GEZA

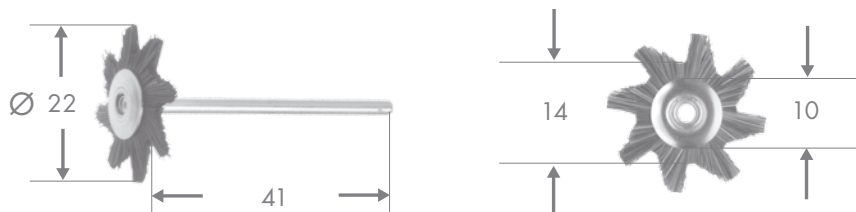

Besatzmaterial
filling material
matériel de garniture
guarnición
materiale utilizzato

10.000

10.000

weißes Ziegenhaar white goat hair poils de chèvre blancs pelo de cabra blanco pelo di capra bianco		GEZA 100 HP		GEZA 100 UM	
weiße Chungking Borsten white Chungking bristles soie de Tchong King blanche cerda de Chung King blanca setola die Chungking bianca		GEZA 120 HP		GEZA 120 UM	
schwarze Chungking Borsten black Chungking bristles soie de Tchong King noire cerda de Chung King negra setola die Chungking nera		GEZA 121 HP		GEZA 121 UM	
graue Chungking Borsten grey Chungking bristles soie de Tchong King gris cerda de Chung King gris setola die Chungking grigia		GEZA 122 HP		GEZA 122 UM	



Kombi Bürsten
Kombi Brushes
Brosses Kombi
Cepillos Kombi
Spazzole Kombi

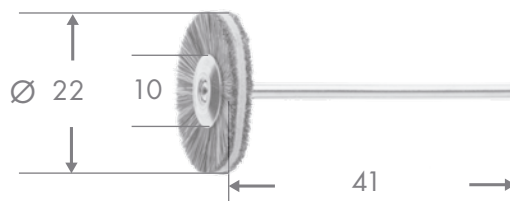

10.000

10.000

weißes Ziegenhaar / Leder white goat hair / leather poils de chèvre blancs / peau de chamois pelo de cabra blanco / cuero de gamuza pelo di capra bianco / pelle di camoscio		100/500 22 HP		graues Ziegenhaar / Leder grey goat hair / leather poils de chèvre gris / peau de chamois pelo de cabra gris / cuero de gamuza pelo di capra grigio / pelle di camoscio	102/500 22 HP
weißes Ziegenhaar / Mikrofaser- Leder white goar hair / microfiber- leather poils de chèvre blancs / cuir synthétique pelo de cabra blanca / cuero de microfibra pelo di capra bianco / pelle in microfibra		100/520 22 HP		graues Ziegenhaar / Mikro- faser-Leder grey goat hair / microfiber- leather poils de chèvre gris/ cuir synthétique pelo de cabra gris / cuero de microfibra pelo di capra grigio / pelle in microfibra	102/520 22 HP
weißes Ziegenhaar / ZETA Tuch white goat hair / ZETA cloth poils de chèvre blancs / tissu ZETA pelo de cabra blanco / paño ZETA pelo di capra bianco / panno ZETA		100/862 22 HP		graues Ziegenhaar / ZETA Tuch grey goat hair / ZETA cloth poils de chèvre gris / tissu ZETA pelo de cabra gris/ paño ZETA pelo di capra grigio / panno ZETA	102/862 22 HP



TORO Bürsten
TORO Brushes
Brossettes TORO
Cepillos TORO
Spazzole TORO

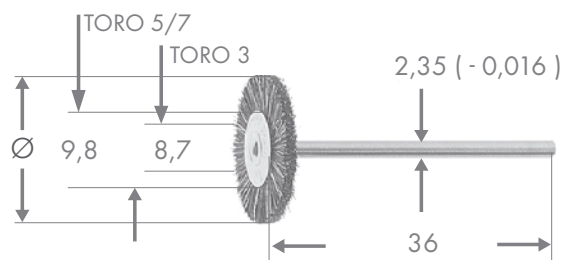

ISO Standard Schaft
 ISO Standard Shank
 Tige Standard ISO
 Vástago ISO estándar
 Mandrino standardizzato ISO

Besatzmaterial
filling material
matériel de garniture
guarnición
materiale utilizzato

10.000



	Ø mm	Ø inch	Art.Nr. art.No.
weißes Ziegenhaar white goat hair poils de chèvre blancs pelo de cabra blanco pelo di capra bianco	14,4	9/16	TORO 3 100
	17,5	11/16	TORO 5 100
	19	3/4	TORO 7 100
graves Ziegenhaar grey goat hair poils de chèvre gris pelo de cabra gris pelo di capra grigio	14,4	9/16	TORO 3 102
	17,5	11/16	TORO 5 102
	19	3/4	TORO 7 102
silbergraves Pferdehaar standard hard silvergrey horse hair standard hard crins de cheval gris argent standard dur crin de caballo gris argentado standard duro crine di cavallo grigio argentato standard duro	14,4	9/16	TORO 3 115
	17,5	11/16	TORO 5 115
	19	3/4	TORO 7 115
Pferdehaar extra hart horse hair extra hard crins de cheval extra dur crin de caballo extra duro crine di cavallo extra duro	14,4	9/16	TORO 3 114
	17,5	11/16	TORO 5 114
	19	3/4	TORO 7 114

ASTRO Bürsten
ASTRO Brushes
Brossettes ASTRO
Cepillos ASTRO
Spazzole ASTRO

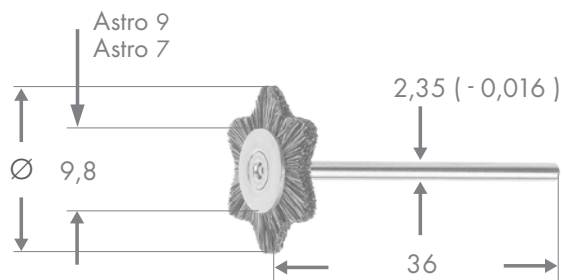

ISO Standard Schaft
 ISO Standard Shank
 Tige Standard ISO
 Vástago ISO estándar
 Mandrino standardizzato ISO

Besatzmaterial
 filling material
 matériel de garniture
 guarnición
 materiale utilizzato

10.000



	Ø mm	Ø inch	Art.Nr. art.No.
weißes Ziegenhaar white goat hair poils de chèvre blancs pelo de cabra blanco pelo di capra bianco	19	3/4	ASTRO 7 100
	22	7/8	ASTRO 9 100
graues Ziegenhaar grey goat hair poils de chèvre gris pelo de cabra gris pelo di capra grigio	19	3/4	ASTRO 7 102
	22	7/8	ASTRO 9 102
silbergraues Pferdehaar standard hart silvergry horse hair standard hard crins de cheval gris argent standard dur crin de caballo gris argentado standard duro crine di cavallo grigio argentato standard duro	19	3/4	ASTRO 7 115
	22	7/8	ASTRO 9 115
Pferdehaar extra hart horse hair extra hard crins de cheval extra dur crin de caballo extra duro crine di cavallo extra duro	19	3/4	ASTRO 7 114
	22	7/8	ASTRO 9 114



Minischleifvliesräder mit Scotch Brite™
Mini Trimming Wheels with Scotch Brite™
Roues mini d'affilage en toison abrasive avec Scotch Brite™
Micromuelas abrasivas Scotch Brite™
Mini routine abrasive in Scotch Brite™

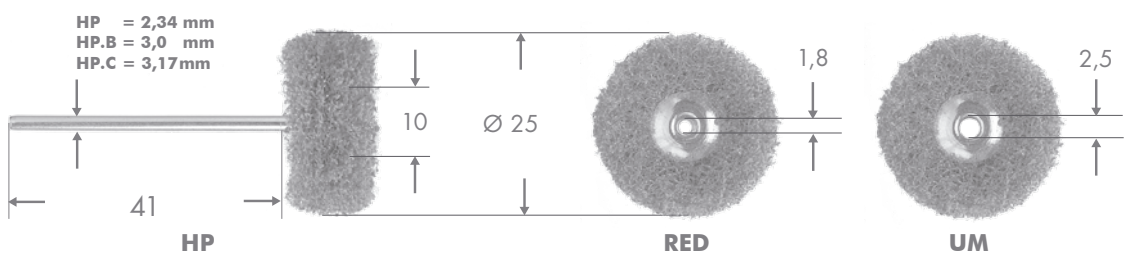

10.000

mesh	Art.Nr. art.No.	Art.Nr. art.No.	Korn grit	Charakter character	Color	
80	259 25 HP		SIC	extra grob extra coarse extra dur extra grueso extra grossa	Dunkel Braun Dark Brown Marron Foncé Marron oscuro Marrone scuro	
	259 25 HP.B					259 25 RED
	259 25 HP.C					259 25 UM
120	258 25 HP		SIC	super grob super coarse super dur super grueso super grossa	Schwarz Black Noir Negro Nero	
	258 25 HP.B					258 25 RED
	258 25 HP.C					258 25 UM
220	250 25 HP		AO	grob coarse dur grueso grossa	Braun Brown Marron Marron Marrone	
	250 25 HP.B					250 25 RED
	250 25 HP.C					250 25 UM
280	251 25 HP		SIC	mittel medium medium medio media	Grau Grey Gris Gris Grigio	
	251 25 HP.B					251 25 RED
	251 25 HP.C					251 25 UM
360	252 25 HP		AO	fein fine fin fino fine	Rot Red Rouge Rojo Rosso	
	252 25 HP.B					252 25 RED
	252 25 HP.C					252 25 UM
360	255 25 HP		AO	fein fine fin fino fine	Purpur Purple Violet Púrpura Viola	
	255 25 HP.B					255 25 RED
	255 25 HP.C					255 25 UM
400	257 25 HP		SIC	extra fein extra fine extra fin extra fino extra fine	Hellgrau Light Grey Gris clair Gris claro Grigio chiaro	
	257 25 HP.B					257 25 RED
	257 25 HP.C					257 25 UM
600	256 25 HP		AO	ultra fein ultra fine ultra fin ultra fino ultra fine	Kupfer Copper Cuivre Cobre Rame	
	256 25 HP.B					256 25 RED
	256 25 HP.C					256 25 UM
-	253 25 HP 253 25 HP.B 253 25 HP.C			ohne Schleifmittel without abrasive sans grain sin grano senza grana	Weiß White Blanc Blanco Bianca	
220	254 25 HP		AO	grob gebunden coarse unitized dur lié gruesa ligado grana grosso	Marmor Marble Marbre Mármol Marmo	
	254 25 HP.B					254 25 RED
	254 25 HP.C					254 25 UM

Schleifvliesräder mit Scotch Brite™
Trimming Wheels with Scotch Brite™
Roues d'affilage en toison abrasive avec Scotch Brite™
Muelas abrasivas Scotch Brite™
Routine abrasive in Scotch Brite™

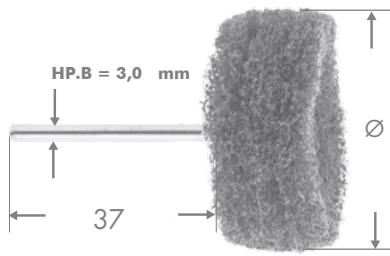

10.000

mesh

	Art.Nr. art.No.	Ø mm	Korn grit	Charakter character	Color
 <p>220</p>	250 40/3 HP.B	40	AO	grob coarse dur grueso grossa	Braun Brown Marron Marron Marrone
	250 30/3 HP.B	30			
 <p>280</p>	251 40/3 HP.B	40	SIC	mittel medium medium medio media	Grau Grey Gris Gris Grigio
	251 30/3 HP.B	30			
 <p>360</p>	451 40/3 HP.B	40	AO	mittel medium medium medio media	Rot-Braun Red Brown Rouge-marron Rojo marrón Rosso marrone
	451 30/3 HP.B	30			
 <p>360</p>	252 40/3 HP.B	40	AO	fein fine fin fino fine	Rot Red Rouge Rojo Rosso
	252 30/3 HP.B	30			
 <p>360</p>	255 40/3 HP.B	40	AO	fein fine fin fino fine	Purpur Purple Violet Púrpura Viola
	255 30/3 HP.B	30			



	240 25 R	25	AO	3 mm gepresst 3 mm pressed pressé à 3 mm 3 mm prensado pressato a 3 mm
---	----------	----	----	--





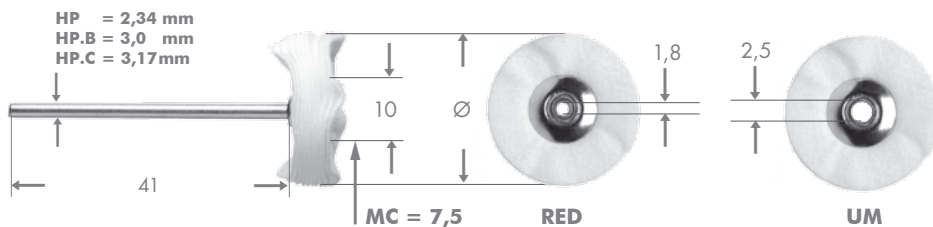

Miniaturschwabbeln
Miniature Polishing Discs
Disques miniatures à polir
Discos miniaturas de pulimento
Dischi miniatur per lucidare





Besatzmaterial
filling material
matériel de garniture
guarnición
materiale utilizzato

grober Baumwollfaden coarse cotton thread fil de coton dur hilo de algodón grueso filo di cotone grosso Ø 22 mm 10.000	 normal voll normal thickness	 normal voll normal thickness	 extra voll extra full
	150 22 HP 150 22 HRB 150 22 HRC	150 22 UM 150 22 RED	151 22 HP 151 22 HRB 151 22 HRC



feiner Baumwollfaden fine cotton thread fil de coton fin hilo de algodón fino filo di cotone fine Ø 22 mm 10.000	 normal voll normal thickness	 doppelt voll double thickness	 extra voll extra full	 doppelt extra voll double extra full
	152 22 HP 152 22 HRB 152 22 HRC	153 22 HP 153 22 HRB 153 22 HRC	154 22 HP 154 22 HRB 154 22 HRC	155 22 HP 155 22 HRB 155 22 HRC

silikonisiertes Baumwollgewebe silicon coated cotton fabric tissu de coton siliconé tejido de algodón siliconado tessuto di cotone siliconato Ø 22 mm 10.000	COSIMA Soft weich soft doux blando morbido 		COSIMA 	
	869 22 HP 869 22 HRB 869 22 HRC	869 22 UM 869 22 RED	870 22 HP 870 22 HRB 870 22 HRC	870 22 UM 870 22 RED

Baumwollgewebe verstärkt reinforced cotton fabric toile de coton et renforcé tejido de algodón reforzado tessuto di cotone rafforzato Ø 25 mm 10.000	MIRA Mini 	MIRA Mini genäht stitched cousue cosida cucito 	MIRA Mini genäht stitched cousue cosida cucito 
	867 25 HP 867 25 HRB 867 25 HRC	867 25g HP 867 25g HRB 867 25g HRC	867 25g R

Nessel Tuch muslin cloth mousseline muselina tela in mussola Ø 22 mm 10.000			Ø 16 mm 	Ø 19 mm 	Ø 22 mm 
	160 22 HP 160 22 UM	160 16 (MC) HP 160 19 (MC) HP 160 22 (MC) HP			

Besatzmaterial
filling material
matériel de garniture
guarnición
materiale utilizzato



Nesseltuch genäht muslin cloth stitched mousseline cousue muselina cosida tela cucita	Ø 22 mm 	Ø 25 mm 	Ø 28 mm
	160 22g HP 160 22g UM	160 25g HP 160 25g UM	160 28g HP

gebleichter Nesselstoff muslin cloth white disque de mousseline blanche cepillo de muselina blanqueada mussola tinta	Ø 22 mm 	Ø 25 mm
	164 22 HP 164 22 UM	164 25g HP

Microfaser microfibre microfibre microfibre microfibra	Ø 22 mm 	ZETA
	862 22 HP 862 22 HRB 862 22 HRC	862 22 UM 862 22 RED

Wildleder chamois leather peau de chamois cuero de gamuza pelle di camoscio	Ø 22 mm 	Ø 25 mm 	
	500 22 HP 500 22 HRB 500 22 HRC	500 22 UM 500 22 RED	500 25 HP 500 25 HRB 500 25 HRC

Mikrofaser-Leder microfibre leather cuir synthétique cuero de microfibra pelle in microfibra	Ø 22 mm 	
	520 22 HP 520 22 HRB 520 22 HRC	520 22 UM 520 22 RED

Flanell flannell cloth flannelle franela flanella	Ø 22 mm 	
	161 22 HP 161 22 HRB 161 22 HRC	161 22 UM 161 22 RED

Filztuch felt cloth toile de feutre tela de fieltro feltro	Ø 22 mm 	Ø 25 mm 	
	162 22 HP 162 22 HRB 162 22 HRC	162 22 UM 162 22 RED	162 25 HP 162 25 HRB 162 25 HRC



Filzpolierkörper
Felt polishers
Feutres
Filtros para pulir
Feltri per lucidare

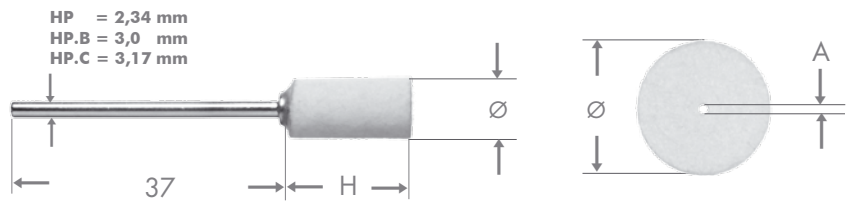

D= Dichte Density Densité
 Densidad Densitá

	Art.Nr. art.No.	Ø mm	H mm	A mm	D	
	173 15x20	15	20	4,2	hart hard dur duro duro	
	173 15x25	15	25			
	173 15x30	15	30	5,0		
	173 20x35	20	35			
	173 20x40	20	40			
	173 25x45	25	45	5,5		
	173 20x50	20	50			
	173 25x50	25	50			
173 30x60	30	60				
	174 12x3 036	12	3	1,8	weich/soft standard/standard extra weich/extra soft extra weich/extra soft standard/standard hart/hard weich/soft	
	174 21x4 056	21	4			
	174 25x4 028	25	4			
	174 25x5 028	25	5			
	174 25x5 056	25	5			
	174 25x5 065	25	5			
	174 25x6 030	25	6	3,0		
	174 25x8 056	25	8			
	174 30x10	30	10			
	174 40x10	40	10			
	174 50x10	50	10			
	174 60x13	60	13			
	174 80x20	80	20			
	174 80x25	80	25			
174 100x20	100	20				
	174 17 UM	17	4	2,5	weich soft doux blando morbido	
	174 19 UM	19	4			
	174 21 UM	21	4			
	174 25 UM	25	4			
	174 17 RED	17	4	1,8		
	174 19 RED	19	4			
	174 21 RED	21	4			
	175 12x3	12	3	1,8		hart hard dur duro duro
	175 17x4	17	4			
	175 19x4,5	19	4,5			
	175 21x5	21	5			
	175 25x7	25	7			
	175 30x7	30	7			
	175 40x10	40	10			
	175 50x10	50	10			
175 60x13	60	13				
	176 22x13 LL	22	13		standard standard standard estándar standard	
	176 25x16 ML	25	16			
	176 22x13 LS	22	13			
	176 25x16 MS	25	16			





10.000

	Art.Nr. art.No.	Ø mm	H mm	D
	170 8 HP.B	8	14	extra hart extra hard extra dur extra duro extra duro
	170 8 HP	8	14	
	170 11 HP	11	16	
	171 10 HP	10	13	
	171 10 HP.B	10	13	
	171 12 HP	12	14	
	171 12 HP.B	12	14	
	172 4 HP	4	11	
	172 4 HP.B	4	11	
	172 6 HP	6	16	
	172 6 HP.B	6	16	
	172 8 HP	8	16	
	172 8 HP.B	8	16	
	172 10 HP	10	16	
	172 10 HP.B	10	16	
	172 12 HP	12	16	
	172 12 HP.B	12	16	
172 12 HP.C	12	16		
	173 6 HP	6	20	
	173 6 HP.B	6	20	
	173 8 HP	8	20	
	173 8 HP.B	8	20	
	173 9 HP	9	20	
	173 9 HP.B	9	20	
	173 11 HP	11	24	
	173 11 HP.B	11	24	
	174 17 HP.B	17	4	
	174 17 HP	17	4	
	174 19 HP	19	4	
	174 21 HP	21	4	
	174 21 HP.B	21	4	
	174 25 HP	25	4	
	174 25 HP.C	25	4	
	174 21x9 HP	21	10	
	174 25x10 HP	25	10	
	174 FL 20x10x1 HP	20	10	
	174 FL 20x10x1 HP.B	20	10	
	174 FL 20x10x1 HP.C	20	10	
174 FL 30x20x4 HP	30	20		
174 FL 30x20x4 HP.B	30	20		
174 FL 30x20x4 HP.C	30	20		
	175 17 HP	17	5	
	175 17 HP.B	17	5	
	175 19 HP	19	5	
	175 19 HP.B	19	5	
	175 21 HP	21	5	
	175 21 HP.B	21	5	
	176 17 HP	17	5	
	176 19 HP	19	5	
	176 19 HP.B	19	5	
	176 21 HP	21	5	
	177 7x10 HP	10	16	
	177 7x10 HP.B	10	16	
	177 12x7 HP	12	16	
	177 12x7 HP.B	12	16	





HATHOfex S plus P HATHOfex S plus P

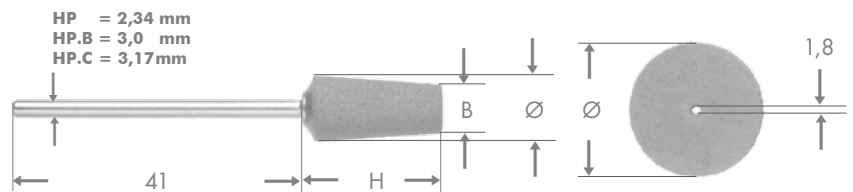
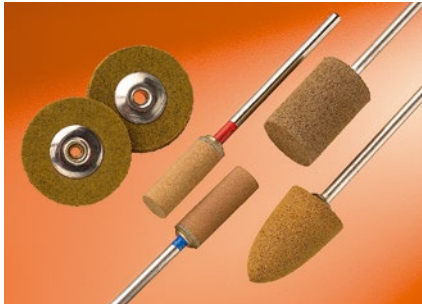

Schleif- und Polierwerkzeuge aus elastisch gebundenem Korund
Grinding and Polishing Instruments with elastic bonded corundum
Meule à affiler et à polir avec corindon, lien élastique
Herramientas de pulido de corindón elástico prensado
Abrasivi e strumenti per lucidare in lega di corindone





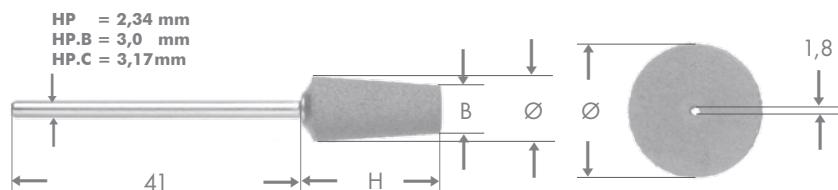





1:1

Form shape	Körnung grit	80	180	240	400	∅ mm	H mm	
 12.000	 12.000	204 20 R	214 20 R	224 20 R	234 20 R	20	3	
		204 20 UM	214 20 UM	224 20 UM	234 20 UM	20	3	
 15.000	 15.000	204 20 HP	214 20 HP	224 20 HP	234 20 HP	20	3	
		204 20 HPB	214 20 HPB	224 20 HPB	234 20 HPB			
		204 20 HRC	214 20 HRC	224 20 HRC	234 20 HRC			
 20.000	 20.000	202 6 HP	212 6 HP	222 6 HP	232 6 HP	6	16	
		202 6 HPB	212 6 HPB	222 6 HPB	232 6 HPB			
		202 6 HRC	212 6 HRC	222 6 HRC	232 6 HRC			
 15.000	 15.000	202 8 HP	212 8 HP	222 8 HP	232 8 HP	8	16	
		202 8 HPB	212 8 HPB	222 8 HPB	232 8 HPB			
		202 8 HRC	212 8 HRC	222 8 HRC	232 8 HRC			



1:1



Form shape	Körnung grit	80	180	240	400	Ø mm	H mm
 5.000		202 12 HRB	212 12 HRB	222 12 HRB	232 12 HRB	12	18
		202 12 HRC	212 12 HRC	222 12 HRC	232 12 HRC		
 20.000		200 6 HP	210 6 HP	220 6 HP	230 6 HP	6	16
		200 6 HRB	210 6 HRB	220 6 HRB	230 6 HRB		
		200 6 HRC	210 6 HRC	220 6 HRC	230 6 HRC		
 15.000		205 17 HP	215 17 HP	225 17 HP	235 17 HP	17	2,5
		205 17 HRB	215 17 HRB	225 17 HRB	235 17 HRB		
		205 17 HRC	215 17 HRC	225 17 HRC	235 17 HRC		
 12.000		206 8 HP	216 8 HP	226 8 HP	236 8 HP	8 B=6	16
		206 8 HRB	216 8 HRB	226 8 HRB	236 8 HRB		
		206 8 HRC	216 8 HRC	226 8 HRC	236 8 HRC		
 5.000		203 12 HRB	213 12 HRB	223 12 HRB	233 12 HRB	12	20
		203 12 HRC	213 12 HRC	223 12 HRC	233 12 HRC		





Minibestbürsten
Minibest Brushes
Brosses Minibest
Cepillos Minibest
Spazzole Minibest

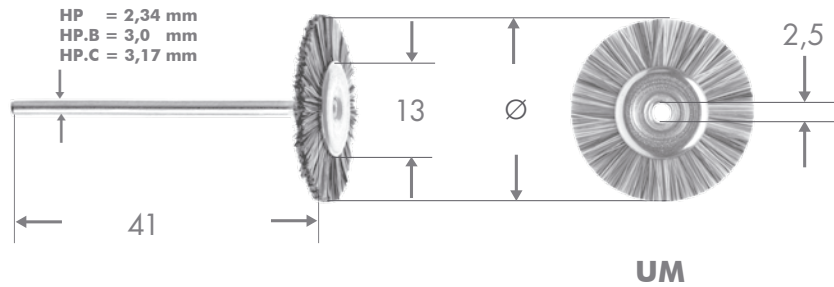

Besatzmaterial
 filling material
 matériel de garniture
 guarnición
 materiale utilizzato

10.000



	Ø	HP	HP.B	HP.C		UM
weißes Ziegenhaar · white goat hair · poils de chèvre blancs · pelo de cabra blanco · pelo di capra bianco						
	23	100 23 HP	100 23 HP.B	100 23 HP.C		100 23 UM
	25	100 25 HP	100 25 HP.B	100 25 HP.C		100 25 UM
	28	100 28 HP	100 28 HP.B	100 28 HP.C		100 28 UM
	32	100 32 HP	100 32 HP.B	100 32 HP.C		100 32 UM
graues Ziegenhaar · grey goat hair · poils de chèvre gris · pelo de cabra gris · pelo di capra grigio						
	23	102 23 HP	102 23 HP.B	102 23 HP.C		102 23 UM
	25	102 25 HP	102 25 HP.B	102 25 HP.C		102 25 UM
	28	102 28 HP	102 28 HP.B	102 28 HP.C		102 28 UM
	32	102 32 HP	102 32 HP.B	102 32 HP.C		102 32 UM
graues Pferdehaar weich · grey horse hair soft · crins de cheval gris doux · crin de caballo gris blando · crine di cavallo grigio morbido						
	23	112 23 HP	112 23 HP.B	112 23 HP.C		112 23 UM
	25	112 25 HP	112 25 HP.B	112 25 HP.C		112 25 UM
	28	112 28 HP	112 28 HP.B	112 28 HP.C		112 28 UM
	32	112 32 HP	112 32 HP.B	112 32 HP.C		112 32 UM
silbergraues Pferdehaar standart hart · silvergrey horse hair standart hard · crins de cheval gris argent standart dur						
	23	115 23 HP	115 23 HP.B	115 23 HP.C		115 23 UM
	25	115 25 HP	115 25 HP.B	115 25 HP.C		115 25 UM
	28	115 28 HP	115 28 HP.B	115 28 HP.C		115 28 UM
	32	115 32 HP	115 32 HP.B	115 32 HP.C		115 32 UM
weiße Chungking Borsten · white chungking bristles · soie de Tchong King blanche · cerda de Chung King blanca · setola di Chungking bianca						
	23	120 23 HP	120 23 HP.B	120 23 HP.C		120 23 UM
	25	120 25 HP	120 25 HP.B	120 25 HP.C		120 25 UM
	28	120 28 HP	120 28 HP.B	120 28 HP.C		120 28 UM
	32	120 32 HP	120 32 HP.B	120 32 HP.C		120 32 UM

Besatzmaterial
filling material
matériel de garniture
guarnición
materiale utilizzato

10.000

	Ø	HP	HP.B	HP.C		UM
schwarze Chungking Borsten · black Chungking bristles · soie de Tchong King noire · cerda de Chung King negra · setola di Chungking nera						
	23	121 23 HP	121 23 HP.B	121 23 HP.C		121 23 UM
	25	121 25 HP	121 25 HP.B	121 25 HP.C		121 25 UM
	28	121 28 HP	121 28 HP.B	121 28 HP.C		121 28 UM
	32	121 32 HP	121 32 HP.B	121 32 HP.C		121 32 UM
gewellter Messingdraht · crimped brass wire · fil de laiton ondulé · alambre de latón ondulado · filo di ottone ondulado						
 <p>Ø 0,10</p>	23	143 23 HP	143 23 HP.B	143 23 HP.C		143 23 UM
	25	143 25 HP	143 25 HP.B	143 25 HP.C		143 25 UM
	28	143 28 HP	143 28 HP.B	143 28 HP.C		143 28 UM
	32	143 32 HP	143 32 HP.B	143 32 HP.C		143 32 UM
gewellter Edelstahlraht · crimped stainless steel wire · fil d'acier inoxydable ondulé · alambre de acero inoxidable ondulado · filo d'acciaio inossidabile ondulado						
 <p>Ø 0,10</p>	23	183 23 HP	183 23 HP.B	183 23 HP.C		183 23 UM
	25	183 25 HP	183 25 HP.B	183 25 HP.C		183 25 UM
	28	183 28 HP	183 28 HP.B	183 28 HP.C		183 28 UM
	32	183 32 HP	183 32 HP.B	183 32 HP.C		183 32 UM
gewellter Stahldraht · crimped steel wire · fil d'acier ondulé · alambre de acero ondulado · filo d'acciaio ondulado						
 <p>Ø 0,10</p>	23	193 23 HP	193 23 HP.B	193 23 HP.C		193 23 UM
	25	193 25 HP	193 25 HP.B	193 25 HP.C		193 25 UM
	28	193 28 HP	193 28 HP.B	193 28 HP.C		193 28 UM
	32	193 32 HP	193 32 HP.B	193 32 HP.C		193 32 UM
Nylonfaser · nylon fibre · fibres de nylon · fibra de nylon · fibra di nylon						
 <p>Ø 0,30</p>	23	286 23 HP	286 23 HP.B	286 23 HP.C		286 23 UM
	25	286 25 HP	286 25 HP.B	286 25 HP.C		286 25 UM
	28	286 28 HP	286 28 HP.B	286 28 HP.C		286 28 UM
	32	286 32 HP	286 32 HP.B	286 32 HP.C		286 32 UM
HABRAS Bürsten AO 600 · HABRAS Brush AO 600 · Brosses HABRAS AO 600 · Cepillos HABRAS AO 600 · Spazzole HABRAS AO 600						
 <p>Ø 0,30</p>	23	400 23 HP	400 23 HP.B	400 23 HP.C		400 23 UM
	25	400 25 HP	400 25 HP.B	400 25 HP.C		400 25 UM
	28	400 28 HP	400 28 HP.B	400 28 HP.C		400 28 UM
	32	400 32 HP	400 32 HP.B	400 32 HP.C		400 32 UM





Miniaturkelche, Miniaturpinsel (Endbürsten)
Miniature Brushes cup shaped, End Brushes
Brosses miniatures en forme de coupe, Mini pinceaux
Cepillos miniaturas en forma de copa, pinceles
Spazzole miniatura coppetta, pennelli

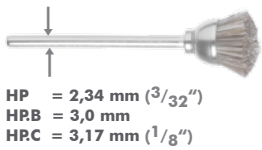
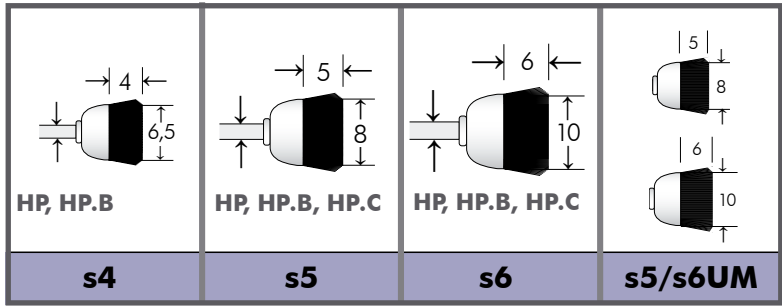

montiert = Schaft
mounted = shank
tige
vástago
gambo

UM = unmontiert
unmounted
non montée
no montado
non montato

Besatzmaterial
filling material
matériel de garniture
guarnición
materiale utilizzato

















10.000



	s4	s5	s6	UM
weißes Ziegenhaar white goat hair poils de chèvre blancs pelo de cabra blanco pelo di capra bianco				
	100 s4 HP 100 s4 HP.B	100 s5 HP 100 s5 HP.B 100 s5 HP.C	100 s6 HP 100 s6 HP.B 100 s6 HP.C	100 s5 UM 100 s6 UM
graves Ziegenhaar grey goat hair poils de chèvre gris pelo de cabra gris pelo di capra grigio				
		102 s5 HP 102 s5 HP.B 102 s5 HP.C	102 s6 HP 102 s6 HP.B 102 s6 HP.C	102 s5 UM 102 s6 UM
graves Pferdehaar grey horse hair crins de cheval gris crin de caballo gris crine di cavallo grigio				
		112 s5 HP 112 s5 HP.B 112 s5 HP.C	112 s6 HP 112 s6 HP.B 112 s6 HP.C	112 s5 UM 112 s6 UM
silbergraves Pferdehaar hart silvergrey horse hair hard crins de cheval gris argent dur crin de caballo gris argentado duro crine di cavallo grigio argen- tato duro				
		115 s5 HP 115 s5 HP.B 115 s5 HP.C	115 s6 HP 115 s6 HP.B 115 s6 HP.C	115 s6 UM
weiße Chungking Borsten white Chungking bristles soie de Tchong King blanche cerda de Chung King blanca setola di Chungking bianca				
	120 s4 HP 120 s4 HP.B	120 s5 HP 120 s5 HP.B 120 s5 HP.C	120 s6 HP 120 s6 HP.B 120 s6 HP.C	120 s5 UM 120 s6 UM
schwarze Chungking Borsten black Chungking bristles soie de Tchong King noire cerda de Chung King negra setola di Chungking nera				
	121 s4 HP 121 s4 HP.B	121 s5 HP 121 s5 HP.B 121 s5 HP.C	121 s6 HP 121 s6 HP.B 121 s6 HP.C	121 s5 UM 121 s6 UM

Besatzmaterial
filling material
matériel de garniture
guarnición
materiale utilizzato

10.000

	s4	s5	s6	UM					
gewellter Messingdraht crimped brass wire fil de laiton ondulé alambre de latón ondulado filo di ottone ondolato									
					Ø 0,06 mm	141 s5 HP	141 s6 HP	141 s5 UM	
							141 s6 HP.B	141 s6 UM	
					Ø 0,08 mm	142 s4 HP	142 s5 HP	142 s6 HP	
						142 s4 HP.B	142 s5 HP.B	142 s6 HP.B	
								142 s6 HP.C	
Ø 0,10 mm	143 s4 HP	143 s5 HP	143 s6 HP						
	143 s4 HP.B	143 s5 HP.B	143 s6 HP.B	143 s5 UM					
		143 s5 HP.C	143 s6 HP.C	143 s6 UM					
Ø 0,12 mm		144 s5 HP	144 s6 HP	144 s5 UM					
			144 s6 HP.B	144 s6 UM					
			144 s6 HP.C						
Ø 0,15 mm			145 s6 HP						
			145 s6 HP.B						
gewellter Edelstahlraht crimped stainless steel wire fil d'acier inoxydable ondulé alambre de acero inoxidable ondulado filo d'acciaio inossidabile ondulato									
					Ø 0,06 mm	181 s5 HP	181 s6 HP	181 s5 UM	
								181 s6 UM	
					Ø 0,08 mm		182 s5 HP	182 s6 HP	
								182 s6 HP.B	182 s5 UM
								182 s6 HP.C	182 s6 UM
Ø 0,10 mm		183 s5 HP	183 s6 HP						
		183 s5 HP.B	183 s6 HP.B	183 s5 UM					
			183 s6 HP.C	183 s6 UM					
Ø 0,12 mm		184 s5 HP	184 s6 HP	184 s5 UM					
			184 s6 HP.B	184 s6 UM					
			184 s6 HP.C						
gewellter Stahldraht crimped steel wire fil d'acier ondulé alambre de acero ondulado filo d'acciaio ondulato									
					Ø 0,08 mm	192 s5 HP	192 s6 HP		
						192 s5 HP.B	192 s6 HP.B	192 s5 UM	
							192 s6 HP.C	192 s6 UM	
					Ø 0,10 mm		193 s5 HP	193 s6 HP	
							193 s5 HP.B	193 s6 HP.B	193 s5 UM
			193 s6 HP.C	193 s6 UM					
Ø 0,12 mm		194 s5 HP	194 s6 HP	194 s5 UM					
			194 s6 HP.B	194 s6 UM					
			194 s6 HP.C						
Ø 0,15 mm			195 s6 HP						
Nylonfaser, transparent Nylon filament, transparent fibres de nylon, transparent fibra de nylon, trasparente fibra di nylon, trasparente									
					Ø 0,15 mm	282 s4 HP	282 s5 HP	282 s6 HP	282 s5 UM
						282 s4 HP.B	282 s5 HP.B	282 s6 HP.B	282 s6 UM
								282 s6 HP.C	
					Ø 0,20 mm			283 s6 HP	
			283 s6 HP.B	283 s6 UM					
			283 s6 HP.C						
Ø 0,30 mm			286 s6 HP	286 s6 UM					





Miniaturlkelche, Miniaturpinsel (Endbürsten)
Miniature Brushes cup shaped, End Brushes
Brosses miniatures en forme de coupe, Mini pinceaux
Cepillos miniaturas en forma de copa, pinceles
Spazzole miniatura coppetta, pennelli

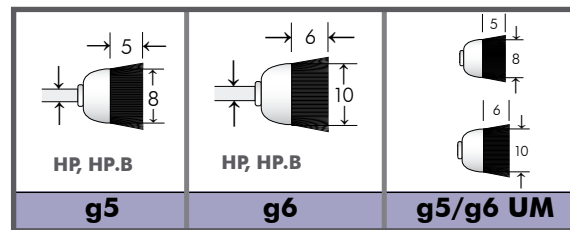

g = gerade geschnitten
straight cut
coup droite
corte recto
taglio dell ritto

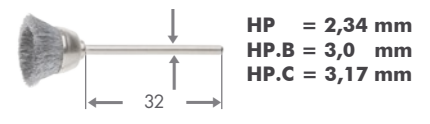

Besatzmaterial
filling material
matériel de garniture
guarnición
materiale utilizzato

5.000



	g5	g6	UM
weißes Ziegenhaar white goat hair poils de chèvre blancs pelo de cabra blanco pelo di capra bianco	 100 g5 HP 100 g5 HP.B	 100 g6 HP 100 g6 HP.B	
weiße Chungking Borsten white Chungking bristles soie de Tchong King blanche cerda de Chung King blanca setola di Chungking bianca	 120 g5 HP 120 g5 HP.B	 120 g6 HP 120 g6 HP.B	 120 g6 UM
schwarze Chungking Borsten black Chungking bristles soie de Tchong King noire cerda de Chung King negra setola di Chungking nera		 121 g6 HP 121 g6 HP.B	
gewellter Messingdraht crimped brass wire fil de laiton ondulé alambre de latón ondulado filo di ottone ondulado	 Ø 0,06 mm Ø 0,08 mm Ø 0,10 mm Ø 0,12 mm	 141 g6 HP 142 g6 HP 143 g6 HP 143 g6 HP.B 144 g6 HP	
gewellter Edelstahlraht crimped stainless steel wire fil d'acier inoxydable ondulé alambre de acero inoxidable ondulado filo d'acciaio inossidabile ondulado	Ø 0,08 mm Ø 0,10 mm	 182 g6 HP 183 g6 HP	
gewellter Stahldraht crimped steel wire fil d'acier ondulé alambre de acero ondulado filo d'acciaio ondulado	Ø 0,08 mm Ø 0,10 mm	 192 g6 HP 192 g6 HP.B 193 g6 HP	
Nylonfaser, schwarz Nylon filament, black fibres de nylon, noir fibra de nylon, negra fibra di nylon, nero	Ø 0,30 mm	 267 g6 HP	 267 g6 UM
Nylonfaser, transparent Nylon filament, transparent fibres de nylon, transparent fibra de nylon, trasparente fibra di nylon, trasparente	Ø 0,15 mm Ø 0,20 mm Ø 0,30 mm	 282 g6 HP 283 g6 HP 286 g6 HP	 282 g6 UM 283 g6 UM

Miniaturpinsel (Endbürsten)
Miniature End Brushes
Brosses miniature en forme de pinceau
Cepillos en forma de pincel
Spazzole a pennellino



p6 UM*	p6 UML*	p7	p8	p9	p10	p11	p12	p13

5.000

Besatzmaterial
 filling material
 matériel de garniture
 guarnición
 materiale utilizzato

*** nur zu verwenden mit SP 3 HP (Seite 66)**
 use only with SP 3 HP
 utiliser uniquement avec SP 3 HP
 emplear solo con SP 3 HP
 utilizzare solo con SP 3 HP



weißes Ziegenhaar · white goat hair · poils de chèvre blancs · pelo de cabra blanco · pelo di capra bianco

100 p6 UM	100 p6 UML	100 p7 HP 100 p7 HP.B 100 p7 HP.C	100 p8 HP 100 p8 HP.B 100 e8 HP.C	100 p9 HP 100 p9 HP.B 100 p9 HP.C	100 p10 HP 100 p10 HP.B 100 p10 HP.C	100 p11 HP 100 p11 HP.B 100 p11 HP.C	100 p12 HP 100 p12 HP.B 100 p12 HP.C	100 p13 HP 100 p13 HP.B 100 p13 HP.C

weiße Chungking Borsten · white chungking bristles · soie de Tchong King blanche · cerda de Chung King blanca · setola di Chungking bianca

120 p6 UM	120 p6 UML	120 p7 HP 120 p7 HP.B 120 p7 HP.C	120 p8 HP 120 p8 HP.B 120 e8 HP.C	120 p9 HP 120 p9 HP.B 120 p9 HP.C	120 p10 HP 120 p10 HP.B 120 p10 HP.C	120 p11 HP 120 p11 HP.B 120 p11 HP.C	120 p12 HP 120 p12 HP.B 120 p12 HP.C	120 p13 HP 120 p13 HP.B 120 p13 HP.C

schwarze Chungking Borsten · black Chungking bristles · soie de Tchong King noire · cerda de Chung King negra · setola di Chungking nera

121 p6 UM	121 p6 UML	121 p7 HP 121 p7 HP.B 121 p7 HP.C	121 p8 HP 121 p8 HP.B 121 e8 HP.C	121 p9 HP 121 p9 HP.B 121 p9 HP.C	121 p10 HP 121 p10 HP.B 121 p10 HP.C	121 p11 HP 121 p11 HP.B 121 p11 HP.C	121 p12 HP 121 p12 HP.B 121 p12 HP.C	121 p13 HP 121 p13 HP.B 121 p13 HP.C

Nylonfaser transparent · nylon fibre, transparent · fibres de nylon, transparent · fibra de nylon, trasparente · fibra di nylon, trasparente

282 p6 UM	282 p6 UML	282 p7 HP 282 p7 HP.B 282 p7 HP.C	282 p8 HP 282 p8 HP.B 282 e8 HP.C	282 p9 HP 282 p9 HP.B 282 p9 HP.C	282 p10 HP 282 p10 HP.B 282 p10 HP.C	282 p11 HP 282 p11 HP.B 282 p11 HP.C		

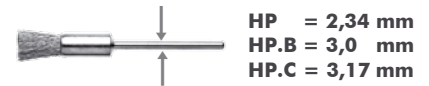

p6 UM*	p6 UML*	p7	p8	p9	p10	p11	p12	p13

Besatzmaterial
filling material
matériel de garniture
guarnición
materiale utilizzato

* nur zu verwenden mit SP 3 HP (Seite 66)
use only with SP 3 HP
utiliser uniquement avec SP 3 HP
emplear solo con SP 3 HP
utilizzare solo con SP 3 HP

5.000



gewellter Messingdraht · crimped brass wire · fil de laiton ondulé · alambre de latón ondulado · filo di ottone ondolato

Ø 0,06 mm		141 p7 HP 141 p7 HP.B 141 p7 HP.C	141 p8 HP 141 p8 HP.B 141 e8 HP.C		141 p10 HP			
Ø 0,08 mm								
142 p6 UM	142 p6 UML	142 p7 HP 142 p7 HP.B 142 p7 HP.C	142 p8 HP 142 p8 HP.B 142 e8 HP.C			142 p11 HP 142 p11 HP.B 142 p11 HP.C		
Ø 0,10 mm								
143 p6 UM	143 p6 UML	143 p7 HP 143 p7 HP.B 143 p7 HP.C	143 p8 HP 143 p8 HP.B	143 p9 HP	143 p10 HP 143 p10 HP.B	143 p11 HP	143 p12 HP 143 p12 HP.B	143 p13 HP 143 p13 HP.B 143 p13 HP.C
Ø 0,12 mm								
		144 p7 HP 144 p7 HP.B 144 p7 HP.C	144 p8 HP 144 p8 HP.B 144 e8 HP.C		144 p10 HP 144 p10 HP.B 144 p10 HP.C	144 p11 HP 144 p11 HP.B 144 p11 HP.C		

gewellter Edelstahlbraht · crimped stainless steel wire · fil d'acier inoxydable ondulé · alambre de acero inoxidable ondulado · filo d'acciaio inossidabile ondolato

Ø 0,06 mm		181 p7 UM	181 p7 UML	181 p7 HP 181 p7 HP.B 181 p7 HP.C	181 p8 HP 181 p8 HP.B 181 e8 HP.C			
Ø 0,08 mm								
182 p6 UM	182 p6 UML	182 p7 HP 182 p7 HP.B 182 p7 HP.C	182 p8 HP 182 p8 HP.B 182 e8 HP.C			182 p11 HP 182 p11 HP.B 182 p11 HP.C		
Ø 0,10 mm								
183 p6 UM	183 p6 UML	183 p7 HP 183 p7 HP.B 183 p7 HP.C	183 p8 HP 183 p8 HP.B 183 e8 HP.C	183 p9 HP	183 p10 HP 183 p10 HP.B 183 p10 HP.C	183 p11 HP	183 p12 HP 183 p12 HP.B 183 p12 HP.C	183 p13 HP 183 p13 HP.B 183 p13 HP.C
Ø 0,12 mm								
		184 p7 HP 184 p7 HP.B 184 p7 HP.C	184 p8 HP 184 p8 HP.B 184 e8 HP.C		184 p10 HP 184 p10 HP.B 184 p10 HP.C	184 p11 HP 184 p11 HP.B 184 p11 HP.C		



p6 UM*	p6 UML*	p7	p8	p9	p10	p11	p12	p13

Besatzmaterial
filling material
matériel de garniture
guarnición
materiale utilizzato

* nur zu verwenden mit SP 3 HP (Seite 66)
Use only with SP 3 HP
utiliser uniquement avec SP 3 HP
emplear solo con SP 3 HP
utilizzare solo con SP 3 HP

5.000



gewellter Stahldraht · crimped steel wire · fil d'acier ondulé · alambre de acero ondulado · filo d'acciaio ondulato

192 p6 UM	192 p6 UML	192 p7 HP 192 p7 HP.B 192 p7 HP.C	192 p8 HP 192 p8 HP.B 192 e8 HP.C			192 p11 HP 192 p11 HP.B 192 p11 HP.C		
Ø 0,10 mm								
193 p6 UM	193 p6 UML	193 p7 HP 193 p7 HP.B 193 p7 HP.C	193 p8 HP 193 p8 HP.B 193 e8 HP.C	193 p9 HP	193 p10 HP 193 p10 HP.B 193 p10 HP.C	193 p11 HP	193 p12 HP 193 p12 HP.B 193 p12 HP.C	193 p13 HP 193 p13 HP.B 193 p13 HP.C
Ø 0,12 mm								
	194 p6 UML	194 p7 HP 194 p7 HP.B 194 p7 HP.C	194 p8 HP 194 p8 HP.B 194 e8 HP.C	194 p9 HP	194 p10 HP 194 p10 HP.B 194 p10 HP.C	194 p11 HP 194 p11 HP.B 194 p11 HP.C		

Baumwolle · fine cotton thread · fil de coton fin
hilo de algodón fino · filo di cotone fine



Endbürsten mit Elastik Schutz · end brushes with elastic protective cover · pinceaux avec protection de caoutchouc · pinceles con protección de goma · pennello con protezione elastica

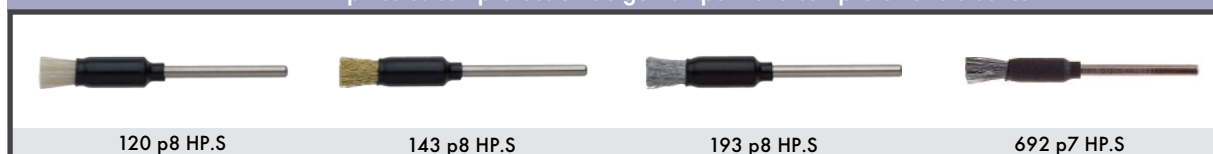



Picobürsten
Pico Brushes
Brossettes Pico
Cepillos Pico
Spazzole Pico

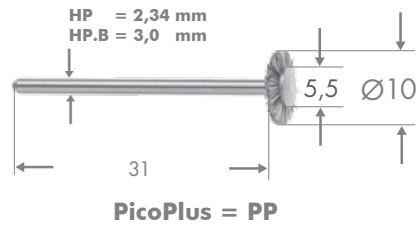

Besatzmaterial
filling material
matériel de garniture
guarnición
materiale utilizzato

	Ø 10 mm	PP
weißes Ziegenhaar white goat hair poils de chèvre blanc pelo de cabra blanca pelo di capra bianco ↳ 20.000		100 10 PP 100 10 PP.B
graues Ziegenhaar grey goat hair poils de chèvre gris pelo de cabra gris pelo di capra grigio ↳ 20.000		102 10 PP 102 10 PP.B
graues Pferdehaar grey horse hair crins de cheval gris crin de caballo gris crine di cavallo grigio ↳ 20.000		112 10 PP 112 10 PP.B
silbergraues Pferdehaar silyergrey horse hair crins de cheval gris argent crin de caballo gris argentado crine di cavallo grigio argentato ↳ 20.000		115 10 PP 115 10 PP.B
weiße Chungking Borsten white Chungking bristles soie de Tchong King blanche cerda de Chung King blanca setola di Chungking bianca ↳ 20.000		120 10 PP 120 10 PP.B
schwarze Chungking Borsten black Chungking bristles soie de Tchong King noire cerda de Chung King negra setola di Chungking nera ↳ 20.000		121 10 PP 121 10 PP.B
Baumwolle cotton thread fil de coton hilo de algodón filo di cotone ↳ 10.000		150 10 PP 150 10 PP.B
gewellter Messingdraht Ø 0,08 mm crimped brass wire fil de laiton ondulé gambre de latón ondulado filo di ottone ondulato ↳ 10.000		142 10 PP 142 10 PP.B
gewellter Edelstahlraht Ø 0,08 mm crimped stainless steel wire fil d'acier inoxydable ondulé gambre de acero inoxidable ondulado filo d'acciaio inossidabile ondulato ↳ 10.000		182 10 PP 182 10 PP.B
gewellter Stahldraht Ø 0,08 mm crimped steel wire fil d'acier ondulé gambre de acero ondulado filo d'acciaio ondulato ↳ 10.000		192 10 PP 192 10 PP.B
Scotch Brite™ grob Scotch Brite™ coarse Scotch Brite™ dur Scotch Brite™ grueso Scotch Brite™ grosso ↳ 10.000		250 10 PP 250 10 PP.B



Microbürsten
Micro Brushes
Brossettes Micro
Cepillos Micro
Spazzole Micro

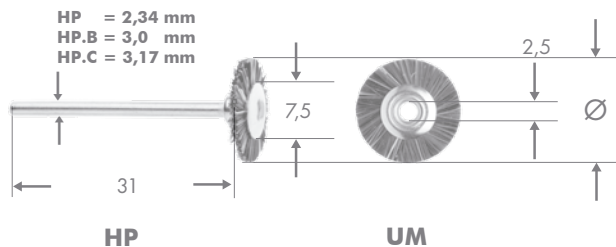

Besatzmaterial
 filling material
 matériel de garniture
 guarnición
 materiale utilizzato



	Ø 12 mm		Ø 14 mm	
weißes Ziegenhaar white goat hair poils de chèvre blanc pelo de cabra blanca pelo di capra bianco 15.000				
	100 12 HP	100 12 UM	100 14 HP	100 14 UM
graues Pferdehaar grey horse hair crins de cheval gris crin de caballo gris crine di cavallo grigio 15.000				
	112 12 HP	112 12 UM	112 14 HP	112 14 UM
silbergraues Pferdehaar silvergrey horse hair crins de cheval gris argent crin de caballo gris argentado crine di cavallo grigio argentato 15.000				
	115 12 HP	115 12 UM	115 14 HP	115 14 UM
weiße Chungking Borsten white Chungking bristles soie de Tchong King blanche cerda de Chung King blanca setola di Chungking bianca 15.000				
	120 12 HP 120 12 HRB	120 12 UM	120 14 HP 120 14 HRB	120 14 UM
schwarze Chungking Borsten black Chungking bristles soie de Tchong King noire cerda de Chung King negra setola di Chungking nera 15.000				
	121 12 HP 121 12 HRB	121 12 UM	121 14 HP 121 14 HRB 121 14 HRC	121 14 UM
gewellter Messingdraht crimped brass wire fil de laiton ondulé alambre de latón ondulado filo di ottone ondulato 10.000				
Ø 0,06 mm	141 12 HP 141 12 HRB	141 12 UM	141 14 HP 141 14 HRB	141 14 UM
Ø 0,08 mm	142 12 HP 142 12 HRB 142 12 HRC	142 12 UM	142 14 HP 142 14 HRB 142 14 HRC	142 14 UM
Ø 0,10 mm	143 12 HP	143 12 UM	143 14 HP	143 14 UM
Ø 0,12 mm	144 12 HP	144 12 UM	144 14 HP	144 14 UM
Baumwolle grob coarse cotton thread fil de coton dur hilo de algodón grueso filo di cotone grosso 10.000				
	150 12 HP	150 12 UM	150 14 HP 150 14 HRB	150 14 UM
Baumwolle fein fine cotton thread fil de coton fin hilo de algodón fino filo di cotone fine 10.000				
	152 12 HP	152 12 UM	152 14 HP	152 14 UM



Microbürsten
Micro Brushes
Brossettes Micro
Cepillos Micro
Spazzole Micro



















Besatzmaterial
filling material
matériel de garniture
guarnición
materiale utilizzato



	Ø 12 mm		Ø 14 mm	
Nesseltuch muslin mousseline muselina tela in mussola				
	160 12 HP	160 12 UM	160 14 HP 160 14 HRB	160 14 UM
↻ 15.000				
Flanell flannel flannelle franela flanella				
	161 12 HP	161 12 UM	161 14 HP	161 14 UM
↻ 15.000				
Filztuch felt cloth toile de feutre tela de fieltro feltro				
	162 12 HP	162 12 UM	162 14 HP 162 14 HRB	162 14 UM
↻ 15.000				
gebleichter Nesselstoff bleached muslin cloth mousseline blanchie muselina blanqueada mussola tinta				
	164 12 HP	164 12 UM	164 14 HP	164 14 UM
↻ 15.000				
↻ 10.000 gewellter Edelstahldraht crimped stainless steel wire fil d'acier inoxydable ondulé alambre de acero inoxidable ondulado filo d'acciaio inossidabile ondulado				
	181 12 HP 181 12 HRB 181 12 HRC	181 12 UM	181 14 HP 181 14 HRB	181 14 UM
↻ 10.000				
Ø 0,08 mm	182 12 HP 182 12 HRB	182 12 UM	182 14 HP 182 14 HRB	182 14 UM
Ø 0,10 mm	183 12 HP 183 12 HRB	183 12 UM	183 14 HP 183 14 HRB	183 14 UM
Ø 0,12 mm	184 12 HP	184 12 UM	184 14 HP	184 14 UM

Besatzmaterial
 filling material
 matériel de garniture
 guarnición
 materiale utilizzato



	Ø 12 mm		Ø 14 mm	
<p>gewellter Stahldraht crimped steel wire fil d'acier ondulé alambre de acero ondulado filo d'acciaio ondolato</p>				
<p>Ø 0,08 mm 10.000</p>	192 12 HP	192 12 UM	192 14 HP 192 14 HRB	192 14 UM
<p>Ø 0,10 mm</p>	193 12 HP 193 12 HRB	193 12 UM	193 14 HP	193 14 UM
<p>Ø 0,12 mm</p>	194 12 HP 194 12 HRB	194 12 UM	194 14 HP	194 14 UM
<p>Wildleder chamois leather peau de chamois cuero de gamuza pelle di camoscio</p>				
<p>10.000</p>	500 12 HP	500 12 UM	500 14 HP	500 14 UM
<p>COSIMA Weiches silikoniertes Baumwollgewebe soft silicon coated cotton fabric tissu de coton doux et siliconé tejido blando de algodón siliconado tessuto di cotone siliconato morbido</p>				
	869 12 HP	869 12 UM	869 14 HP	869 14 UM
<p>COSIMA Soft Silikoniertes Baumwollgewebe silicon coated cotton fabric tissu de coton siliconé tejido de algodón siliconado tessuto di cotone siliconato</p>				
	870 12 HP	870 12 UM	870 14 HP	870 14 UM
<p>Scotch Brite™ grob Scotch Brite™ coarse Scotch Brite™ dur Scotch Brite™ grueso Scotch Brite™ grosso</p>				
<p>5.000</p>			250 14 HP	250 14 UM



Diamantierte Bürsten und Polierer, DiaDisc
Diamond Brushes and Polishers, DiaDisc
Brosses et polissoirs diamantés, DiaDisc
Cepillos y pulidores diamantados, DiaDisc
Spazzole diamantate e lucidanti, DiaDisc

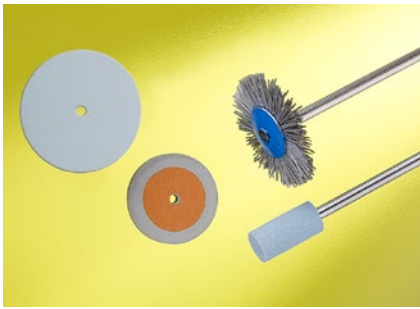

HP = 2,34 mm
 HP.B = 3,0 mm
 HP.C = 3,14 mm

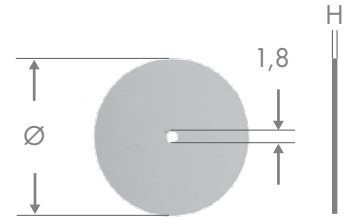





NyDiFi Bürsten
NyDiFi Brushes
Brosses NyDiFi
Cepillos NyDiFi
Spazzole NyDiFi

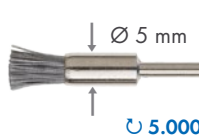

Körnung
grit



Code

		Ø 22 mm	p8	s6
		 10.000	 5.000	 10.000
Ø 0,40 400		356 22 HP 356 22 HP.B 356 22 HP.C	356 p8 HP 356 p8 HP.B 356 e8 HP.C	356 s6 HP 356 s6 HP.B 356 s6 HP.C
Ø 0,25 800		358 22 HP 358 22 HP.B 358 22 HP.C	358 p8 HP 358 p8 HP.B 358 e8 HP.C	358 s6 HP 358 s6 HP.B 358 s6 HP.C
Ø 0,25 1100		360 22 HP 360 22 HP.B 360 22 HP.C	360 p8 HP 360 p8 HP.B 360 e8 HP.C	360 s6 HP 360 s6 HP.B 360 s6 HP.C



Diamantpolierer
diamond polishers
polissoirs diamantés
pulidores diamantados
abrasivi diamantati



 10.000	Ø 16 mm	334 16 UM
 15.000	Ø 4 mm	333 4 HP
 10.000	Ø 11 mm	334 11 HP

DiaDisc
DiaDisc



10.000



Art.Nr. art.No.	Farbe Color	Korngröße grit size	Ø mm	H mm
343 22 R	Blau Blue Bleu Azul Blu	extra fein extra fine extra fin extra fino extra fine	22	0,5
346 22 R	Grün Green Vert Verde Verde	fein fine fin fino fine	22	0,5

DiaStone_Z, DiaStone_L
DiaStone_Z, DiaStone_L

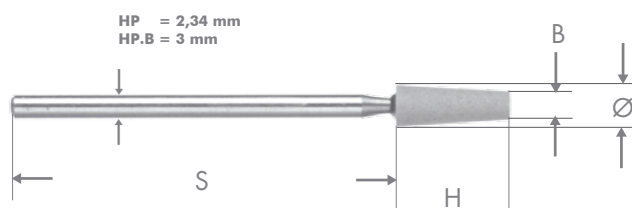

DiaStone



































	Art.Nr. art.No.	Farbe color	Anwendung application	Korngröße grit size	S mm	H mm	Ø mm	B mm
 10.000	327 4 HP	■ ■	L	extra fein, extra fine, extra fin, extra fino, extrafine 800	33	11	4	3
	367 4 HP	■	Z					2,5
	337 4 HP	■ ■	L	mittel, medium, medium, medio, media 200	33	11	4	3
	377 4 HP ⁺	■	Z					2,5
	387 4 HP	■ ■	L	grob, coarse, dur, grueso, grossa 120	33	11	4	3
	397 4 HP ⁺	■	Z					2,5
 10.000	322 4 HP	■ ■	L	extra fein, extra fine, extra fin, extra fino, extrafine 800	34	12	4	
	362 4 HP	■	Z					4,8
	332 4 HP	■ ■	L	mittel, medium, medium, medio, media 200	34	12	4	
	372 4 HP ⁺	■	Z					4,8
	382 4 HP	■ ■	L	grob, coarse, dur, grueso, grossa 120	34	12	4	
	392 4 HP	■	Z					4,8
 10.000	332 6 HP	■ ■	L	mittel, medium, medium, medio, media 200	34	12	6	
	372 6 HP ⁺	■	Z					6,5
	382 6 HP	■ ■	L	grob, coarse, dur, grueso, grossa 120	34	12	6	
	392 6 HP ⁺	■	Z					6,5
 10.000	371 5 HP	■	Z	mittel, medium, medium, medio, media 200	33		5	
 10.000	334 15 HP	■ ■	L	mittel, medium, medium, medio, media 200	40		15	3
	374 15 HP ⁺	■	Z					3,5
	334 15 R	■ ■	L					3
	374 15 R	■	Z					3,5
 10.000	335 22 HP	■ ■	L	mittel, medium, medium, medio, media 200	40		22	3
	375 22 HP	■	Z					2,2
	335 22 R	■ ■	L					3
	375 22 R	■	Z					2,2

- + HP.B lieferbar
- + HP.B deliverable
- + disponible avec tige HP.B
- + disponible con vástago de HP.B
- + disponibile con gambo di HP.B

Z empfohlen für ZrO₂-Keramik
recommended for ZrO₂ Ceramic
recommandé pour ZrO₂ céramique
recomendado para ZrO₂ cerámica
raccomandato per ZrO₂ ceramica

L empfohlen für LiSi₂, Hybridkeramik
recommended for LiSi₂, Hybrid ceramics
recommandé pour LiSi₂ céramiques hybrides
recomendado para LiSi₂ cerámica híbrida
raccomandato per LiSi₂ ceramica ibrida

Anwendung
 Application • Application
 Aplicación • Applicazione

Vorpolitur • pre-polishing • pré polissage • prepulido • prelucidatura						
Braun Brown Marron Marrón Marron	 110g Ref.No. 313176	 370g Ref.No. 313177	 1,7 kg Ref.No. 313130	CuSn Au 333	CuZn Au 583	
Lintygrau Lintygrey Lintygris Lintygris Lyntygrigio	 90g Ref.No. 313168	 280g Ref.No. 313175	 1,2 kg Ref.No. 313150	Ag 925 Au 916	Au 750 3D PMMA	
Glanzpolitur • shine polishing • poli brillant • pulido • lucidatura						
Creme Cream Creme Crema Crema	 90g Ref.No. 313200			Al Ag 925	CuZn CuSn Au 333	3D PMMA 
Weiß White Blanc Blanco Bianco	 90g Ref.No. 313162	 290g Ref.No. 313169	 1,4 kg Ref.No. 313131	CrNi Au 333	CuZn CuSn Au 583	
Hochglanzpolitur • high shine polishing • Lustrage • abrillantado • brillantatura						
Grün Green Vert Verde Verda	 90g Ref.No. 313166	 300g Ref.No. 313173	 1,4 kg Ref.No. 313132	CrNi Au 333	CuZn CuSn Au 583	
Rot Red Rouge Rojo Rosso	 100g Ref.No. 313163	 300g Ref.No. 313170	 1,1 kg Ref.No. 313114	Ag 925 Au 916	Au 750	
Blau Blue Bleu Azul Blu	 75g Ref.No. 313165	 290g Ref.No. 313172	 1,1 kg Ref.No. 313133	Ag 925 Au 916	Au 750 Pt 950	
Rosa Pink Rose Rosa Rose	 75g Ref.No. 313164	 290g Ref.No. 313171	 1,1 kg Ref.No. 313153	Au 916	Pt 950	
Beige Beige Beige Beige Beige	 85g Ref.No. 313167	 290g Ref.No. 313174	 1,2 kg Ref.No. 313134			



Polistar Polierpasten
Polistar Polishing Compounds
Pâtes à polir Polistar
Pastas de pulido Polistar
Paste per lucidare Polistar



Anwendung
 Application • Application
 Aplicación • Applicazione

Spiegelglanz • mirror finish • fini miroir • brillo especular • lucidatura a specchio				
Pro Rosa Pro Pink Pro Rose Pro Rosa Pro Rose		150g Ref.No. 313196	Al CuZn CuSn Au 333 3D PMMA	
Pro Orange Pro Orange Pro Orange Pro Naranja Pro Arancio		150g Ref.No. 313188	Au 583 Au 750 Au 916	
Pro Blau Pro Blue Pro Bleu Pro Azul Pro Blu		150g Ref.No. 313197	CrNi Ag 925 Pt 950	

Spiegelglanz • mirror finish • fini miroir • brillo especular • lucidatura a specchio				
Diamant Diamond Diamant Diamante Diamante	3µm 1,5g Ref.No. 313085	3µm 4g Ref.No. 313081	Pro Diamant 2µm 12g Ref.No. 313214	CrNi Pt 950 ZrO ₂

Finale Politur • final polishing • pollissage finale • polido finale • pulido finale				
Emulsion Emulsion Emulsion Emulsión Emulsione	 50 ml Ref.No. 313148	 125 ml Ref.No. 313139	Al CuZn CuSn Ag 925 Au 333 Au 583 Au 750 Au 916 Pt 950	

Dental Dental Dentaire Dental Dentale

Kunststoff acrylic résine resines resina	Thermoplast thermoplastic thermoplastique thermoplastico	Komposit composite composite composito	Modellguss frame work armature armadura Scheletrati	Edelmetall precious précieux precioso preziosi	NEM non-precious non-précieux non-precioso non-preziosi	Keramik ceramic céramique ceramico ceramica	Titan titanium titane titanio titano	Zirkon/LiSi ₂ zirconium zircon zircón zircono

Polistar-Muster-Kit
 Polistar-Sample-Kit



Schmuck Jewellery Bijouterie Joyas Gioielleria

CrNi	Al	CuZn CuSn	Ag 925	Au 333	Au 583	Au 750	Au 916	Pt 950	ZrO₂	3D PMMA
Edelstahl Stainless inox inoxidable inox	Aluminium aluminum aluminium aluminio	Kupfer/Bronze copper/brass cuivre/laiton cobre/bronce rame/bronzo	Silber silver argent plata argento	8 Kt	14 Kt	18 Kt	22 Kt	Platino platinum platine platino platino	Zirkon zirconium zircon zircón zircono	Kunststoff acrylic résine resines resina

Ref.No.
314315



Mandrels, Werkzeugständer, Fingerlinge, Polierzopf
Mandrels, Instrument Holder, Finger Stalls, Polishing Tress
Mandrins, présentoir vide, doigts, tresse à polir
Mandriles, expositores, dediles, trenzado de pulido
Mandrini, Portastrumenti, ditali in pelle, fili per lucidare in treccia

Schraubmandrell mit Gewinde
 Screwmandrels with fits hole
 Mandrin porte-meulette
 Mandriles de tornillo con rosca
 Mandrini con filetto



Spannmandrell mit Gewinde
 Pinmandrels with fits hole
 Mandrin porte-cylindre
 Mandriles de aprisionamiento con rosca
 Mandrini a serraggio

Ø 1,7 mm 1/16"				Ø 2,5 mm 1/10"	Ø 3,0 mm 1/8"	
SM 5 HP	SM 5 HRB	SV 5 HP	SM 8 HP	SM MiMa 8 HP	SMC 5 HP	SMC 5 HP.C
313031	313032	313070	313182	313082	313115	313119

Ø 3,0 mm 1/8"
SP 3 HP*
313030

* siehe Seite 55-57
 see page 55-57
 voir page 55-57
 ver page 55-57
 vedere page 55-57

Werkzeugständer leer
 Empty instrument holder
 Présentoir vide
 Expositor vacío
 Portastrumento vuoto

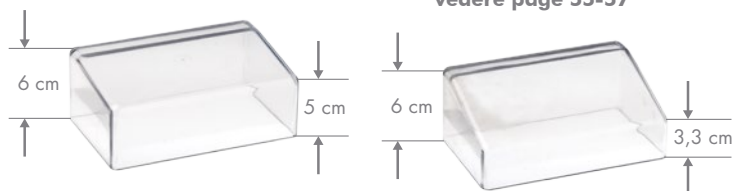

Ref.No.

313048

313045

313057

313056

Schutzkappe mit Partikelfänger
 Protector and particle collector
 Collecteur de poussière
 Colector de polvo
 Collettore di polveri



Ref.No.

314386

Fingerlinge aus Leder
 Leather finger stalls
 Doigtiers en cuir
 Dediles de cuero
 Ditali in pelle

Art.No.	Größe sizes	
PF 1	Kleiner Finger little finger petit dedo meñique Mignolo	1
PF 2	Ringfinger ring finger annulaire dedo anular Anulare	2
PF 3	Zeigefinger index finger index dedo indice Indice	3
PF 4	Daumen thumb pouce Dedo pulgar Pollice	4



Polierfäden als Zopf
 Polishing threads as tress
 Ficelle à polir comme tresse
 El trenzado de hilos de pulido
 Fili per lucidare sotto forma di treccia



157 250 PF

Ref.No.

314127

Feines Baumwollgarn, 250 Fäden
 Fine cotton yarn, 250 threads
 Fil de coton fin, 250 fils
 Hilo de algodón fino, 250 piezas
 Filo di cotone fino, 250 fili

Mattierstylos und Instrumentenreiniger
Scratch Brush Pens and Bur Cleaner
Stylos à nettoyer les outils
Lápiz para mateado y cepillo de limpiar en acero
Matita per satinare e matita con punta in acciaio



Art.Nr.
art.No.

630 00 Mattierstylo mit Glasfasereinsatz · Glass fiber matting handle
 Stylo en fibre de verre · Lápiz para mateado con recambio de fibras de vidrio
 Matita per satinare con punta in fibra di vetro

630 01 Glasfasereinsatz · Glass fiber refill · Recharge fibre de verre
 Recambio de fibras de vidrio · Ricambi in fibra di vetro

642 00 Stahlbohrereiniger mit glattem Messingdraht · Steel bur cleaner with straight brass wire
 Stylo en fil de laiton · Rascador para fresas de acero con alambre de latón liso
 Matita per pulire le frese in acciaio con punta in filo d'ottone liscio

642 01 Messingdrahteinsatz · Brass wire refill
 Recharge fil de laiton · Recambio de alambre de latón
 Ricambi in filo d'ottone liscio

682 00 Diamantschleiferreiniger mit glattem Edelstahlraht · Diamond bur cleaner with straight stainless steel wire
 Stylo en fil d'acier inoxydable lisse pour nettoyer les outils · Rascador para muelas diamantadas con alambre de acero inoxidable liso · Matita per pulire le frese diamantate con punta in filo d'acciaio inossidabile liscio

682 01 Edelstahlrahteinsatz · Stainless steel refill straight
 Recharge acier inoxydable lisse · Recambio de alambre de acero inoxidable liso
 Ricambi in filo d'acciaio liscio inossidabile liscio

692 00 HM-Bohrereiniger mit glattem Stahl · Carbide bur cleaner with straight steel wire
 Stylo en fil d'acier pour nettoyer les forets · Rascador para fresas de carburo con alambre de acero liso · Matita per pulire le frese in carburo di tungsteno con punta in filo d'acciaio liscio

692 01 Stahldrahteinsatz · Steel wire refill
 Recharge fil d'acier · Recambio de alambre de acero
 Ricambi in filo d'acciaio liscio



143 60 NI

Reinigungsbürste mit Schieblasche, gewellter Messingdraht
 Scrubbing brush with grafter, crimped brass wire
 Grattoir à fraise en fil de laiton ondulé
 Cepillo de limpieza con oreja deslizante, alambre de latón ondulado
 Nettafresa con barretta scorrevole in filo d'ottone ondulado



143 KB 30

Kratzbürste starr, gewellter Messingdraht
 Scrubbing brush with grafter, crimped brass wire
 Grattoir à fraise en fil de laiton ondulé
 Cepillo rascador rígido, alambre de latón ondulado
 Nettafresa rigido in filo d'ottone ondulado



294 55/20 Ni

Instrumentenreiniger für die Fußpflege, Nylon
 Instrument cleaner for foot care / podiatry Nylon
 Brosse en acier en pédicure, nylon

294 55/25 Ni

Cepillo de limpiar en acero para la pedicura, nylon
 Spazzolino per pulire gli strumenti per pedicura in nylon

FiberDisc

Faserverstärkte Trennscheiben
 Reinforced Fiber Discs
 Disques à tronçonner renforcés de fibres
 Muela de tronzar reforzado con fibras
 Dischi di separazione in fibra rinforzata



Info



- Ø 40 mm = 5.000 rpm
- Ø 25 mm = 10.000 rpm
- Ø 22 mm = 15.000 rpm
- Ø 20 mm = 15.000 rpm

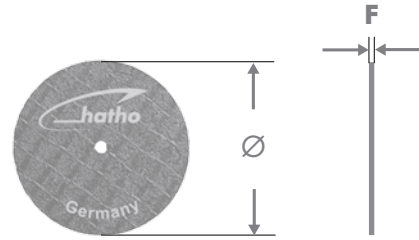

Für Metall mit Aluminium Oxide
 For metal with aluminum oxide
 Pour les alliages avec oxyde aluminium
 Para metal con óxidos de aluminio
 Per metallo con ossido di alluminio



Art.Nr. art.No.	Ø mm	F mm
654 22x02 H	22	0,2
654 22x03 H	22	0,3
654 22x05 H	22	0,5
654 25x02 H	25	0,2
654 25x03 H	25	0,3
654 25x05 H	25	0,5
654 40x05 H	40	0,5
654 40x07 H	40	0,7
654 40x10 H	40	1,0

10

Für Keramik mit Siliziumkarbid
 For ceramic with silicon carbide
 Pour la céramique avec carbure de silice
 Para cerámica con carburo de silicio
 Per ceramica con carburo di silicio

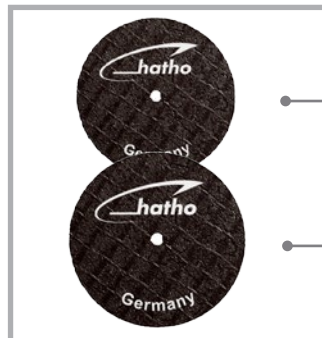

754 22x02 H	22	0,2
754 22x03 H	22	0,3
754 25x02 H	25	0,2
754 25x03 H	25	0,3

10

Für Keramik und Zirkon mit Diamant
 For ceramic and zirconium with diamond
 Pour la céramique et le zircon avec du diamant
 Para cerámica y circon con diamante
 Per ceramica e zircone con diamante



854 20x02 H	20	0,2
854 20x03 H	20	0,3

1

Naturhaarpinsel
Natural Hair Brush
Pinceau en soies naturelles
Cepillos de pelos naturales
Pennelli in setole naturali



1:1	Bezeichnung description	Art.Nr. art. No.	Größe size	Charakter character
	Tamara-Mustela 00	TK 00	00	<p>Feinstes Wieselhaar, bauchiges Haarbündel, feine stabile Pinselspitze, dreieckiger Handgriff. Finest Weasel hair, belly hair bundle, thin stable tip, triangular handle. Poils fins de martre, forme ventrue, pointe fine et stable, poignée triangulaire. Pelo de marta finísimo, mechón abombado, punta fina y firme, mango triangular Setola di martora di qualità superiore, forma della punta del pennello arrotondata, sottile e stabile, manico triangolare</p>
	Tamara-Mustela 0	TK 0	0	
	Tamara-Mustela 2	TK 2	2	
	Tamara-Mustela 4	TK 4	4	
	Tamara-Mustela 6	TK 6	6	
	Tamara-Mustela 8	TK 8	8	
	Murena-Zobel 00	MZ 00	00	<p>Feinstes Zobelhaar, kegeliges Haarbündel, flexible Pinselspitze, runder Handgriff. Finest sable hair, beveled hair bundle, thin flexible tip, round handle Poils fins de Zibeline, forme de torpédo, pointe flexible, poignée arrondie. Pelo sabeline finísimo, mechón cónico, punta blanda, mango redondo Setola di zibellino di qualità superiore, forma della punta del pennello affusolata, sottile e flessibile, manico rotondo.</p>
	Murena-Zobel 0	MZ 0	0	
	Murena-Zobel 2	MZ 2	2	
	Murena-Zobel 4	MZ 4	4	
	Murena-Zobel 6	MZ 6	6	
	Murena-Zobel 8	MZ 8	8	
	Samyra-Zobel 0	SP 0	0	<p>Feinstes Zobelhaar, flaches Haarbündel, runder Handgriff Finest sable hair, flat hair bundle, round handle Poils fins de Zibeline, plat, poignée arrondie Pelo sabeline finísimo, mechón plateado, mango redondo Setola di zibellino di qualità superiore, forma piatta della punta del pennello, manico rotondo</p>
	Samyra-Zobel 02	SP 02	02	



Spindeladapter, Musterkollektionen
Bur Chucks, Sample Collections
Porte-brossette, collection d'échantillons
Porta cepillos, colecciones de muestras
Adattatore per mandrini, Campionario di spazzole



Adapter zur Montage von Schaftbürsten auf Poliermotor
 Adapter for mounting shank brushes on conical spindle of a polishing unit
 Porte-brossette pour le montage de brosses sur tige sur les tour a polir
 Un adaptador para el montaje de los cepillos en las maquinas de pulimento
 Adattatore per utilizzare spazzolini montati sulla lucidatrice

ALUCOLOR Spindeladapter · bur chuck · Porte-brossette
 Porta cepillos · Adattatore per mandrini

						 Ø 2,34 mm 314 254	Spannzangen collets pinces pinzas morsettos
AS 400	AS 450	AS 500	AS 550	AS 600	AS 700		
314244	314245	314246	314247	314248	314250	314255	Ref.No.

FILIO®
 Spindeladapter aus Edelstahl · bur chuck from stainless steel · Porte-brossette inoxidable
 porta cepillo de acero inoxidable · Adattatore per mandrini in acciaio inossidabile

FILIO Typ A	FILIO Typ B	FILIO Typ C
314251	314252	314253

Ref.No.

Musterkollektion Miniatur- und Rundbürsten
 Sample collection miniature- and lathe brushes
 Collection d'échantillons brosses miniatures et brosses circulaires
 Colección de muestras con cepillos miniatur y cepillos para el pulido
 Campionario di spazzole „Miniatur“e dischi



Ref.No.
314184

Musterkollektion HABRAS Discs
 Sample collection HABRAS Discs
 Collection d'échantillons HABRAS Disc
 Colección de muestras con HABRAS Disc
 Campionario di spazzole „HABRAS Discs,“





Ref.No.
314243

Mattschlagbürsten
Matting Brushes
Brosses à mater
Cepillos para matar
Spazzole per satinare



MaxiMat PRO

max 2.800 rpm

			
Ø 0,20 mm	Ø 0,30 mm	Ø 0,45 mm	Ø 0,60 mm
Ref.No. 314233	Ref.No. 314234	Ref.No. 314235	Ref.No. 314236





Oberflächenstrukturen · Surface structures · Les structures de surface · Estructura superficial · Struttura delle superfici

MaxiMat PRO Federn, abgewinkelt · wires, angled · fils pliés · fillos angulados · fili piegati

			
Ø 0,20 mm	Ø 0,30 mm	Ø 0,45 mm	Ø 0,60 mm
Ref.No. 314229	Ref.No. 314230	Ref.No. 314231	Ref.No. 314232

MiniMat

max 8.000 rpm

		
Ø 0,30 mm	Ø 0,45 mm	Ø 0,60 mm
Ref.No. 314193	Ref.No. 314194	Ref.No. 314195

MiniMat Federn · threads · files · fillos · fili mini

		
Ø 0,30 mm	Ø 0,45 mm	Ø 0,60 mm
Ref.No. 314207	Ref.No. 314208	Ref.No. 314209



MiniMat Set

Ref.No.
314196



MiniMat Mandrel
 MiniMat mandrel
 MiniMat mandrin
 MiniMat mandril
 MiniMat Mandrino

Ref.No.
313082

MiniMat Arbeitsteil
 MiniMat core
 MiniMat partie travaillante
 MiniMat mandril especial
 MiniMat centro ricaricabile



Ref.No.
314203

Politur Sortimente

Polishing Kits · Assortiment de polissage

Juegos para pulido · Set per lucidare

AcryPol Set ID Nr. 313120



Politur Sortiment mit Ideal-Einlagebürsten, Mikrofaser-Lederschwabbel, feine Baumwollmulle und die Polierpaste Polistar Beige für die rationelle Hochglanzpolitur von Dentalkunststoffen aus Methylmethacrylaten.
 Polishing assortment including Ideal-Multi-Layer brushes, Microfiber-Leather polishing buff, fine cotton buff and a bar of Polishing Beige compound for high shine polishing of dental acrylics
 Assortiment de polissage avec des brosses disques intercalés Idéal, une disque en cuir microfibre, une brosse en coton et une pâte beige Polistar pour le lustrage des résines dentaires en Methylmetacrylate.
 Surtido de pulido con cepillos multicapas Ideal, disco de cuero de microfibra, gasa de algodón fina y pasta Polistar Beige para el abrillantado económico de plásticos dentales de metacrilatos metilicos
 Assortimento per lucidare contenente dischi multistrato "Ideal", disco in ecopelle microfibra, moscione con fili di cotone fini e pasta per lucidare Polistar beige in barretta per una lucidatura a specchio di resine dentali

Inhalt, contents, contenu, contenido, contenuto:
 2x 9280 / 1x 520 100/7 / 1x 156 80 HS / 1x Polistar Beige 100 g

DistoPol Set ID Nr. 313086



Politur Sortiment mit Diamantpaste und kleinen Filzkörpern für die rationelle Hochglanzpolitur von Metalllegierungen (edel und unedel), Keramiken, Kompositen, Titan
 Polishing assortment including diamond paste and miniature felt polishers for high shine polishing of all metals (precious and non-precious), ceramics, composites and titanium
 Assortiment avec une pâte diamantée et des petits feutres pour le lustrage de tous les alliages des métaux (précieux et non-précieux), céramiques, composites et titane
 Surtido de pulido con pasta de diamante y pequeñas muelas de fieltro para abrillantado económico de alcaciones metálicas (preciosas y no preciosas), cerámicas, composites y titanio
 Assortimento per lucidare contenente pasta diamantata e piccoli feltrini, per una lucidatura a specchio di tutte le leghe metalliche (nobili e vili), ceramica, compositi e titanio.

Inhalt, contents, contenu, contenido, contenuto:
 1x Polistar Diamant 1,5 g / 6x 174 12x3 / 6x 175 12 UM / 1x SM 5 HP

CeroPol Set ID Nr. 313087



Politur Sortiment mit Diamantpaste und Kombibürsten für die rationelle Hochglanzpolitur von Metalllegierungen (edel und unedel), Keramiken, Kompositen, Titan
 Polishing assortment including diamond paste and Kombi brushes for high shine polishing of all metals (precious and non-precious), ceramics, composites and titanium
 Assortiment de polissage avec une pâte diamantée et une combinaison de brossettes pour le lustrage de tous les alliages de métaux (précieux et non-précieux), céramiques, composites et titane.
 Surtido de pulido con pasta de diamante y cepillos Kombi para el abrillantado económico de alcaciones metálicas (preciosas y no preciosas), cerámicas, composites y titanio
 Assortimento per lucidare contenente pasta diamantata e spazzolini "Kombi", per una lucidatura a specchio di leghe metalliche (nobili e vili), ceramica, compositi e titanio

Inhalt, contents, contenu, contenido, contenuto:
 1x Polistar Diamant 2,5 g / 3x 100/500 22 HP / 3x 102/500 22 HP

Polistar Koffer ID Nr. 313140



Politur Sortiment mit ZETA Tuschschwabbel, schmale Baumwollmulle und die Polierpaste Polistar Lintygrau zur Vorpolitur sowie eine Flasche Emulsion für die Abschlusspolitur von Dentalkunststoffen aus Methylmethacrylaten
 Polishing assortment including ZETA cloth buff, small cotton buff, a bar of Polishing Lintygrey compound for the pre-polishing and Polistar Emulsion for the final gloss polishing of dental acrylics
 Assortiment de polissage avec un disque en toile ZETA, une brosse en coton étroite et la pâte à polir, Polistar linygris pour le prépolissage final des résines dentaires en Methylmetacrylate.
 Surtido de pulido con dico de paño ZETA, gasa de algodón estrecha y pasta Polistar Lintygris para el prepolido así como un frasco de emulsión para el pulido final de plásticos dentales de metacrilatos metilicos.
 Assortimento per lucidare contenente disco in panno "ZETA", moscione con fili di cotone sottili, pasta Polistar Lintygrigio per prelucidare e Polistar Emulsione in flacone per la lucidatura finale della resina dentale.

Inhalt, contents, contenu, contenido, contenuto:
 1x 862 80/15 / 1x 152 80 BW / 1x Polistar Lintygrau 300 g / 1x Polistar Emulsion 125 ml

ThermoPol Set ID Nr. 313203

RapidPol Set ID Nr. 313210



3 Schritte-Poliererset für thermoplastische Kunststoffe. Schnelle Vorpolitur mit Einlegebürste und Polistar Lintygrau. Effektive Glanzpolitur mit COSIMA Soft Schwabbel + Creme. Perfekten Hochglanz mit Polistar Pro Pink.
 3 Steps Thermoplastic Polishing Kit. Fast and easy pre-polishing with Scotch Brite™ Multi Layer brush and Polistar Lintygrey. Effective shine polishing with COSIMA Soft buff + Cream. Perfect high shine polishing with Polistar Pro Pink.
 Kit de 3 étapes de polissage pour polir les thermoplastiques. Pré-polissage rapide avec brosse intercalé et Polistar Lintygris. Poli brillant avec la disque COSIMA Soft et crème à polir Polistar. Lustrage avec la pate à polir Polistar Pro Pink
 Tres pasos para termoplástico. Prepulido rápido con cepillo con entretelas y Polistar Lintygris. Pulido efectivo con disco de COSIMA Soft + Crema. Abrillantado perfecto con Polistar Pro Pink
 Set per lucidare le resine in termoplastica in tre passaggi. Veloce prelucidatura con il disco multistrato e la pasta per lucidare Polistar Lintygrigio. Effettiva lucidatura con i dischi COSIMA morbidi + crema. Una perfetta lucidatura a specchio con Polistar Pro Pink.

Inhalt, contents, contenu, contenido, contenuto:
 1x Polistar Lintygrau 90g / 2x 4280 / 1x Polistar Creme 90g / 1x 869 100/14 / 1x Polistar Pro Rosa 150g / 1x 868 4"x50 H

§ 1 Geltungsbereich – Vertragsgegenstand

(1) Unsere AGB gelten für die Herstellung und Lieferung von beweglichen Sachen nach Maßgabe des zwischen uns und dem Kunden geschlossenen Vertrags. Sie richten sich ausschließlich an natürliche oder juristische Personen oder rechtsfähigen Personengesellschaften in Ausübung ihrer gewerblichen oder selbständigen beruflichen Tätigkeit (Unternehmer).

(2) Unsere AGB gelten ausschließlich. Entgegenstehende oder von unseren AGB abweichende Bedingungen des Kunden erkennen wir nicht an, es sei denn, wir haben ausdrücklich schriftlich ihrer Geltung zugestimmt.

(3) Unsere AGB gelten auch dann, wenn wir in Kenntnis entgegenstehender oder von unseren Geschäftsbedingungen abweichender Bedingungen des Kunden die Lieferung vorbehaltlos ausführen. Sie gelten auch für alle zukünftigen Lieferungen, Leistungen oder Angebote an den Kunden, auch wenn sie nicht nochmals gesondert vereinbart werden.

§ 2 Angebot – Vertragsschluss

(1) Die Bestellung des Kunden stellt ein bindendes Angebot dar, das wir innerhalb von zwei Wochen durch Zusendung einer Auftragsbestätigung oder durch Lieferung der Ware annehmen können. Vorher abgegebene Angebote durch uns sind freibleibend und unverbindlich.

(2) An Abbildungen, Zeichnungen, Kalkulationen und sonstigen Unterlagen behalten wir uns Eigentums- und Urheberrechte vor. Dies gilt auch für solche schriftlichen Unterlagen, die als vertraulich bezeichnet sind. Vor ihrer Weitergabe an Dritte bedarf der Kunde unserer ausdrücklichen schriftlichen Zustimmung.

§ 3 Preise und Zahlungsbedingungen

(1) Es gilt unsere zum Zeitpunkt des Vertragsschlusses gültige Preisliste für den in der Auftragsbestätigung aufgeführten Leistungs- und Lieferungsumfang. Die Preise verstehen sich in EURO ab Werk zuzüglich Verpackung, Versand, gesetzlicher Umsatzsteuer sowie gegebenenfalls Zoll, Gebühren und anderer öffentlicher Abgaben.

(2) Hat sich der Preis zum Zeitpunkt der Leistungserbringung durch eine Änderung des Marktpreises oder durch Erhöhung der von in die Leistungserbringung einbezogenen Dritten verlangten Entgelte erhöht, gilt der höhere Preis. Liegt dieser 20 % oder mehr über dem vereinbarten Preis, hat der Kunde das Recht, vom Vertrag zurückzutreten. Dieses Recht unverzüglich nach Mitteilung des erhöhten Preises geltend gemacht werden.

(3) Die Gesamtvergütung ist unmittelbar mit Rechnungsstellung fällig und ohne jeden Abzug zu zahlen, sofern nichts anderes vereinbart ist. Zahlungen sollen nur durch Banküberweisung erfolgen. Wechsel- und Scheckzahlungen erkennen wir nicht als Erfüllung an.

(4) Leistet der Kunde bei Fälligkeit nicht, so sind die ausstehenden Beträge nach §§ 352, 353 HGB ab dem Tag der Fälligkeit mit 5 % jährlich zu verzinsen. Zahlt der Kunde innerhalb von 21 Tagen ab Rechnungsstellung nicht, kommt er in Verzug, ohne dass es hierfür einer Mahnung bedarf. Der Kaufpreis ist während des Verzugs mit 8 Prozentpunkten über dem Basiszinssatz jährlich zu verzinsen. Die Geltendmachung weiterer Rechte aus Verzug des Kunden behalten wir uns vor.

(5) Aufrechnungsrechte und Zurückbehaltungsrechte stehen dem Kunden nur zu, wenn seine Gegenansprüche rechtskräftig festgestellt, unbestritten oder von uns anerkannt sind.

§ 4 Lieferung - Gefahrübergang – Leistungszeit

(1) Sofern sich aus der Auftragsbestätigung nichts anderes ergibt, ist Lieferung ab Werk vereinbart.

(2) Wir sind berechtigt, uns zur Erfüllung unserer vertraglichen Lieferverpflichtungen Dritter zu bedienen. Die Gefahr geht spätestens mit der Übergabe des Liefergegenstandes an den Spediteur, Frachtführer oder sonst zur Ausführung bestimmten Dritten auf den Kunden über. Dies gilt auch für Teillieferungen. Verzögert sich der Versand oder die Übergabe infolge eines Umstandes, dessen Ursache beim Kunden liegt, geht die Gefahr von dem Tag an auf den Kunden über, an dem der Liefergegenstand versandbereit ist und der Verkäufer dies dem Kunden angezeigt hat.

(3) Sind von uns Lieferfristen angegeben und zur Grundlage für die Auftragserteilung gemacht worden, verlängern sich solche Fristen bei Streik und höherer Gewalt für die Dauer der Verzögerung.

§ 5 Haftung für Mängel

(1) Bei Vorliegen eines Mangels behalten wir uns die Wahl der Art der Nacherfüllung (Nachbesserung oder Ersatzlieferung) vor.

(2) Die Gewährleistungsfrist beträgt ein Jahr ab Lieferung. Dies gilt nicht, soweit es sich um Schadensersatzansprüche wegen Mängeln handelt. Für Schadensersatzansprüche wegen eines Mangels gilt § 6. Die Verjährungsfrist im Fall eines Lieferregresses nach den §§ 478, 479 BGB bleibt unberührt.

§ 6 Haftung für Schäden

(1) Unsere Haftung für vertragliche Pflichtverletzungen sowie aus Delikt ist auf Vorsatz und grobe Fahrlässigkeit beschränkt. Dies gilt nicht bei Verletzung von Leben, Körper und Gesundheit des Kunden und bei Verletzung von Kardinalpflichten, d.h. von solchen Pflichten, die sich aus der Natur des Vertrags ergeben und bei deren Verletzung die Erreichung des Vertragszwecks gefährdet ist. Insoweit haften wir für jeden Grad des Verschuldens. Für Schäden, die nicht aus der Verletzung von Leben, Körper und Gesundheit des Kunden resultieren, haften wir jedoch nur für den vertragstypischen, vorhersehbaren Schaden.

(2) Die vorgenannte Haftungsbeschränkung gilt auch für leicht fahrlässige Pflichtverletzungen unserer Erfüllungsgehilfen.

(3) Soweit eine Haftung für Schäden, die nicht auf der Verletzung von Leben, Körper oder Gesundheit des Kunden beruhen, für leichte Fahrlässigkeit nicht ausgeschlossen ist, verjähren derartige Ansprüche innerhalb eines Jahres. Die Verjährung beginnt mit der Entstehung des Anspruchs, bei Schadensersatzansprüchen wegen eines Mangels ab Übergabe der Sache.

(4) Soweit die Schadensersatzhaftung uns gegenüber ausgeschlossen oder eingeschränkt ist, gilt dies auch im Hinblick auf die persönliche Schadensersatzhaftung unserer Angestellten, Arbeitnehmer, Mitarbeiter, Vertreter und Erfüllungsgehilfen.

(5) Die Vorschriften des Produkthaftungsgesetzes bleiben unberührt.

§ 7 Eigentumsvorbehalt

(1) Wir behalten uns das Eigentum an der Ware bis zur Erfüllung sämtlicher Forderungen gegen den Kunden vor, auch wenn die konkrete Ware bereits bezahlt wurde.

(2) Über Zwangsvollstreckungsmaßnahmen Dritter in die Vorbehaltsware hat uns der Kunde unverzüglich unter Übergabe der für eine Intervention notwendigen Unterlagen zu unterrichten. Unabhängig davon hat der Kunde die die Zwangsvollstreckung betreibenden Gläubiger auf die an der Ware bestehenden Rechte hinzuweisen. Der Kunde hat die Kosten unserer Intervention zu tragen, wenn der die Zwangsvollstreckung betreibende Dritte nicht in der Lage ist, diese zu erstatten.

(3) Für den Fall der Weiterveräußerung der Vorbehaltsware tritt uns der Kunde schon jetzt bis zur Erfüllung aller unserer Ansprüche die ihm aus der Weiterveräußerung entstehenden Forderungen gegen seine Kunden zur Sicherheit ab. Bei einer Verarbeitung der Vorbehaltsware, ihrer Umbildung oder ihrer Verbindung mit einer anderen Sache erwerben wir unmittelbar Eigentum an der hergestellten Sache. Diese gilt als Vorbehaltsware.

(4) Übersteigt der Wert der Sicherung unsere Ansprüche gegen den Kunden um mehr als 20 %, so haben wir auf Verlangen des Kunden und nach unserer Wahl uns zustehende Sicherheiten in entsprechendem Umfang freizugeben.

§ 8 Verjährung eigener Ansprüche

Unsere Ansprüche auf Zahlung verjähren abweichend von § 195 BGB in fünf Jahren. Hinsichtlich des Verjährungsbeginns gilt § 199 BGB.

§ 9 Form von Erklärungen

Rechtserhebliche Erklärungen und Anzeigen und die der Kunde gegenüber uns oder einem Dritten abzugeben hat, bedürfen der Schriftform.

§ 10 Erfüllungsort – Rechtswahl – Gerichtsstand

(1) Soweit sich aus dem Vertrag nichts anderes ergibt, ist Erfüllungsort und Zahlungsort unser Geschäftssitz.

(2) Für diesen Vertrag gilt das Recht der Bundesrepublik Deutschland unter Ausschluss des UN-Kaufrechts.

(3) Ausschließlicher Gerichtsstand ist bei Verträgen mit Kaufleuten, juristischen Personen des öffentlichen Rechts oder öffentlich-rechtlichen Sondervermögen das für unseren Geschäftssitz zuständige Gericht.

Art.Nr. art.no.	Seite page	Art.Nr. art.no.	Seite page	Art.Nr. art.no.	Seite page	Art.Nr. art.no.	Seite page	Art.Nr. art.no.	Seite page	Art.Nr. art.no.	Seite page	Art.Nr. art.no.	Seite page	Art.Nr. art.no.	Seite page	Art.Nr. art.no.	Seite page	Art.Nr. art.no.	Seite page	Art.Nr. art.no.	Seite page
0144	8	102 10 HP	58	112 s6 HP	52	120 p11 HP	55	121 p6 UML	55	142 22 H.P.C	38	144 16 H.P.C	38	160 125x24 K	27	173 9 HP	47	182 10 PP.B	58		
0250	9	102 10 HP.B	58	112 s6 HP.B	52	120 p11 HP.B	55	121 p7 HP	55	142 22 RED	38	144 16 RED	38	160 125x30 K	27	173 9 HP.B	47	182 12 HP	60		
0250 H	9	102 10 PP	58	112 s6 H.P.C	52	120 p11 H.P.C	55	121 p7 HP.B	55	142 22 UM	38	144 16 UM	38	160 14 HP	60	174 100x20	46	182 12 HP.B	60		
0255	9	102 10 PP.B	58	112 s6 UM	52	120 p12 HP	55	121 p7 H.P.C	55	142 22 UMC	38	144 16 UMC	38	160 14 HP.B	60	174 12x3 036	46	182 12 UM	60		
0255 H	9	102 10 PPM	58	1135	8	120 p12 HP.B	55	121 p8 HP	55	142 e8 H.P.C	56	144 19 HP	38	160 14 UM	60	174 17 HP	47	182 14 HP	60		
0355	11	102 10 PPM.B	58	1144	8	120 p12 H.P.C	55	121 p8 HP.B	55	142 g6 HP	56	144 19 HP.B	38	160 16(MC) HP	44	174 17 HP.B	47	182 14 HP.B	60		
037	12	102 16 HP	36	1145	8	120 p13 HP	55	121 p9 HP	55	142 p11 HP	56	144 19 H.P.C	38	160 19(MC) HP	44	174 17 RED	46	182 14 UM	60		
0370	11	102 16 HP.B	36	115 10 HP	58	120 p13 HP.B	55	121 p9 HP.B	55	142 p11 HP.B	56	144 19 RED	38	160 22 HP	44	174 17 UM	46	182 16 HP	37		
0480	13	102 16 H.P.C	36	115 10 HP.B	58	120 p13 H.P.C	55	121 p9 H.P.C	55	142 p11 H.P.C	56	144 19 UM	38	160 22 UM	44	174 19 HP	47	182 16 HP.B	37		
100 10 HP	58	102 16 RED	36	115 10 PP	58	120 p6 UM	55	121 s4 HP	52	142 p6 UM	56	144 19 UMC	38	160 22(MC) HP	44	174 19 RED	46	182 16 HP.C	37		
100 10 HP.B	58	102 16 UM	36	115 10 PP.B	58	120 p6 UML	55	121 s4 HP.B	52	142 g6 UML	56	144 22 HP	38	160 22g HP	45	174 19 UM	46	182 16 RED	37		
100 10 PP	58	102 16 UMC	36	115 10 PPM	58	120 p7 HP	55	121 s5 HP	52	142 p7 HP	56	144 22 HP.B	38	160 22g UM	45	174 21 HP	47	182 16 UM	37		
100 10 PP.B	58	102 16(MC) HP	36	115 10 PPM.B	58	120 p7 HP.B	55	121 s5 HP.B	52	142 p7 HP.B	56	144 22 H.P.C	38	160 25g HP	45	174 21 HP.B	47	182 16 UMC	37		
100 10 PPM	58	102 16(MC) HP.B	36	115 12 HP	59	120 p7 H.P.C	55	121 s5 H.P.C	52	142 p7 H.P.C	56	144 22 RED	38	160 25g UM	45	174 21 RED	46	182 19 HP	37		
100 10 PPM.B	58	102 16(MC) UM	36	115 12 UM	59	120 p8 HP	55	121 s5 UM	52	142 p8 HP	56	144 22 UM	38	160 28g HP	45	174 21 UM	46	182 19 HP.B	37		
100 12 HP	59	102 19 HP	36	115 14 HP	59	120 p8 HP.B	55	121 s6 HP	52	142 p8 HP.B	56	144 22 UMC	38	160 80 NE/30	22	174 21x4 056	46	182 19 H.P.C	37		
100 12 UM	59	102 19 HP.B	36	115 14 UM	59	120 p8 H.P.S	57	121 s6 HP.B	52	142 s4 HP	53	144 e8 HP.C	56	160 80 NE/45	22	174 21x9 HP	47	182 19 RED	37		
100 14 HP	59	102 19 H.P.C	36	115 23 HP	50	120 p9 HP	55	121 s6 H.P.C	52	142 s4 HP.B	53	144 g6 HP	54	161 100/20	24	174 25 HP	46	182 19 UM	37		
100 14 UM	59	102 19 RED	36	115 23 HP.B	50	120 p9 HP.B	55	121 s6 UM	52	142 s5 HP	53	144 p10 HP	56	161 12 HP	60	174 25 H.P.C	47	182 19 UMC	37		
100 16 HP	36	102 19 UM	36	115 23 H.P.C	50	120 p9 H.P.C	55	1250	9	142 s5 HP.B	53	144 p10 HP.B	56	161 12 UM	60	174 25 UM	46	182 22 HP	37		
100 16 HP.B	36	102 19 UMC	36	115 23 UM	50	120 s4 HP	52	1245	9	142 s5 UM	53	144 p10 H.P.C	56	161 125x24 K	26	174 25x4 028	46	182 22 HP.B	37		
100 16 H.P.C	36	102 19(MC) HP	36	115 25 HP	50	120 s4 HP.B	52	1255	9	142 s6 HP	53	144 p11 HP	56	161 125x30 K	26	174 25x5 028	46	182 22 H.P.C	37		
100 16 RED	36	102 19(MC) HP.B	36	115 25 HP.B	50	120 s5 HP	52	1259	10	142 s6 HP.B	53	144 p11 HP.B	56	161 14 HP	60	174 25x5 056	46	182 22 RED	37		
100 16 UM	36	102 19(MC) UM	36	115 25 H.P.C	50	120 s5 HP.B	52	1250 H	9	142 s6 H.P.C	53	144 p11 H.P.C	56	161 14 UM	60	174 25x5 065	46	182 22 UM	37		
100 16 UMC	36	102 22 HP	36	115 25 UM	50	120 s5 H.P.C	52	1255 H	9	142 s6 UM	53	144 p7 HP	56	161 19 HP	45	174 25x6 030	46	182 22 UMC	37		
100 16(MC) HP	36	102 22 HP.B	36	115 28 HP	50	120 s5 UM	52	1260	10	143 12 HP	59	144 p7 HP.B	56	161 19 HP.B	45	174 25x8 056	46	182 e8 HP.C	56		
100 16(MC) HP.B	36	102 22 H.P.C	36	115 28 HP.B	50	120 s6 HP	52	1265	10	143 12 UM	59	144 p7 H.P.C	56	161 19 UM	45	174 25x10 HP	47	182 g6 HP	54		
100 16(MC) UM	36	102 22 RED	36	115 28 H.P.C	50	120 s6 HP.B	52	1260 H	10	143 14 HP	59	144 p8 HP	56	161 19 UM	45	174 30x10	46	182 p11 HP.B	56		
100 19 HP	36	102 22 UM	36	115 28 UM	50	120 s6 H.P.C	52	1265 H	10	143 14 UM	59	144 p8 HP.B	56	161 22 HP	45	174 40x10	46	182 p11 HP.C	56		
100 19 HP.B	36	102 22 UMC	36	115 32 HP	50	120 s6 UM	52	1270	10	143 16 HP	59	144 s5 HP	53	161 22 HP.B	45	174 50x10	46	182 p11 HP	56		
100 19 HP.C	36	102 23 HP	50	115 32 HP.B	50	121 10 HP	58	1270 H	10	143 16 HP.B	38	144 s5 UM	53	161 22 H.P.C	45	174 60x13	46	182 p6 UM	56		
100 19 RED	36	102 23 HP.B	50	115 32 H.P.C	50	121 10 HP.B	58	1280 H	10	143 16 H.P.C	38	144 s6 HP	53	162 100/6	24	174 80x20	46	182 p6 UML	56		
100 19 UM	36	102 23 H.P.C	50	115 32 UM	50	121 10 PP	58	1355	11	143 16 RED	38	144 s6 HP.B	53	162 110 FI/12	22	174 80x25	46	182 p7 HP	56		
100 19 UMC	36	102 23 UM	50	115 s5 HP	52	121 10 PP.B	58	1355 H	11	143 16 UM	38	144 s6 H.P.C	53	162 110 FI/6	22	174 25x10 HP	47	182 p7 HP.B	56		
100 19(MC) HP	36	102 25 HP	50	115 s5 HP.B	52	121 10 PPM	58	1360 H	11	143 16 UMC	38	144 s6 UM	53	162 12 HP	60	174 FL 20x10x1 HP	47	182 p7 H.P.C	56		
100 19(MC) HP.B	36	102 25 HP.B	50	115 s5 H.P.C	52	121 10 PPM.B	58	137 H	12	143 19 HP	38	145 60 HP.6	21	162 12 UM	60	174 FL 20x10x1 HP.B	47	182 p8 HP	56		
100 19(MC) UM	36	102 25 H.P.C	50	115 s6 HP	52	121 12 HP	59	1370	11	143 19 HP.B	38	145 s6 HP	53	162 125x24 K	26	174 FL 20x10x1 H.P.C	47	182 p8 HP.B	56		
100 22 HP	36	102 25 UM	50	115 s6 HP.B	52	121 12 HP.B	59	137 H	12	143 19 H.P.C	38	145 s6 HP.B	53	162 125x30 K	26	174 FL 30x20x4 HP	47	182 s5 HP	53		
100 22 HP.B	36	102 28 HP	50	115 s6 H.P.C	52	121 12 UM	59	1370 H	11	143 19 RED	38	1460	12	162 14 HP	60	174 FL 30x20x4 HP.B	47	182 s5 UM	53		
100 22 H.P.C	36	102 28 HP.B	50	115 H	8	121 14 HP	59	138	12	143 19 UM	38	146 EH	14	162 14 HP.B	60	174 FL 30x20x4 H.P.C	47	182 s6 HP	53		
100 22 RED	36	102 28 H.P.C	50	1160 H	8	121 14 HP.B	59	138 H	12	143 19 UMC	38	146 H/EH	14	162 14 UM	60	175 12x3	46	182 s6 HP.B	53		
100 22 UM	36	102 28 UM	50	1165 H	9	121 14 H.P.C	59	1380 H	11	143 22 HP	38	1460 H	12	162 22 HP	45	175 17 HP	47	182 s6 H.P.C	53		
100 22 UMC	36	102 32 HP	50	120 10 HP	58	121 14 UM	59	1399 H	12	143 22 HP.B	38	1465 H	12	162 22 HP.B	45	175 17 HP.B	47	182 s6 HP	53		
100 23 HP	50	102 32 HP.B	50	120 10 HP.B	58	121 16 HP	36	141 12 HP	59	143 22 H.P.C	38	147 H	14	162 22 H.P.C	45	175 17x4	46	182 s6 UM	53		
100 23 HP.B	50	102 32 H.P.C	50	120 10 PP	58	121 16 HP.B	36	141 12 HP.B	59	143 22 RED	38	1470 H	12	162 22 UM	45	175 19 HP	47	182 12 HP	60		
100 23 H.P.C	50	102 32 UM	50	120 10 PP.B	58	121 16 H.P.C	36	141 12 UM	59	143 22 UM	38	1475 H	13	162 25 HP	45	175 19 HP.B	47	182 12 HP.B	60		
100 23 UM	50	102 48	19	120 10 PPM	58	121 16 RED	36	141 14 HP	59	143 22 UMC	38	148	14	162 25 HP.B	45	175 19x4.5	46	183 14 HP	60		
100 25 HP	50	102 s5 HP	52	120 10 PPM.B	58	121 16 UM	36	141 14 HP.B	59	143 23 HP	51	1480	13	162 25 H.P.C	45	175 21 HP	47	183 14 HP	60		
100 25 HP.B	50	102 s5 HP.B	52	120 12 HP	59	121 16 UMC	36	141 14 UM	59	143 23 HP.B	51	148 H	14	162 25 UM	45	175 21 HP.B	47	183 14 HP.B	60		
100 25 H.P.C	50	102 s5 H.P.C	52	120 12 HP.B	59	121 16(MC) HP	36	141 16 HP	38	143 23 H.P.C	51	148 H/EH	14	162 80 FI/12	22	175 21x5	46	183 16 HP	60		
100 25 UM	50	102 s5 UM	52	120 12 UM	59	121 16(MC) HP.B	36	141 16 HP.B	38	143 23 UM	51	1480 EH	13	162 80 FI/6	22	175 25x7	46	183 16 HP.B	37		
100 28 HP	50	102 s6 HP	52	120 14 HP	59	121 19 HP	36	141 16 H.P.C	38	143 25 HP	51	1480 H	13	163 100/40	24	175 30x7	46	183 16 H.P.C	37		
100 28 HP.B	50	102 s6 HP.B	52	120 14 HP.B	59	121 19 HP.B	36	141 16 RED	38	143 25 HP.B	51	1480 H/EH	13	163 125x24 K	26	175 40x10	46	183 16 RED	37		
100 28 H.P.C	50	102 s6 H.P.C	52	120 14 UM	59	121 19 HP.C	36	141 16 UM	38	143 25 H.P.C	51	1499 H	14	163 125x30 K	26	175 50x10	46	183 16 UM	37		
100 28 UM	50	102 s6 UM	52	120 16 HP	36	121 19 H.P.C	36	141 16 UMC	38	143 25 UM	51	150 10 HP	58	164 100/20	24	175 60x13	46	183 16 UMC	37		
100 32 HP	50	102/500 22 HP	39	120 16 HP.B	36	121 19 RED	36	141 19 HP	38	143 28 HP	51	150 10 HP.B	58	164 100/40	24	176 17 HP	47	183 19 HP	37		
100 32 HP.B	50	102/520 22 HP	39	120 16 H.P.C	36	121 19 UMC	36	141 19 HP.B	38	143 28 HP.B	51	150 10 PP	58	164 100/55	24	176 19 HP	47	183 19 HP.B	37		
100 32 H.P.C	50	102/862 22 HP	39	120 16 RED	36	121 19 H.P.C	36	141 19 HP.C	38	143 28 H.P.C	51	150 10 PP.B	58	164 12 HP	60	176 19 HP.B	47	183 19 HP.C	37		
100 3																					

Art.Nr.	Seite	Art.Nr.	Seite	Art.Nr.	Seite	Art.Nr.	Seite	Art.Nr.	Seite	Art.Nr.	Seite	Art.Nr.	Seite	Art.Nr.	Seite	Art.Nr.	Seite	Art.Nr.	Seite	Art.Nr.	Seite	Art.Nr.	Seite
183 s5 HPB	53	193 19 RED	37	202 8 HPB	48	250 40/3 HPB	49	282 p7 HPC	55	288 22 HPB	38	402 p8 HPC	30	520 80 CH/6	22	868 6"x75 H	29	905 51x4 HP6	34	Polistar Beige 300 g	64		
183 s5 UM	53	193 19 UM	37	202 8 HPC	48	250 51	49	282 p8 HP	55	288 22 HPC	38	402 s6 HP	30	520 90 LE	16	869 100/14	25	905 76x4	34	Polistar Blau 1,2 kg	64		
183 s6 HP	53	193 19 UMC	37	203 12 HPB	49	250 80 VL/2	48	282 p9 HPC	55	288 22 RED	38	402 s6 HPB	30	520 90	16	869 100/20	25	905 76x4 HP6	34	Polistar Blau 100 g	64		
183 s6 HPB	53	193 22 HP	37	203 12 HPC	49	250 80 VL/4	48	282 p9 HP	55	288 22 UM	38	402 s6 HPC	30	5365	16	869 100/28	25	906 14 HP	32	Polistar Blau 300 g	64		
183 s6 HPC	53	193 22 HPB	37	204 20 HP	48	251 110 VL/2	48	282 p9 HPB	55	288 22 UMC	38	404 19 HP	30	5380	16	869 125x24 K	27	906 14 HPB	32	Polistar Blau Pro 150 g	65		
183 s6 UM	53	193 22 HPC	37	204 20 HPC	48	251 110 VL/4	48	282 p9 HPC	55	294 55/20 NI	67	404 19 HPB	30	5480	16	869 125x30 K	27	906 14 R/4	32	Polistar Booklet	66		
184 12 HP	60	193 22 RED	37	204 20 HPC	48	251 25 HP	48	282 s4 HP	53	293 55/25 NI	67	404 19 HPC	30	550/4g/50/90 H	15	869 12 HP	61	906 14 R/48	32	Polistar Braun 1,2 kg	64		
184 12 UM	60	193 22 UM	37	204 20 R	48	251 25 HPB	48	282 s4 HPB	53	334 4 HP	62	404 19 HPC	31	550/4s/50/90 H	15	869 12 UM	61	906 14 R/48	32	Polistar Braun 100 g	64		
184 14 HP	60	193 22 UMC	37	204 20 HPC	48	251 25 HPC	49	282 s5 HP	53	334 11 HP	62	404 22 HP	30	630 00	67	869 14 UM	61	906 19 HPB	32	Polistar Braun 300 g	64		
184 14 UM	60	193 23 HP	51	204 22 HPB	48	251 25 RED	49	282 s5 HPB	53	334 12 UM	62	404 22 HPC	30	630 01	67	869 14 HP	61	906 19 R/4	32	Polistar Creme	64		
184 16 HP	37	193 23 HPB	51	204 22 HPC	48	251 25 UM	48	282 s5 UM	53	346 22 R	63	404 22 HPB	30	6380	67	869 22 HP	44	906 19 R/48	32	Polistar Diamant 1,5 g	65		
184 16 HPB	37	193 23 HPC	51	205 17 HP	49	251 30/3 HPB	48	282 s6 HP	53	346 22 R	63	404 22 RED	31	642 00	67	869 22 HPB	44	906 51x4	35	Polistar Diamant 2,5 g	65		
184 16 HPC	37	193 23 UM	51	205 17 HPB	49	251 40/3 HPB	48	282 s6 HPB	53	356 22 HP	62	404 22 UM	31	642 01	67	869 22 HPC	44	906 51x4 HP6	35	Polistar Emulsion 125 ml	65		
184 16 RED	37	193 25 HP	51	205 17 HPC	49	251 80 VL/2	48	282 s6 HPC	53	356 22 HPB	62	404 25 HP	30	642 19 HP	38	869 22 UM	44	906 76x4	35	Polistar Emulsion 50 ml	65		
184 16 UM	37	193 25 HPB	51	206 8 HP	49	251 80 VL/4	48	282 s6 UM	53	356 22 HPC	62	404 25 HPB	30	642 19 HPB	38	869 22 RED	44	906 76x4 HP6	35	Polistar Grün 1,2 kg	64		
184 16 UMC	37	193 25 HPC	51	206 8 HPB	49	252 110 VL/2	49	283 16 HP	38	356 p8 HP	62	404 25 HPC	30	642 19 HPC	38	869 51	20	907 14 HP	32	Polistar Grün 100 g	64		
184 19 HP	37	193 25 UM	51	206 8 HPC	49	252 110 VL/4	49	283 16 HPB	38	356 p8 HPB	62	404 42	31	642 19 RED	38	869 60	20	907 14 HPB	32	Polistar Grün 300 g	64		
184 19 HPB	37	193 28 HP	51	210 6 HP	49	252 80 HP	49	283 16 HPC	38	356 s6 HPC	62	404 51	31	642 19 UM	38	870 100/14	25	907 14 R/4	32	Polistar Koffer	72		
184 19 HPC	37	193 28 HPB	51	210 6 HPC	49	252 80 VL/4	49	283 16 RED	38	356 s6 HP	62	404 p8 HP	30	642 22 HP	38	870 100/22	25	907 14 R/48	32	Polistar Lintygrau 1,2 kg	64		
184 19 RED	37	193 28 HPC	51	210 6 HPB	49	253 110 VL/2	49	283 16 UM	38	356 s6 HPB	62	404 p8 HPB	30	642 22 HPC	38	870 100/22 K	27	907 19 HP	32	Polistar Lintygrau 90 g	64		
184 19 UM	37	193 28 UM	51	212 6 HP	48	253 110 VL/4	49	283 16 UMC	38	356 s6 HPC	62	404 p8 HPC	30	642 22 HPC	38	870 125x30 K	27	907 19 HPB	32	Polistar Lintygrau 300 g	64		
184 19 UMC	37	193 32 HP	51	212 6 HPB	48	253 25 HP	42	283 19 HP	38	358 22 HP	62	404 s6 HP	30	642 22 RED	38	870 12 HP	61	907 19 R/4	32	Polistar Orange Pro 150 g	65		
184 22 HP	37	193 32 HPB	51	212 6 HPC	48	253 25 HPB	58	283 19 HPB	38	358 22 HPB	62	404 s6 HPB	30	642 22 UM	38	870 12 UM	61	907 19 R/48	32	Polistar Pink Pro 150 g	65		
184 22 HPB	37	193 32 HPC	51	212 8 HP	48	253 25 HPC	58	283 19 HPC	38	358 22 HPC	62	404 s6 HPC	30	6480	16	870 14 HP	61	907 51x4	35	Polistar Rosa 1,2 kg	64		
184 22 HPC	37	193 32 UM	51	212 8 HPB	48	253 25 RED	49	283 19 HPB	38	358 p8 HP	62	410 19 HP	30	654 22x02 H	68	870 14 UM	61	907 51x4 HP6	35	Polistar Rosa 100 g	64		
184 22 RED	37	193 45 HP6	21	212 8 HPC	48	253 25 UM	58	283 19 UM	38	358 p8 HPB	62	410 19 HPB	30	654 22x03 H	68	870 22 HP	44	907 76x4	35	Polistar Rosa 300 g	64		
184 22 UM	37	193 51	19	212 12 HPB	49	253 51	23	283 19 UMC	38	358 s6 HPC	62	410 19 HPC	30	654 22x05 H	68	870 22 HPB	44	907 76x4 HP6	35	Polistar Rot 1,2 kg	64		
184 22 UMC	37	193 51 HP6	21	212 12 HPC	49	253 80 VL/2	23	283 22 HP	38	358 s6 HP	62	410 19 UM	31	654 25x02 H	68	870 22 HPC	44	908 25 R/4	33	Polistar Rot 100 g	64		
184 e8 HPC	56	193 e8 HPC	57	213 12 HPB	48	253 80 VL/4	61	283 22 HPB	38	358 s6 HPB	62	410 22 HP	30	654 25x03 H	68	870 22 UM	44	908 25 R/48	33	Polistar Rot 300 g	64		
184 p10 HP	56	193 g6 HP	54	213 12 HPC	48	254 25 HP	61	283 22 HPC	38	358 s6 HPC	62	410 22 HPB	30	654 25x05 H	68	870 22 RED	44	908 25(3) HP	33	Polistar Weiß 1,2 kg	64		
184 p10 HPB	56	193 p10 HP	57	214 20 HP	48	254 25 HPB	42	283 22 RED	38	360 22 HP	62	410 22 HPC	30	654 40x05 H	68	870 60	20	909 25(3) HPB	33	Polistar Weiß 100 g	64		
184 p10 HPC	56	193 p10 HPB	57	214 20 HPB	48	254 25 HPC	42	283 22 UM	38	360 22 HPB	62	410 22 RED	31	654 40x07 H	68	873 125x24 K	26	909 25 R/4	33	Polistar Weiß 300 g	64		
184 p11 HP	56	193 p10 HPC	57	214 20 HPC	48	254 25 RED	42	283 22 UMC	38	360 22 HPC	62	410 22 UM	31	654 40x10 H	29	873 125x30 K	26	909 25 R/48	33	Schutzkappe	66		
184 p11 HPB	56	193 p11 HP	57	214 20 R	49	254 25 UM	42	283 g6 HP	54	360 p8 HP	62	410 25 HP	30	661 4"x50 H	29	876 25g R	26	909 25(3) HP	33	SE 1C	9		
184 p11 HPC	56	193 p12 HP	57	214 20 HPC	49	254 51	42	283 g6 UM	54	360 p8 HPB	62	410 25 HPB	30	661 4"x50 HG	29	901 19 HPB	32	909 25(3) HPB	33	SE 2B	10		
184 p7 HP	56	193 p12 HPB	57	215 17 HP	49	255 110 VL/2	43	283 s6 HP	53	360 s6 HPC	62	410 25 HPC	30	661 6"x50 H	29	901 19 HP	32	9245	17	SE 2C	10		
184 p7 HPB	56	193 p12 HPC	57	215 17 HPB	49	255 110 VL/4	43	283 s6 HPB	53	360 s6 HP	62	410 42	31	661 6"x50 HG	29	901 19 R/4	32	9255	17	SE 6C	9		
184 p7 HPC	56	193 p13 HP	57	215 17 HPC	49	255 25 HP	20	283 s6 HPC	53	360 s6 HPB	62	410 51	31	682 00	67	901 19 R/48	32	9280	17	SM 5 HP	66		
184 p8 HP	56	193 p13 HPB	57	216 8 HP	49	255 25 HPB	23	283 s6 UM	53	360 s6 HPC	62	410 51	31	682 01	67	901 19 R/48	32	AcryPol Set	72	SM 5 HPB	66		
184 p8 HPB	56	193 p13 HPC	57	216 8 HPB	49	255 25 HPC	23	284 16 HP	38	362 4 HP	63	410 HP	30	682 22 HP	37	901 25 R/4	33	AS 400	70	SM 8 HP	66		
184 s5 HP	53	193 p6 UM	57	216 8 HPC	49	255 25 RED	23	284 16 HPB	38	367 4 HP	63	410 p8 HPB	30	682 22 HPC	37	901 25(3) HP	33	AS 450	70	SM MiMa 8 HP	66		
184 s5 UM	53	193 p6 UML	57	220 6 HP	49	255 25 UM	23	284 16 HPC	38	372 4 HP	63	410 p8 HPC	30	682 22 HPC	37	901 25(3) HPB	33	AS 500	70	SMC 5 HP	66		
184 s6 HP	53	193 p7 HP	57	220 6 HPB	49	255 30/3 HPB	42	284 16 RED	38	372 4 HPB	63	410 s6 HP	30	682 22 RED	37	901 51x4	34	AS 550	70	SMC 5 HPC	66		
184 s6 HPB	53	193 p7 HPB	57	220 6 HPC	49	255 40/3 HPB	42	284 16 UM	38	372 6 HP	63	410 s6 HPB	30	682 22 UM	37	901 51x4 HP6	34	AS 600	70	SP 3 HP	66		
184 s6 HPC	53	193 p7 HPC	57	222 12 HPB	48	255 80 VL/2	42	284 16 UMC	38	372 6 HPB	63	410 s6 HPC	30	682 51	21	901 76x4	34	AS 700	70	SP0	69		
184 s6 UM	53	193 p8 HP	57	222 12 HPC	48	255 80 VL/4	42	284 19 HP	38	374 15 HP	63	420 19 HP	30	682 51 HP6	21	901 76x4 HP6	34	ASTRO 7 100	41	SP02	69		
192 10 HP	58	193 p8 HPB	57	222 6 HP	48	256 25 HP	42	284 19 HPB	38	374 15 HPB	63	420 19 HPB	30	692 00	67	902 14 HP	32	ASTRO 7 102	41	Spannzange HP	70		
192 10 HPB	58	193 p8 HPS	57	222 6 HPB	48	256 25 HPB	43	284 19 HPC	38	374 15 R	63	420 19 HPC	30	692 01	67	902 14 HPB	32	ASTRO 7 114	41	Spannzange HPB	70		
192 10 PP	58	193 p9 HP	57	222 6 HPC	48	256 25 HPC	43	284 19 RED	38	375 22 HP	63	420 19 UM	31	692 p7 HPS	57	902 14 R/4	32	ASTRO 7 115	41	SV 5 HP	66		
192 10 PPB	58	193 s5 HP	53	222 8 HP	48	256 25 RED	23	284 19 UM	38	375 22 R	63	420 22 HP	30	7380	16	902 14 R/48	32	ASTRO 9 100	41	ThermoPol Set	72		
192 12 HP	61	193 s5 HPB	53	222 8 HPB	49	256 25 UM	23	284 19 UMC	38	377 4 HP	63	420 22 HPB	30	7480	68	902 14 R/48	32	ASTRO 9 102	41	TK0	69		
192 12 UM	61	193 s5 UM	53	222 8 HPC	49	257 25 UM	23	284 22 HP	38	377 4 HPB	63	420 22 HPC	30	754 22x02 H	68	902 19 HP	32	ASTRO 9 114	41	TK00	69		
192 14 HP	61	193 s6 HP	53	223 12 HPB	48	257 25 RED	23	284 22 HPB	38	392 4 HP	63	420 22 RED	31	754 22x03 H	68	902 19 HPB	32	ASTRO 9 115	41	TK2	69		
192 14 HPB	61	193 s6 HPB	53	223 12 HPC	48	257 25 HP	42	284 22 HPC	38	392 4 HPB	63	420 22 UM	31	754 22x05 H	68	902 19 R/4	32	ASTRO 9 116	41	TK4	69		
192 14 UM	61	193 s6 HPC	53	224 20 HP	48	257 25 HPB	42	284 22 RED	38	392 6 HP	63	420 25 HP	30	754 25x02 H	68	902 19 R/48	32	CeroPol Set	72	TK6	69		
192 16 HP	37	193 s6 UM	53	224 20 HPC	48	257 25 HPC	42	284 22 UM	38	392 6 HPB	63												



HATHO GmbH

Gewerbepark Breisgau
Freiburger Straße 18
79427 Eschbach
Germany

Tel. +49 76 34 50 39-0
Fax. +49 76 34 50 39-22

info@hatho.de
www.hatho.de

