



Instrumente für die Allgemeinchirurgie, Ophthalmologie, Orthopädie und Mikrochirurgie, sowie HNO und Implantate

*Instruments for General Surgery, Ophtalmology, Orthopaedics and
Microsurgery, as well as ENT and Implants*





100% made in Germany - Schon lange produzieren wir in unserer Fertigung ausschließlich mit rostfreien europäischen Stählen in besonderer "medical"-Güte, um höchste Qualität unserer Instrumente zu gewährleisten.

Mehr Informationen auch auf www.stoerk-instrumente.de

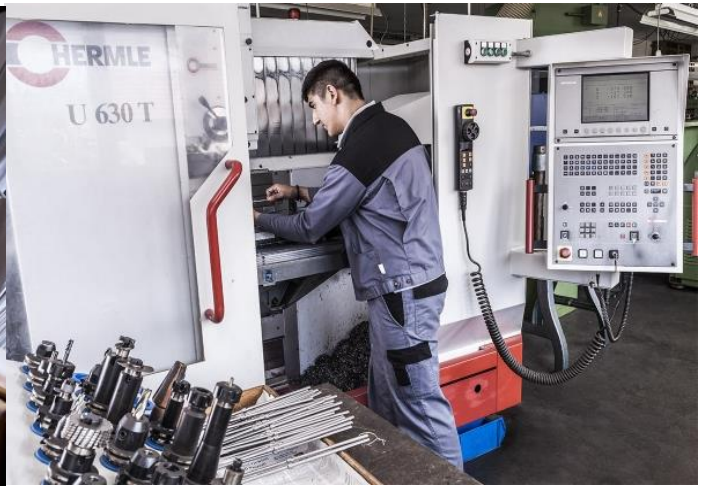

Funktionalität und Ästhetik

Unsere Anforderungen im Herstellungsprozess sind hoch. Wir fertigen mit geringsten Toleranzen, und jedes unserer Instrumente ist ein handgefertigtes Einzelstück – hergestellt mit Liebe zum Detail und mit dem Fokus auf der Verbindung von perfekter Funktionalität und Haptik sowie einer Ästhetik, die das Arbeiten damit zu einem einzigartigen Erlebnis macht.





In der Allgemeinchirurgie fertigen wir in folgenden Bereichen:

Wundhaken, Bauchspatel, Darmspatel, Kieferchirurgie, Gesichtschirurgie, Unterbindungsnadeln, Führungshohlsonden, Fadenfänger, Hauthaken, Hauthäkchen

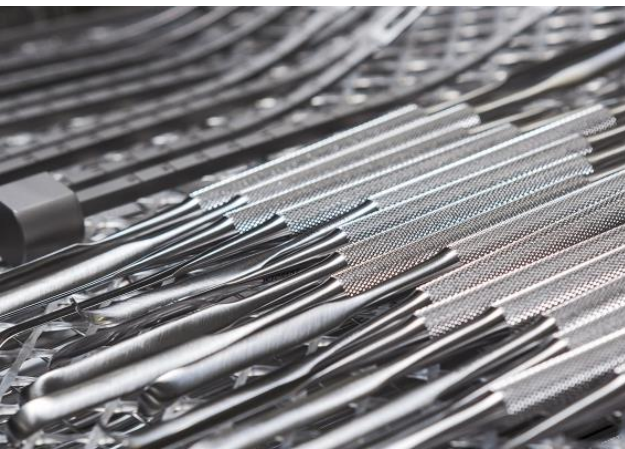



Klaus Störk | Geschäftsführer



Andreas Störk | Geschäftsführer

"Wir sind sehr stolz darauf, dass unsere Mitarbeiter nicht nur Arbeitnehmer sind, sondern sich auch für ihr Unternehmen verantwortlich fühlen."

st störk
INSTRUMENTE

Engener Straße 29
78576 Emmingen-Liptingen

Fon: +49 7465 / 825
Fax: +49 7465 / 2216

Mail: info@stoerk-instrumente.de



Hauptkatalog

Version 2

	Seite
Wundhaken	1 - 32
Bauch- und Darmspatel	33
Kiefer- und Gesichtschirurgie	34 - 41
Unterbindungsнадeln, Führungshohlsonden, Fadenfänger	42 - 53
Stößel, Flachmeißel, Hohlmeißel, Raspeln	54 - 57
Scharfe Löffel, Raspatorien, Elevatorien, Knochenheber, Dissektoren, Nervhaken	58 - 82
Gallensteinlöffel, Blasenspatel, Scheidenspekula, Fistelhaken	83 - 88
Ophthalmologie	89 - 93
Otologie	94 - 98
Rhinologie, Zungenspatel, Tonsillenelevatorien, -haken	99 - 108

A = Tiefe
Depth
Profondeur
Profundidad

B = Breite
Width
Largeur
Ancho

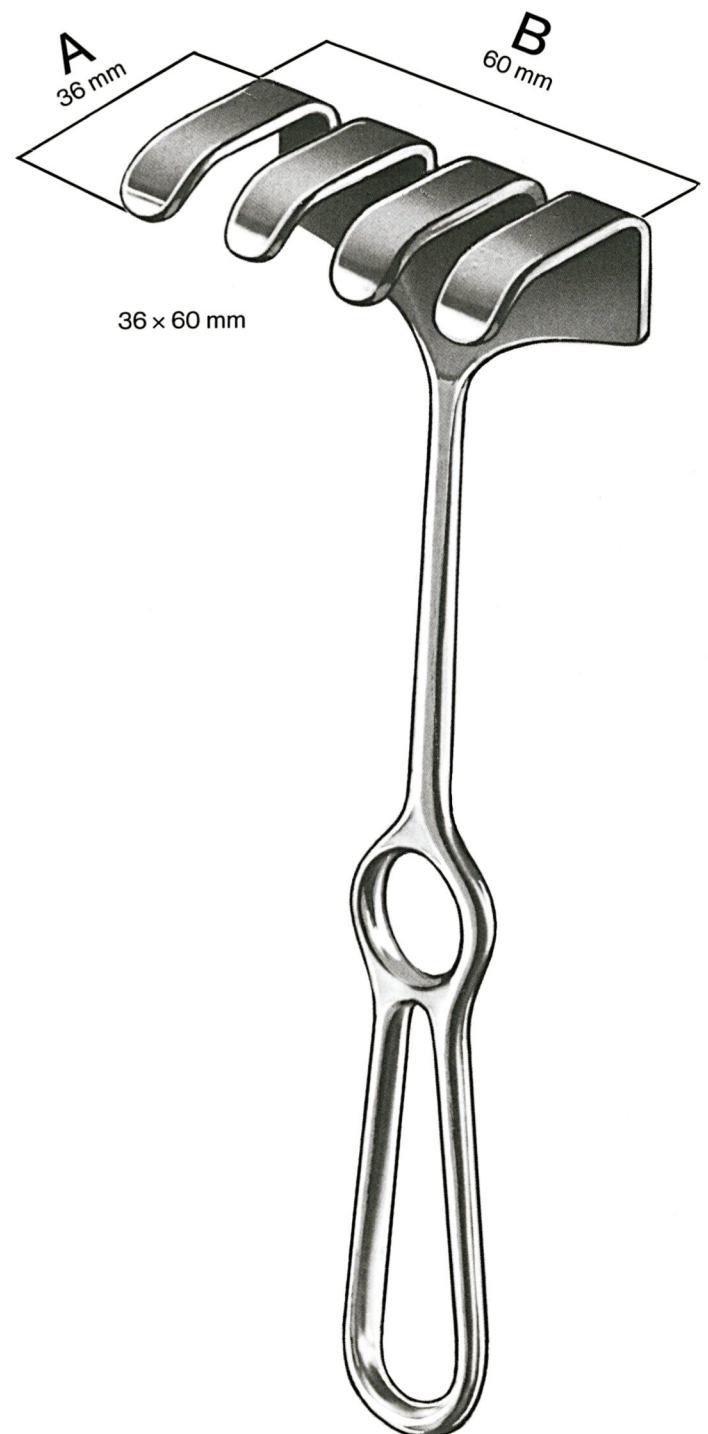

Wundhaken
Retractors
Ecarteurs
Separadores

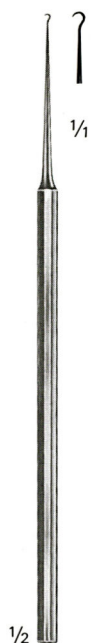

Niro
02.020-01
 17 cm/6 3/4"

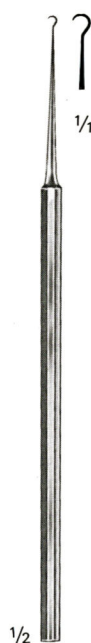

Niro
02.020-02
 17 cm/6 3/4"

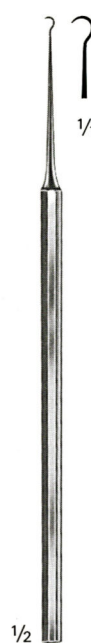

Niro
02.020-03
 17 cm/6 3/4"

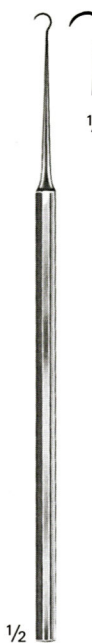

Niro
02.020-04
 17 cm/6 3/4"

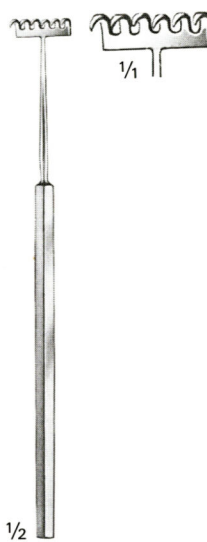

02.021-13
 13,5 cm/5 1/4"

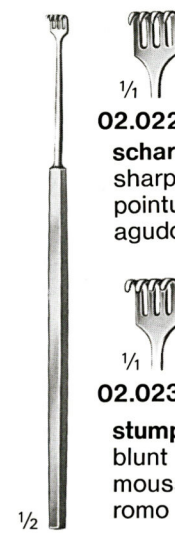

Blair
02.022-13–02.023-13
 13,5 cm/5 1/4"

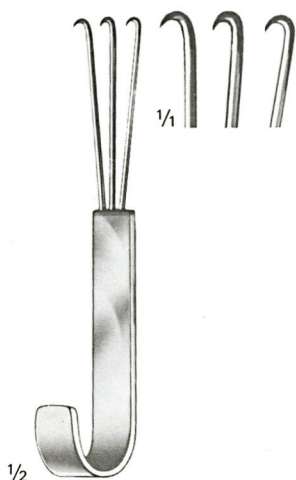

02.024-12
 12 cm/4 3/4"

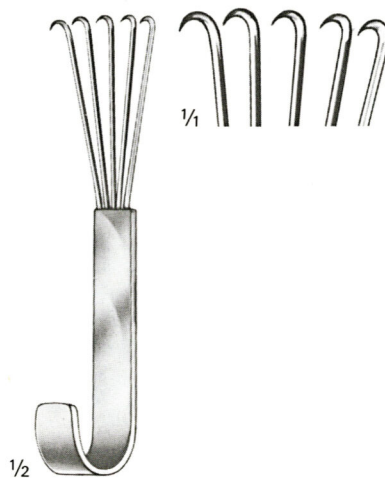

02.025-12
 12 cm/4 3/4"

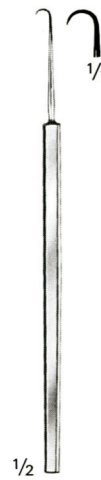

O'Conner
50.479-12
 12 cm/4 3/4"



Cushing
02.041-14
 14 cm/5 1/2"



Cloward
02.042-16
 16,5 cm/6 1/2"

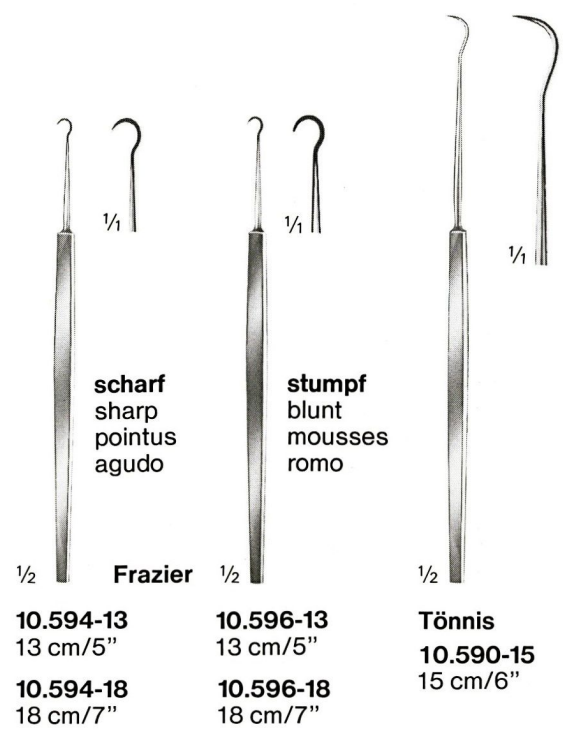
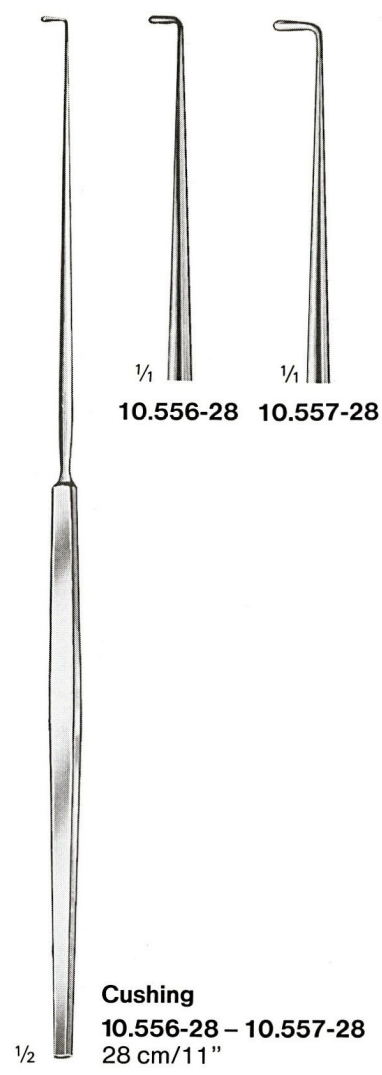
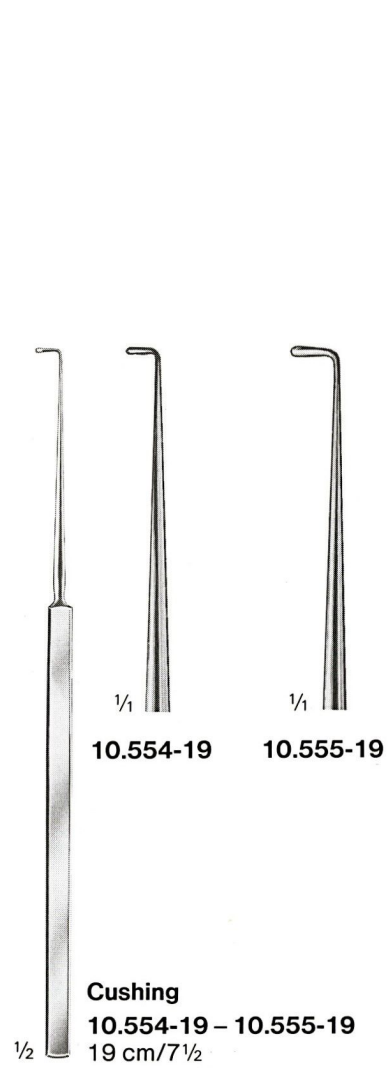
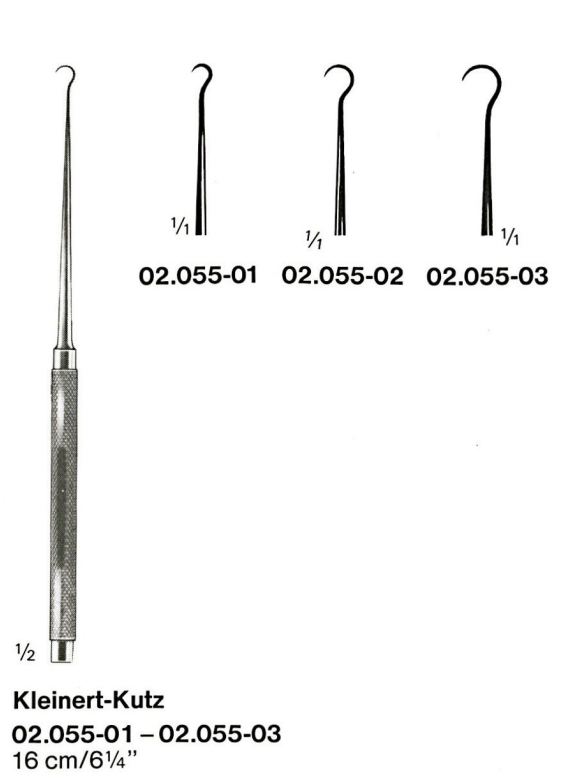
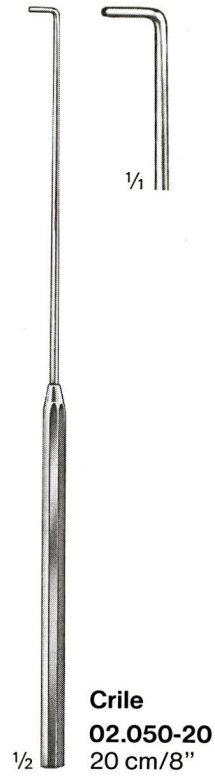
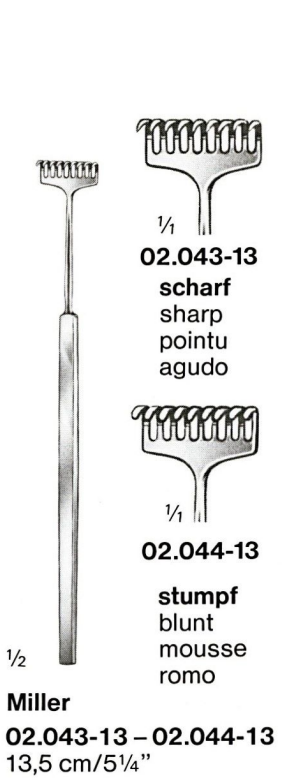

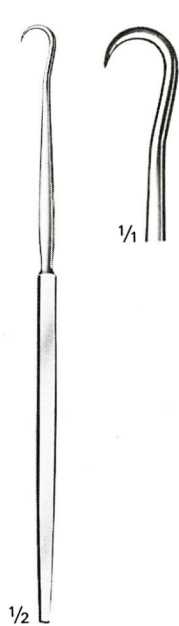

Iterson
02.056-16
 16 cm/6 1/4"



Iterson
02.057-16
 16 cm/6 1/4"



Rose
02.060-13
 13 cm/5"

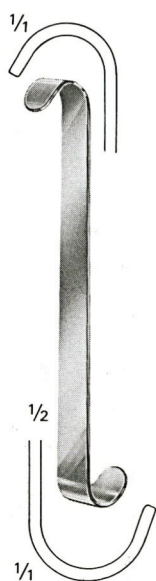

Luer
02.061-11
 11 cm/4 1/2"



Jackson
02.062-13
 13 cm/5"



Jackson
02.062-15
 15 cm/6"



News
02.063-15
 15 cm/6"

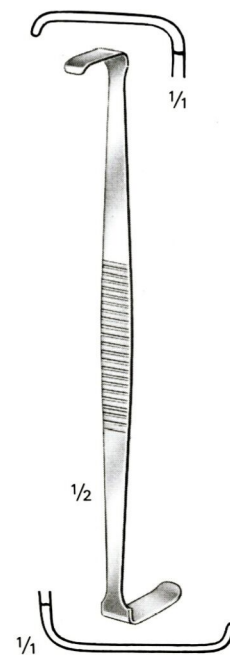

House
02.064-15
 15 cm/6"

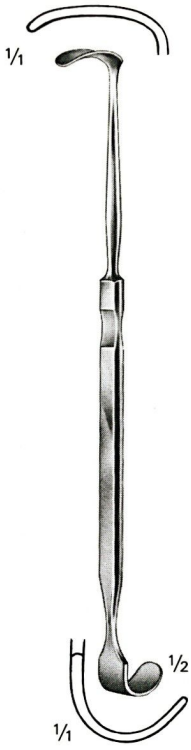

Lukens
02.065-17
17 cm/6 1/4"



Jackson
02.066-17
17 cm/6 1/4"

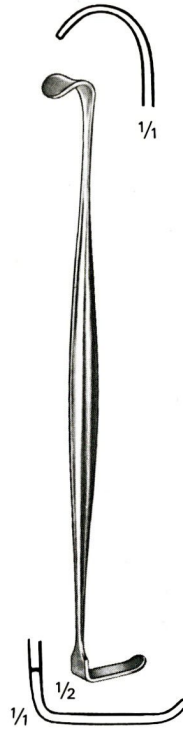

Cope
02.067-18
18 cm/7"



Schoenborn
02.068-21
21 cm/8 1/4"

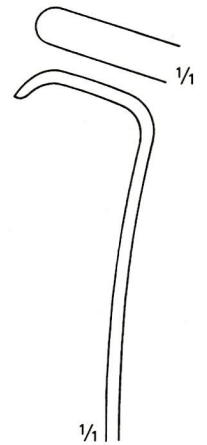

Kilner
02.069-15
15 cm/6"

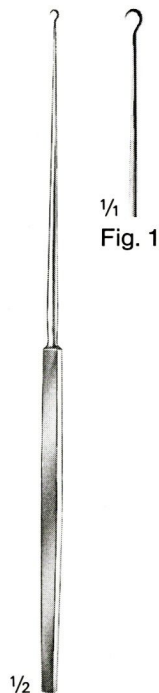

Gillies
10.620-01
18 cm/7"

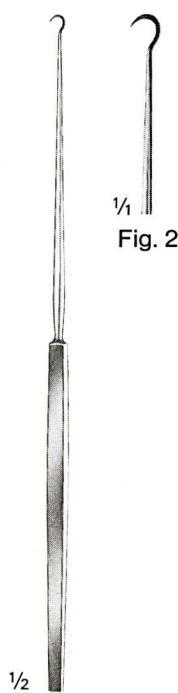

Gillies
10.622-02
18 cm/7"



Gillies
02.073-18
18 cm/7"

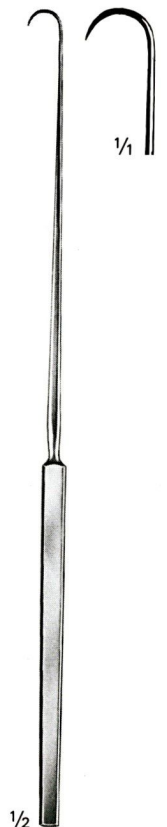

Sachs
02.074-21
21 cm/8 1/4"

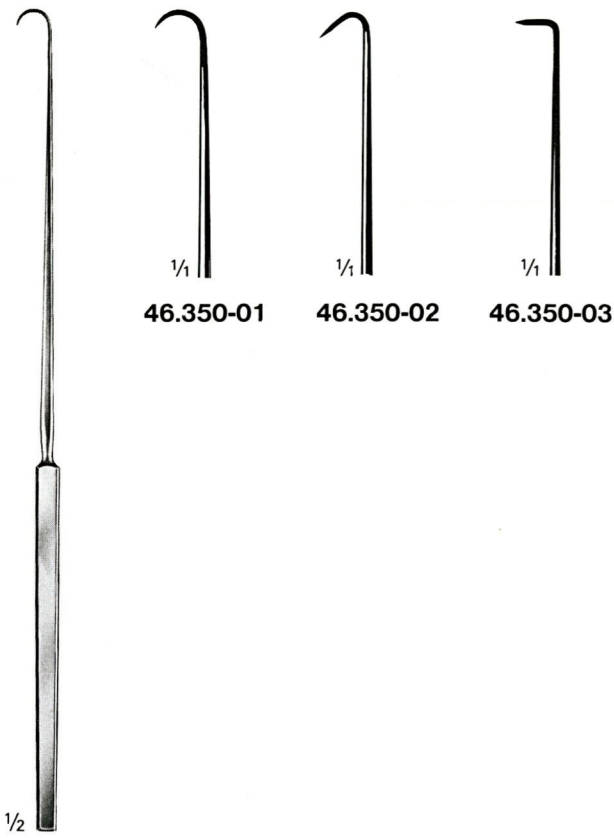

Emmet
 46.350-01 – 46.350-03
 22 cm/8 3/4"

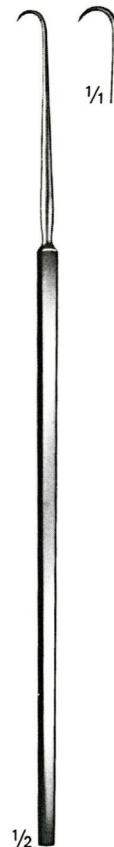

Simon
 46.361-22
 22 cm/8 3/4"

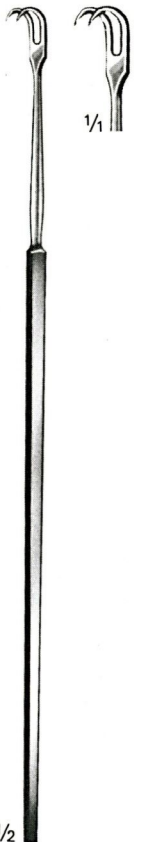

Simon
 46.362-22
 22 cm/8 3/4"

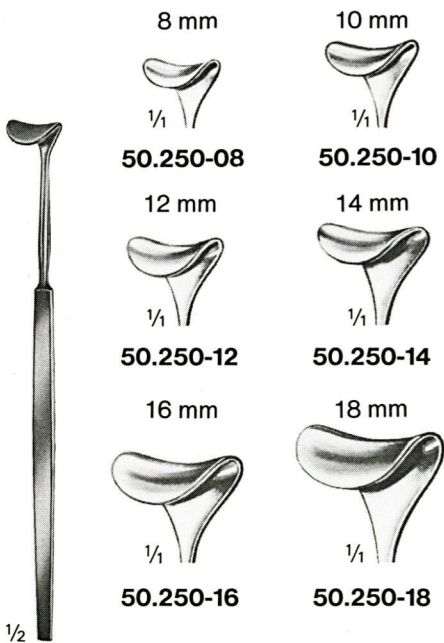

Desmarres
 50.250-08 – 50.250-18
 13 cm/5"



Graefe
 50.475-12 – 50.476-12
 12 cm/4 3/4"



Guthrie
 50.485-12
 12 cm/4 3/4"

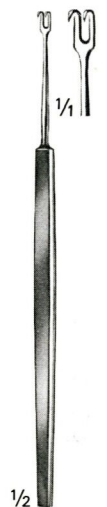

Guthrie
 50.486-13
 13 cm/5"

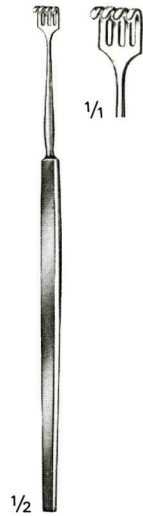

Knapp
50.491-13
13 cm/5"

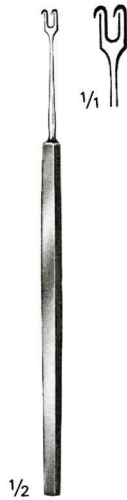

Rollet
50.492-12
12,5 cm/4 3/4"

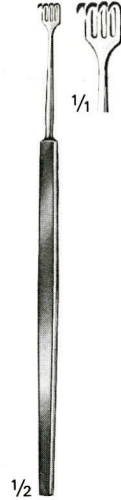

Rollet
50.492-13
13,5 cm/5"

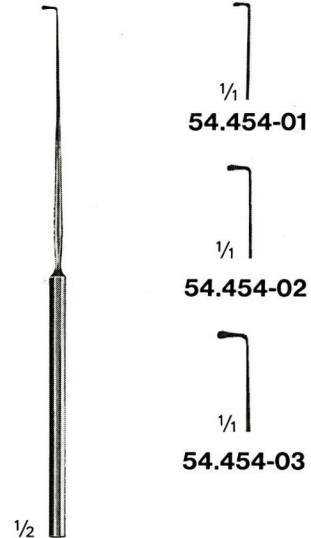

Lucae
54.454-01 – 54.454-03
14 cm/5 1/2"

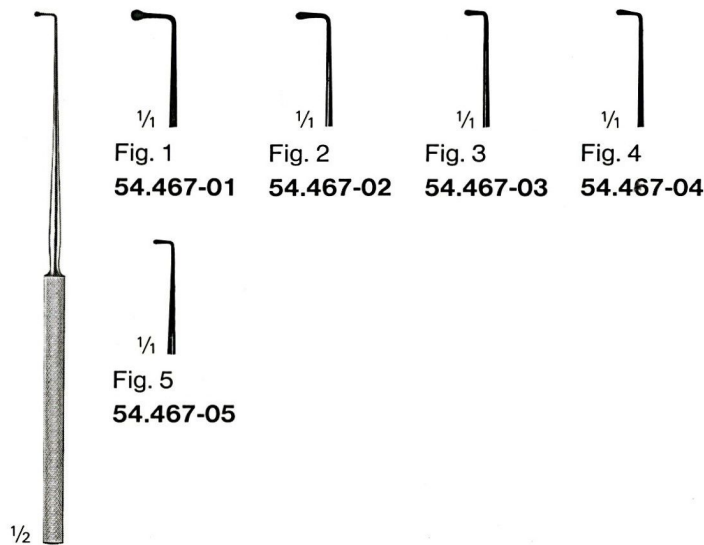

Wagener
54.467-01 – 54.467-05
14 cm/5 1/2"

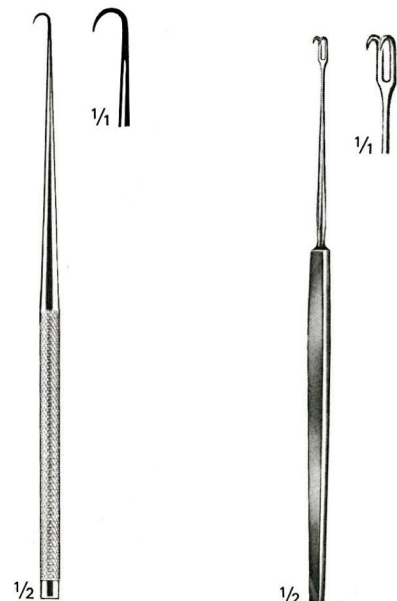

Joseph
56.392-15
15 cm/6"

Freer
56.401-15
15 cm/6"

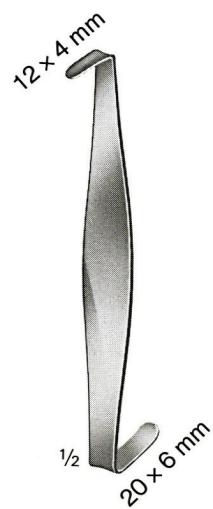
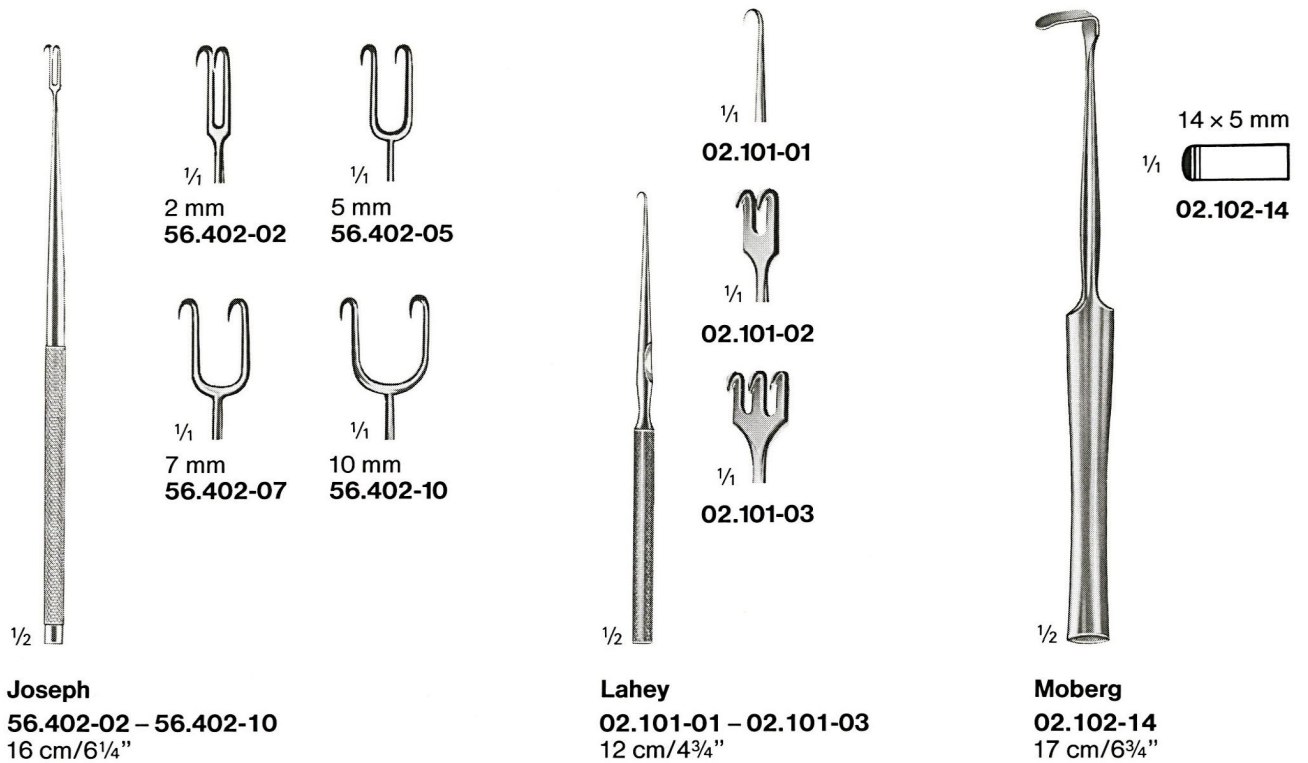

Crile
 02.104-11
 11 cm/4¾"

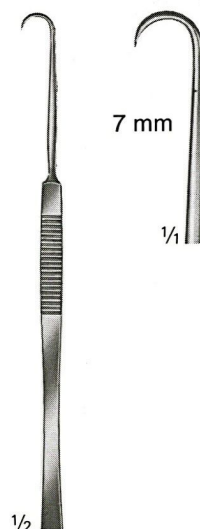

Bergmann
 02.105-14
 14 cm/5½"



Graefe
02.201-01 – 02.201-02
16 cm/6¼"



02.201-01

scharf
sharp
pointu
agudo



02.201-02

stumpf
blunt
mousse
romo



O'Connor
02.207-16
16 cm/6¼"



02.204-01 – 02.204-04
16 cm/6¼"



02.204-01

02.204-03



02.204-02

02.204-04



Guthrie
02.208-01 – 02.208-02
16 cm/6¼"



02.208-01

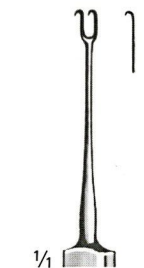

02.208-02

flexibel
 flexible
 flexibles
 flexible

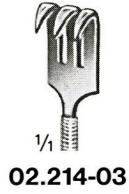
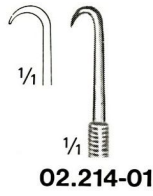

scharf
 sharp
 pointus
 agudo

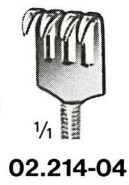

stumpf
 blunt
 mousses
 romo

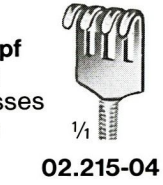
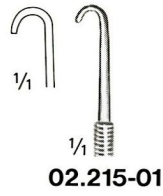

02.214-01 – 02.215-04
 16 cm/6³/₄"



02.224-01

scharf
 sharp
 pointus
 agudo

02.224-01
 16 cm/6³/₄"



02.228-04
scharf
 sharp
 pointu
 agudo

02.228-04
 16 cm/6³/₄"

10 x 10 mm

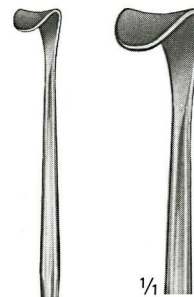

1/2

Cushing-Kocher
02.230-18
 18 cm/7"



1/2

Desmarres

02.232-08 – 02.232-18
16 cm/6 1/4"

8 mm



1/1

02.232-08

12 mm



1/1

02.232-12

16 mm

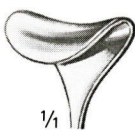

1/1

02.232-16

10 mm



1/1

02.232-10

14 mm



1/1

02.232-14

18 mm

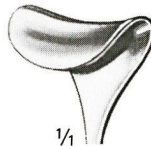

1/1

02.232-18



1/2

Mini-Langenbeck

02.242-10 – 02.242-22
16 cm/6 1/4"

10 x 6 mm

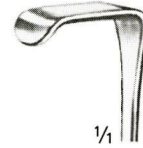

1/1

02.242-10

20 x 6 mm



1/1

02.242-20

17 x 5 mm

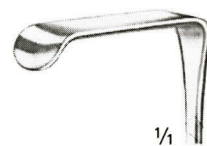

1/1

02.242-17

22 x 8 mm



1/1

02.242-22



1/2

scharf
sharp
pointus
agudo

02.250-01 – 02.250-04
16 cm/6 1/4"



1/1

02.250-01



1/1

02.250-02



1/1

02.250-04



1/1



1/2

stumpf
blunt
mousses
romo

02.251-01 – 02.252-04
16 cm/6 1/4"

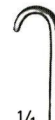

1/1

02.251-01



1/1

02.251-02



1/1

02.251-04



1/1

02.252-01



1/1

02.252-02



1/1

02.252-04

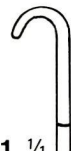

1/1

halbscharf
semi-sharp
semi-pointu
semiagudo

flexibel
 flexible
 flexibles
 flexible



02.260-01 – 02.261-04
 16 cm/6 1/4"

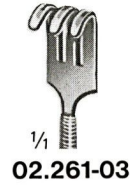
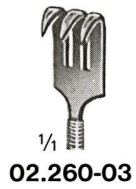
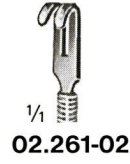
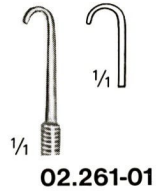

scharf
 sharp
 pointus
 agudo

stumpf
 blunt
 mousses
 romo

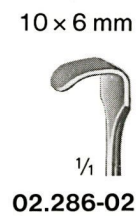
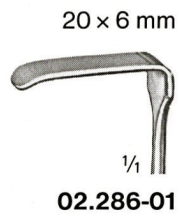

Senn-Green
02.286-01 – 02.286-02
 16 cm/6 1/4"

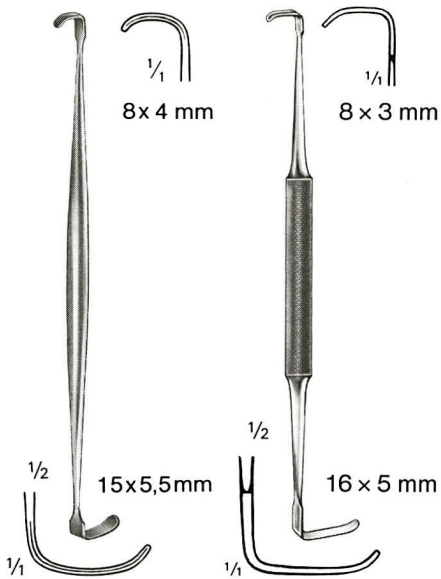

Ragnell-Davis
02.287-14
14 cm/5½"

Ragnell
02.288-14
15 cm/6"

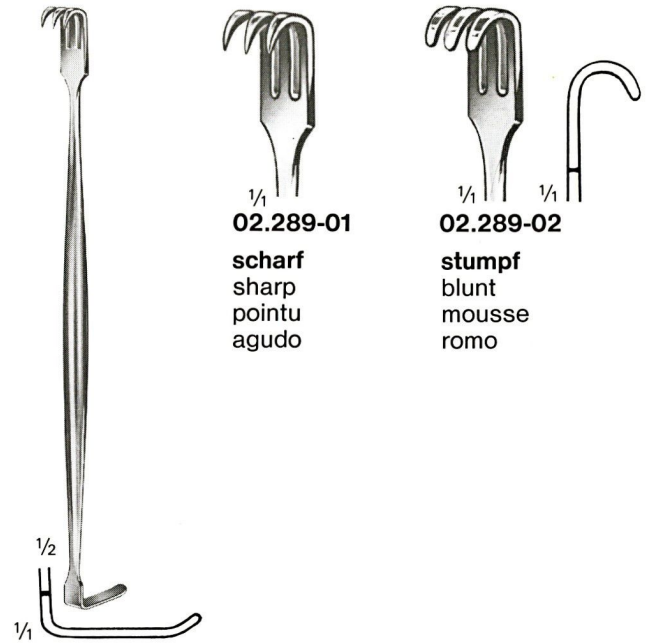

Senn-Miller
02.289-01 – 02.289-02
16 cm/6¼"

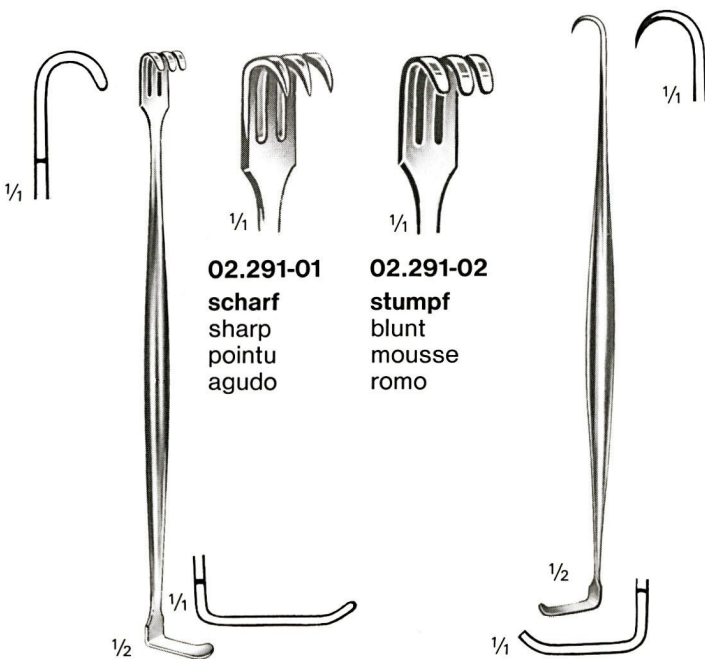

Mathieu
02.291-01 – 02.291-02
16 cm/6¼"

Meyerding
02.292-16
16 cm/6¼"

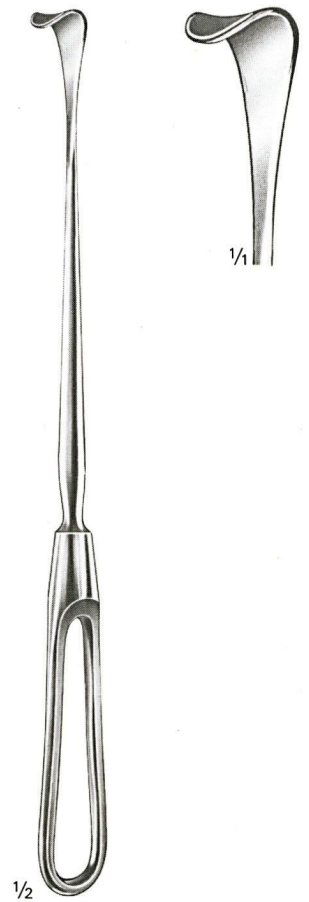

Cushing
02.294-21
21,5 cm/8½"

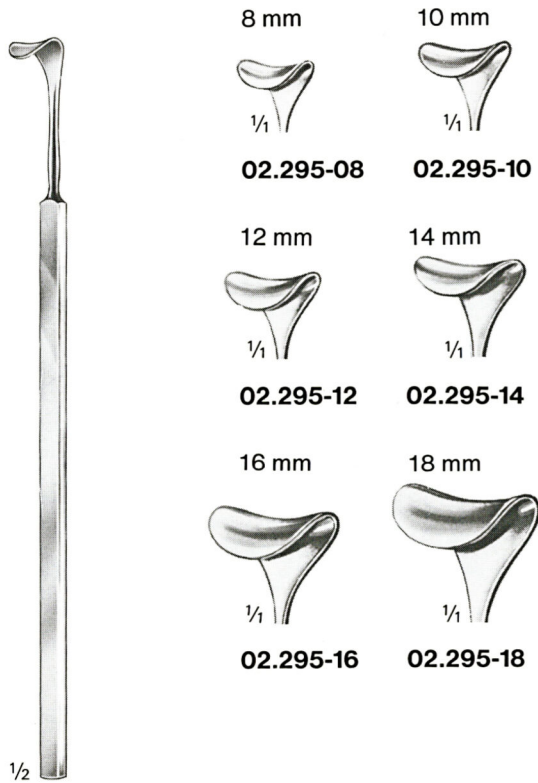

Cushing
02.295-08 – 02.295-18
 20 cm/8"

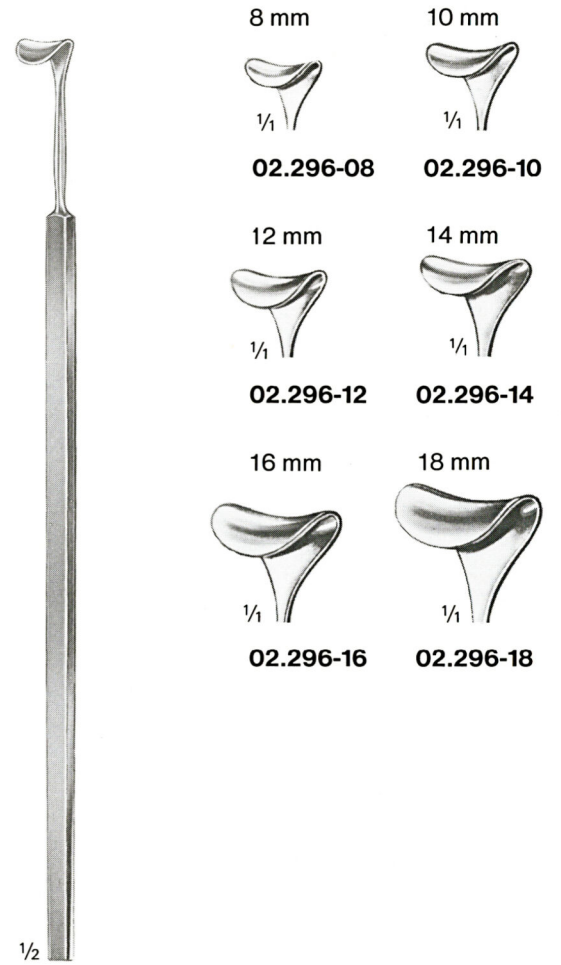

Cushing
02.296-08 – 02.296-18
 24 cm/9 1/2"

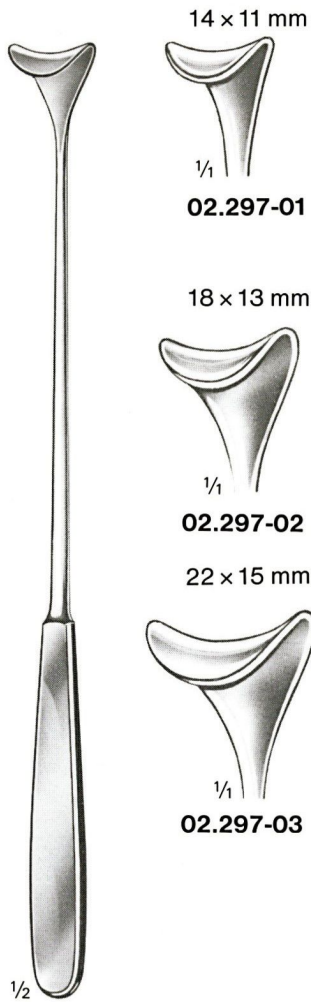

Cushing
02.297-01 – 02.297-03
25 cm/10"

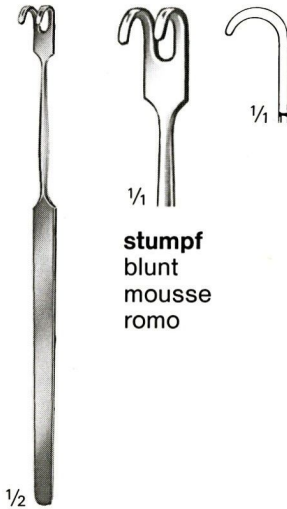

02.306-02
13,5 cm/5 1/4"

stumpf
blunt
mousse
romo

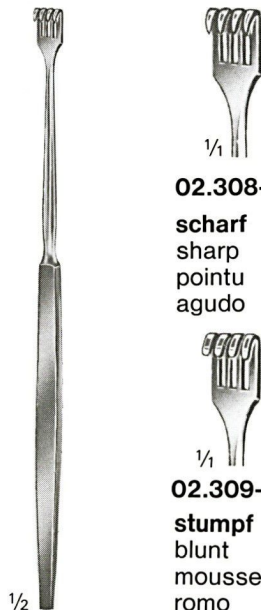

02.308-04 – 02.309-04
16 cm/6 1/4"

02.308-04

scharf
sharp
pointu
agudo

02.309-04

stumpf
blunt
mousse
romo

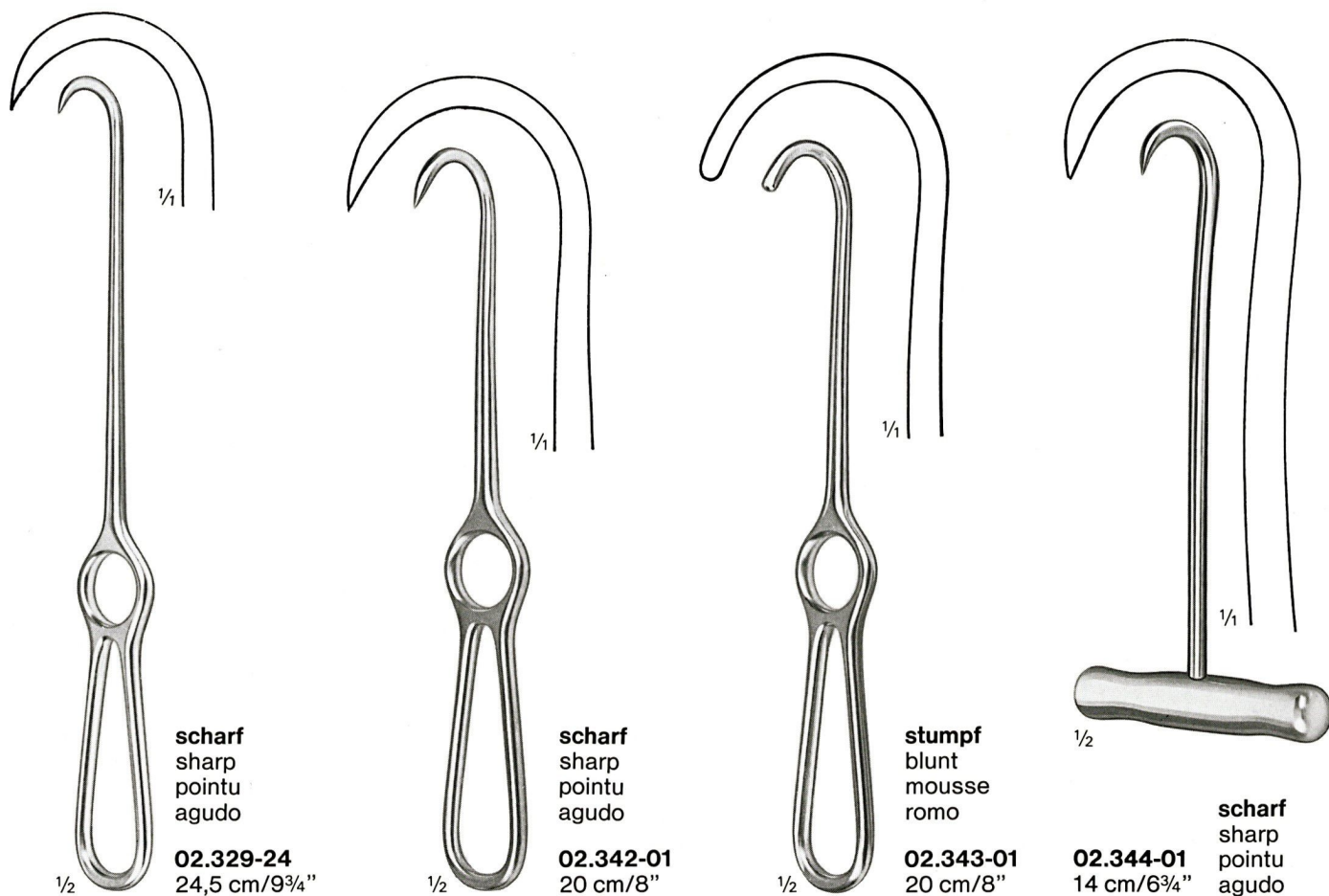
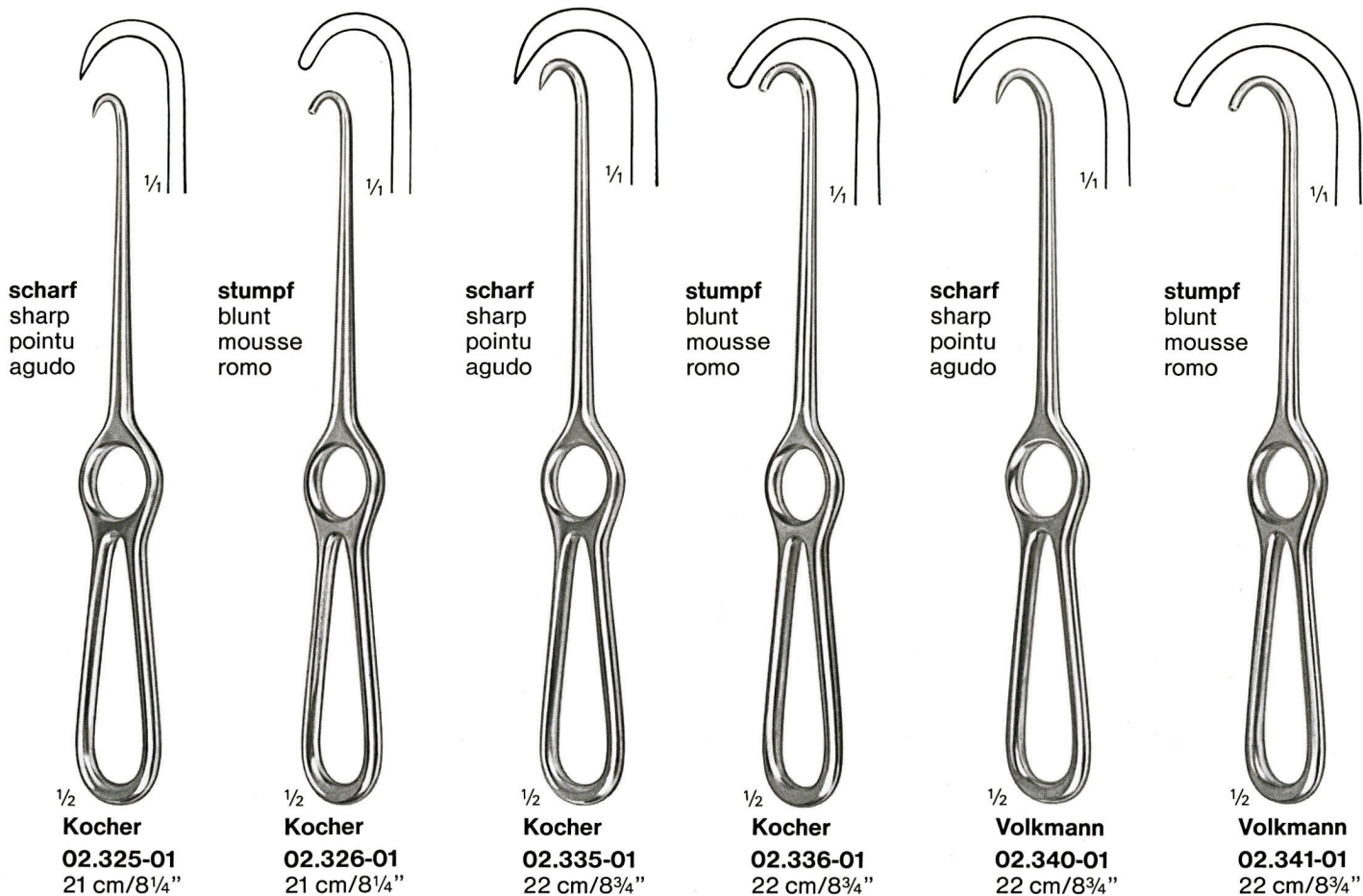

02.377-55 55 x 20 mm

02.377-60 60 x 20 mm

02.377-63 63 x 20 mm

85 x 15 mm

Langenbeck
02.377-55 – 02.377-63
21 cm/8¼"

12 x 14 mm

Langenbeck
02.378-21
21,5 cm/8½"

Little
02.388-20
20 cm/8"

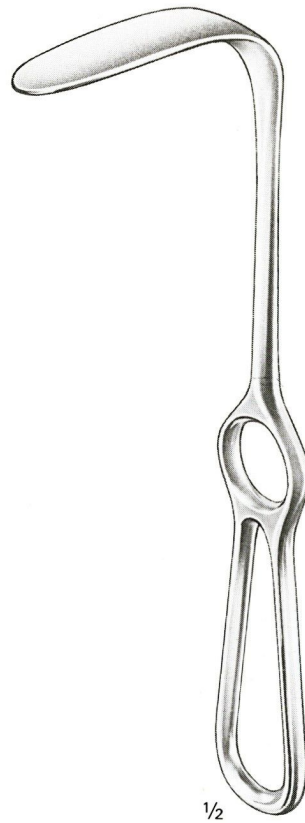

½

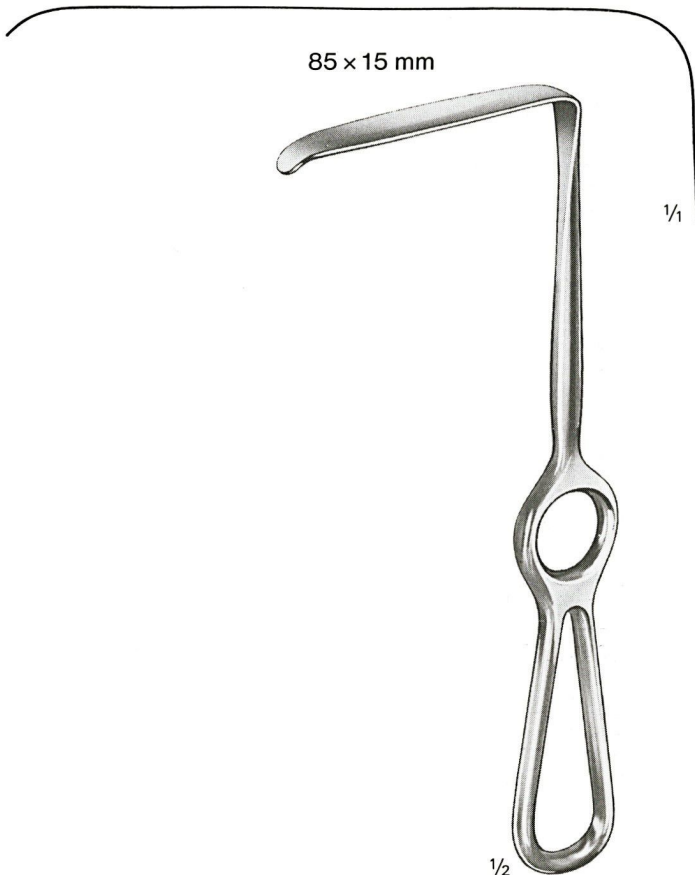

½

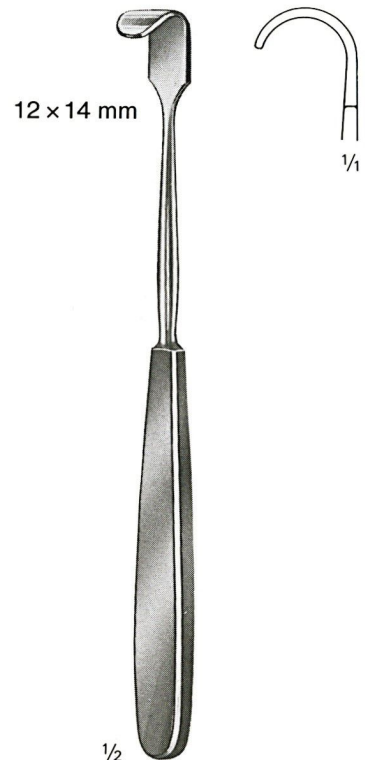

½

½

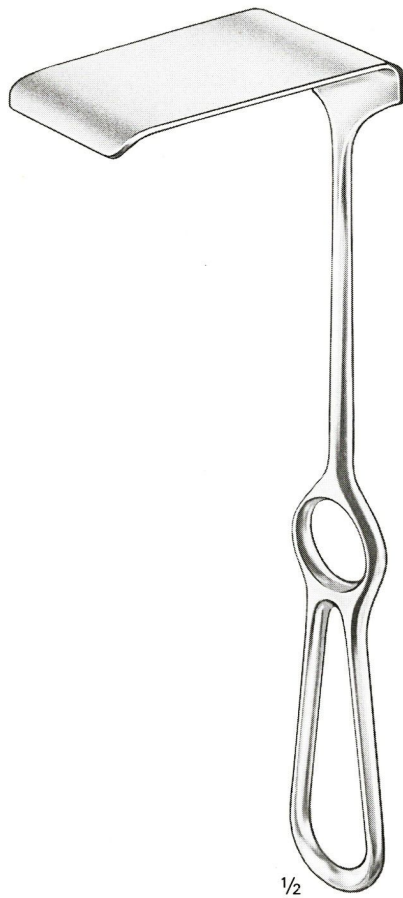

Kocher
02.389-01 – 02.389-05
23 cm/9"

40 × 18 mm

02.389-01

1/1

60 × 20 mm

02.389-02

1/1

60 × 25 mm

02.389-03

1/1

75 × 30 mm

02.389-04

1/1

75 × 40 mm

02.389-05

1/1

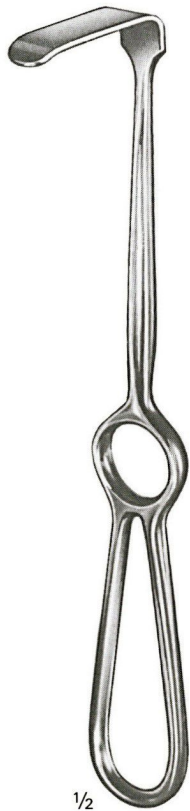

$\frac{1}{2}$
Kocher-Langenbeck
02.391-01 – 02.391-10
21,5 cm/8 $\frac{1}{2}$ "

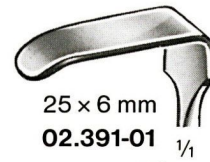

25 × 6 mm
02.391-01 $\frac{1}{4}$

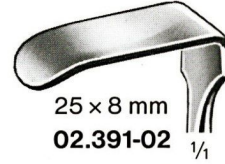

25 × 8 mm
02.391-02 $\frac{1}{4}$



35 × 8 mm
02.391-03 $\frac{1}{4}$

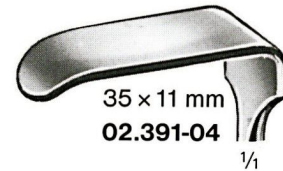

35 × 11 mm
02.391-04 $\frac{1}{4}$

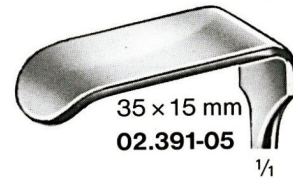

35 × 15 mm
02.391-05 $\frac{1}{4}$

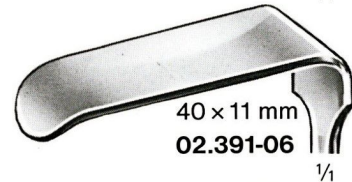

40 × 11 mm
02.391-06 $\frac{1}{4}$

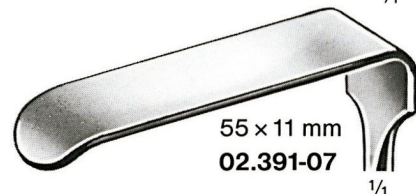

55 × 11 mm
02.391-07 $\frac{1}{4}$

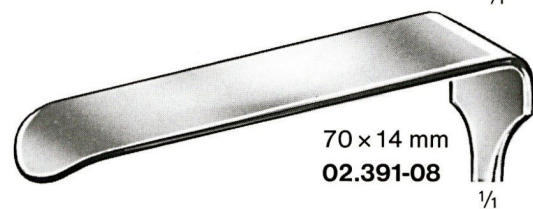

70 × 14 mm
02.391-08 $\frac{1}{4}$

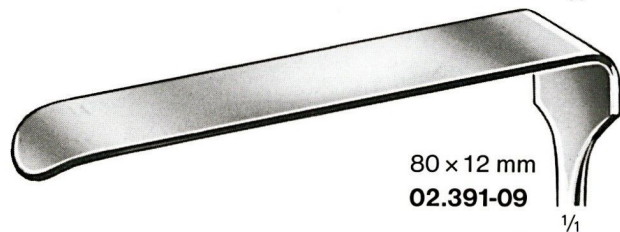

80 × 12 mm
02.391-09 $\frac{1}{4}$

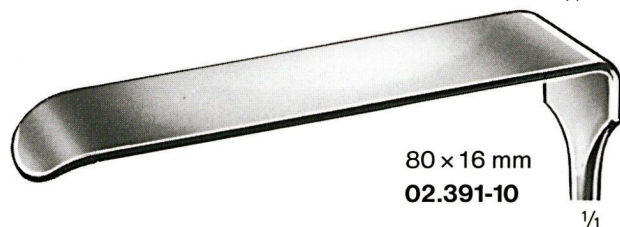

80 × 16 mm
02.391-10 $\frac{1}{4}$

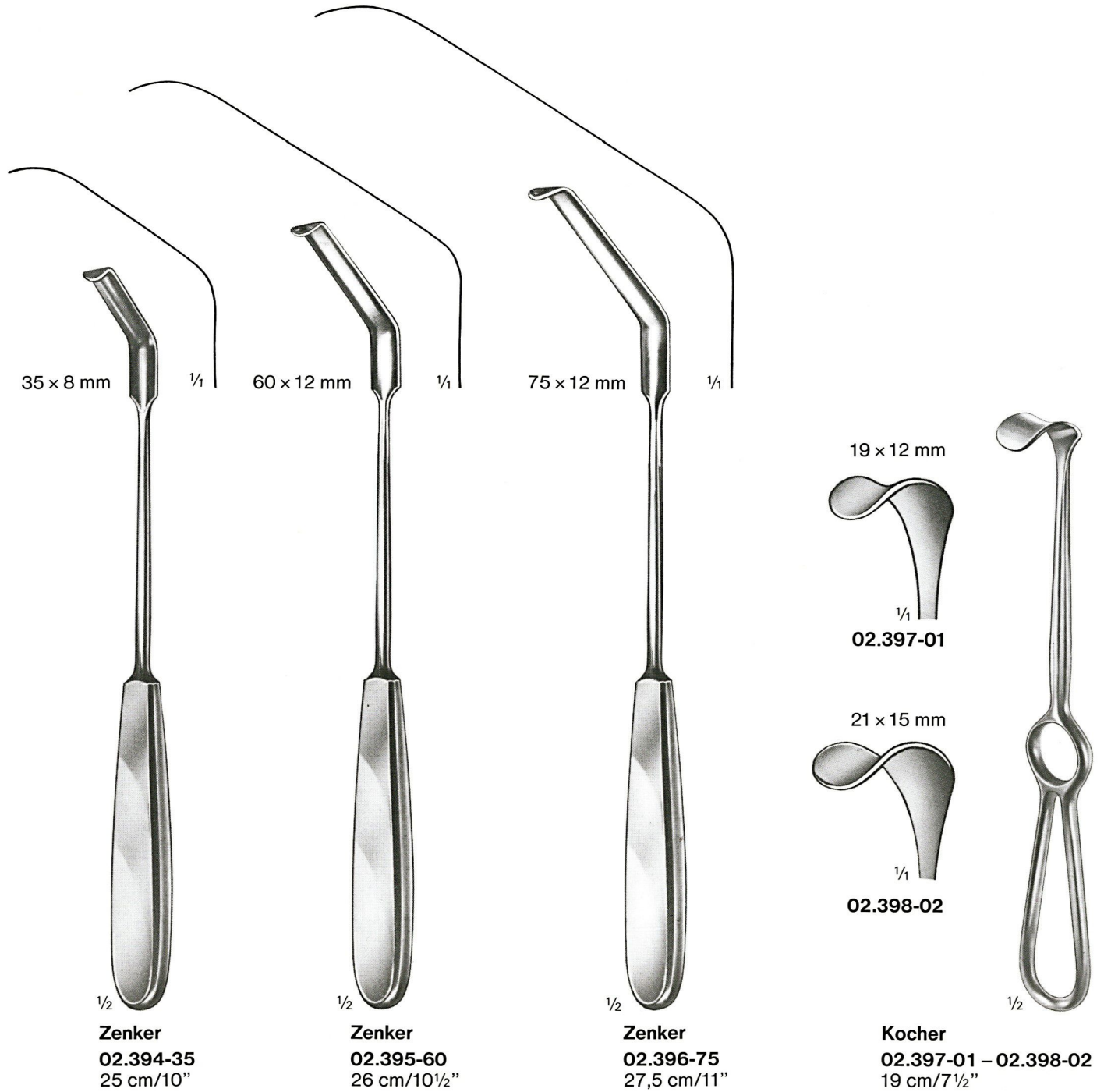

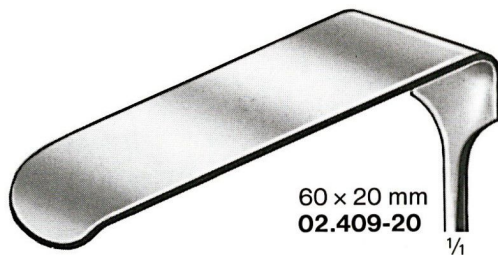
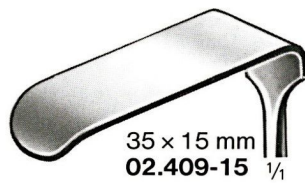
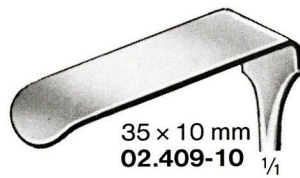
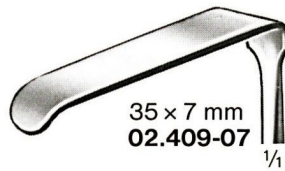

Langenbeck
02.409-07 – 02.409-20
21 cm/8 $\frac{1}{4}$ "

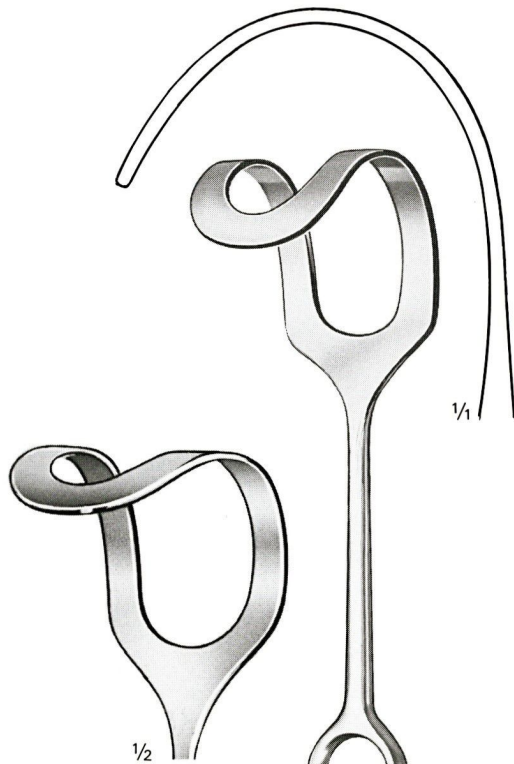

02.422-02
 45 x 50 mm



02.422-03
 55 x 70 mm

1/2

Middeldorpf
02.422-01
 45 x 45 mm
 25,5 cm/10"

1/2

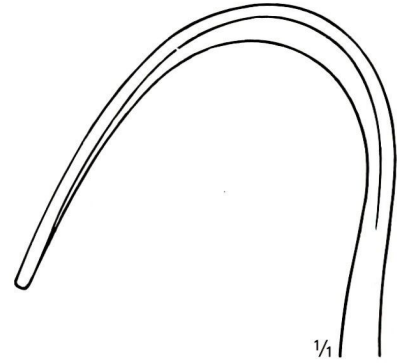

1/4

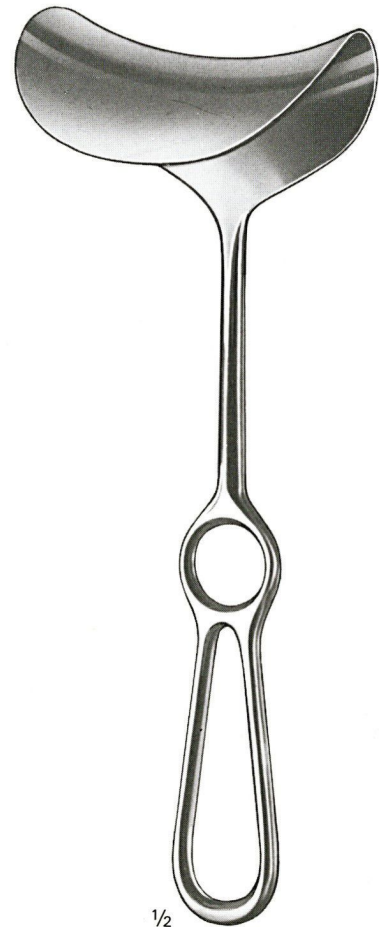

1/2

Fritsch
 24 cm/9 1/2"

- 02.424-01** Fig. 1 = 45 x 40 mm
- 02.424-02** Fig. 2 = 45 x 50 mm
- 02.424-03** Fig. 3 = 45 x 60 mm
- 02.424-04** Fig. 4 = 45 x 75 mm

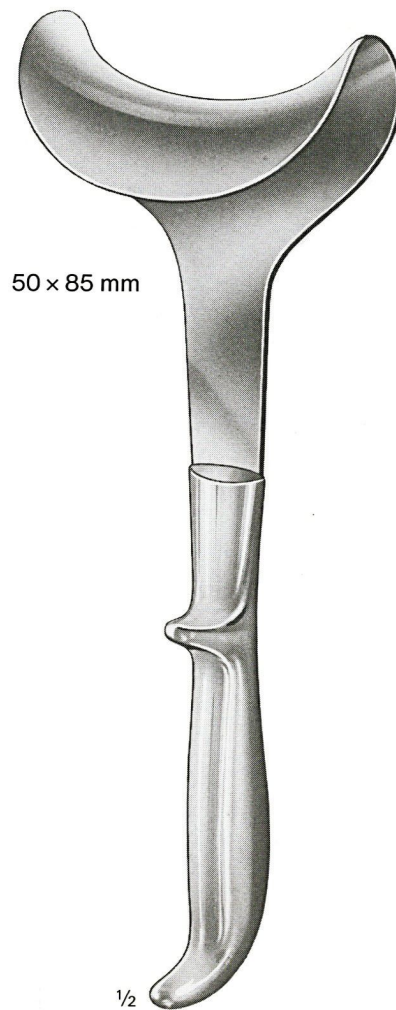

50 × 85 mm

1/2

Doyen
02.431-25
25 cm/10"

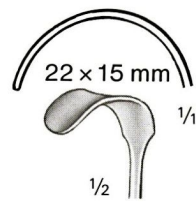

Kocher
02.438-15
28 cm/11"

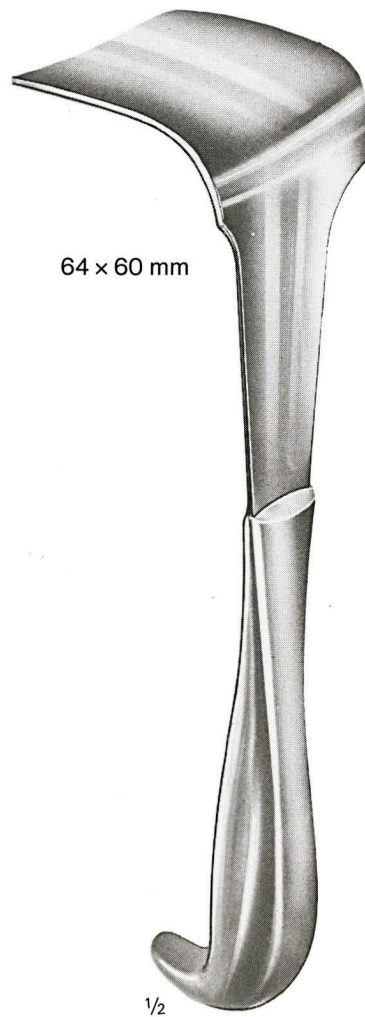

64 x 60 mm

1/2

Tuffier
02.439-23
23 cm/9"





02.458-02
55 x 23 mm

1/1

02.458-01
45 x 15 mm

1/1

1/2

Sauerbruch
02.458-01 – 02.458-02
22,5 cm/9"



Mikulicz
02.480-02 = 120 x 50 mm
02.480-03 = 155 x 50 mm
26 cm/10¹/₄"

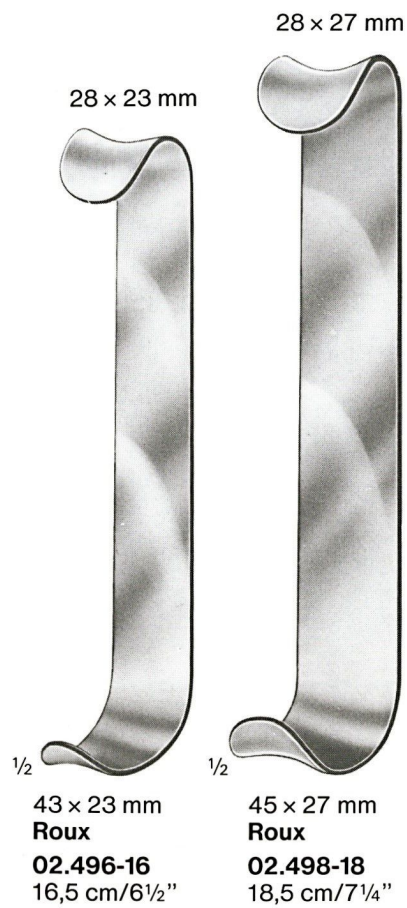
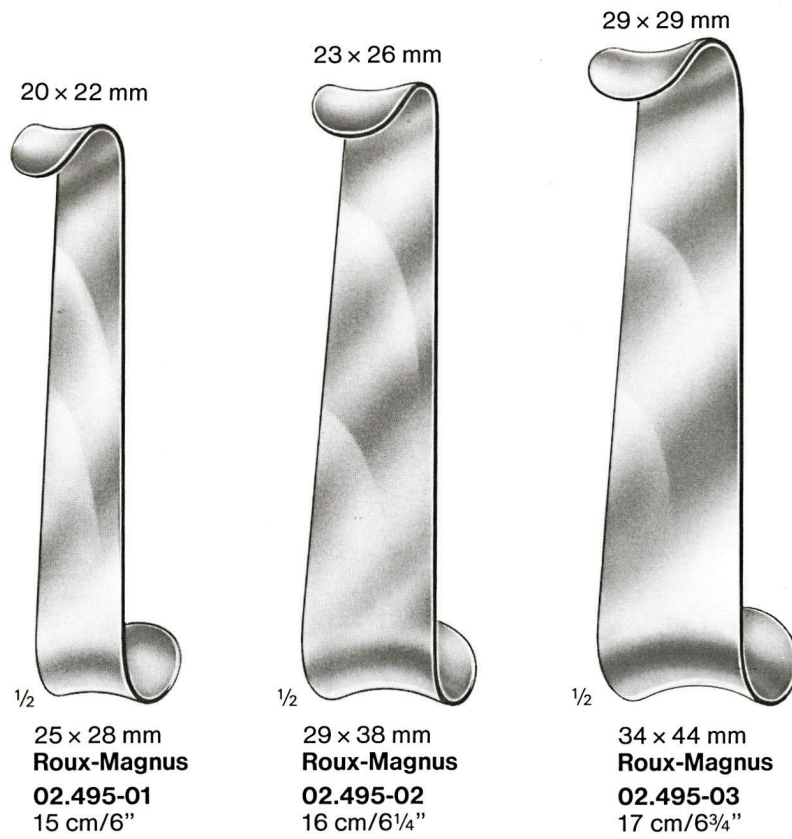

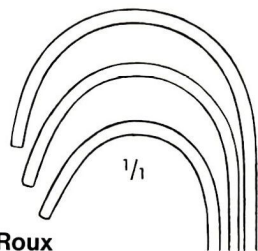

Roux

02.494-00

Satz – Set

Jeu – Juego

16,5 cm/6½"

02.494-01 20 × 22 mm

25 × 28 mm

02.494-02 23 × 26 mm

29 × 38 mm

02.494-03 29 × 29 mm

34 × 44 mm

29 mm
26 mm
22 mm

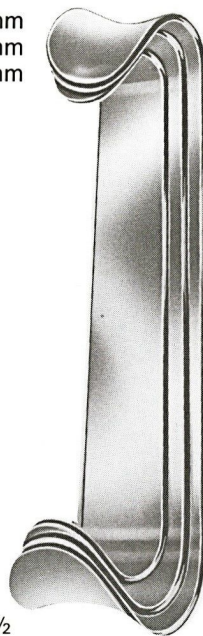

1/2

28 mm

38 mm

44 mm

15 × 15 mm

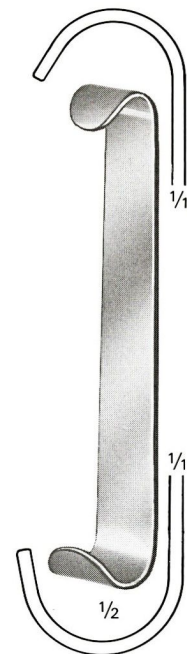

18 × 21 mm

Baby-Roux

02.511-13

13 cm/5¼"

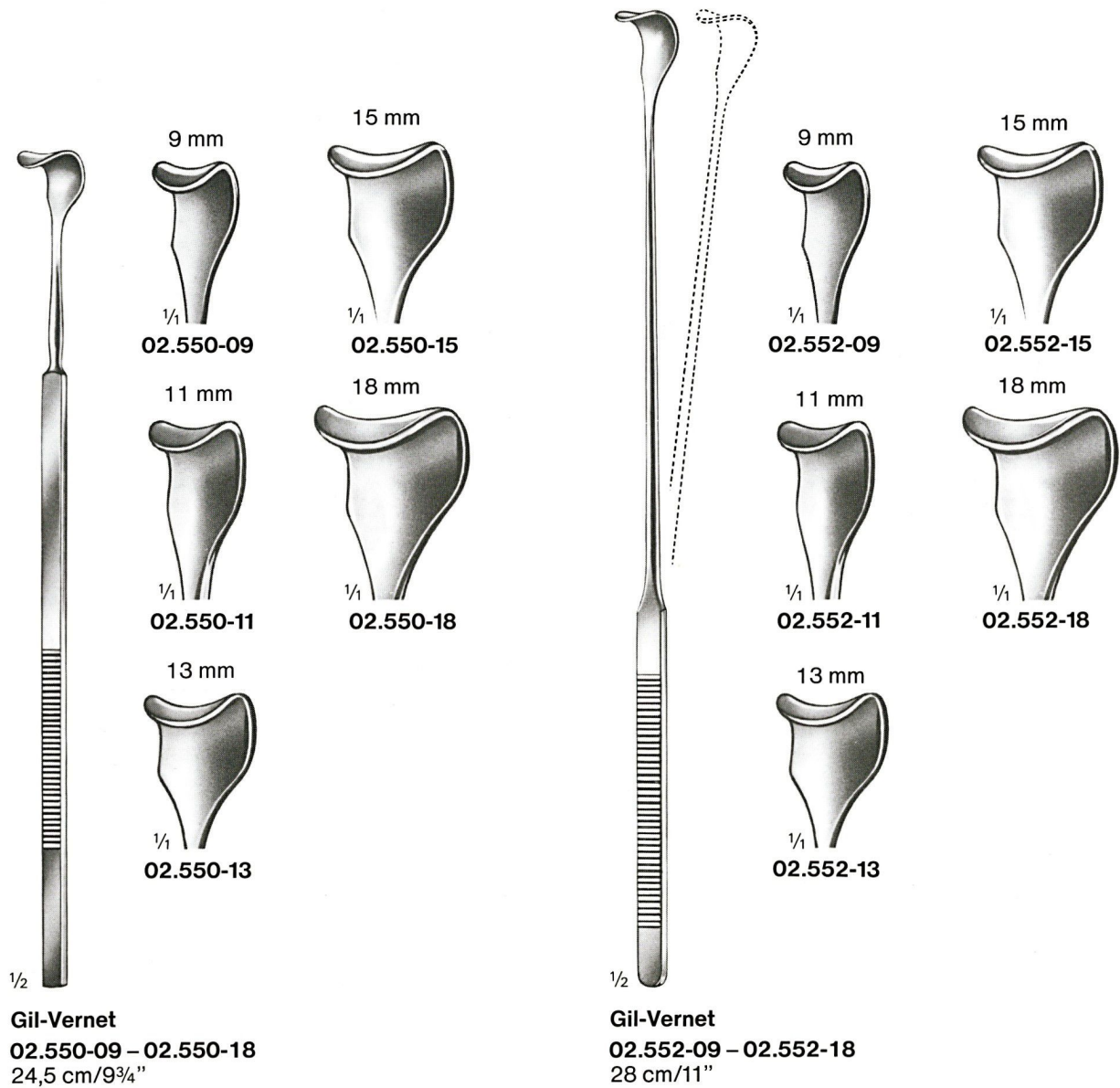



02.572-30 = 245 × 30 mm
02.572-40 = 245 × 40 mm
02.572-50 = 245 × 50 mm
02.572-60 = 245 × 60 mm
02.572-70 = 245 × 70 mm
41 cm/16"

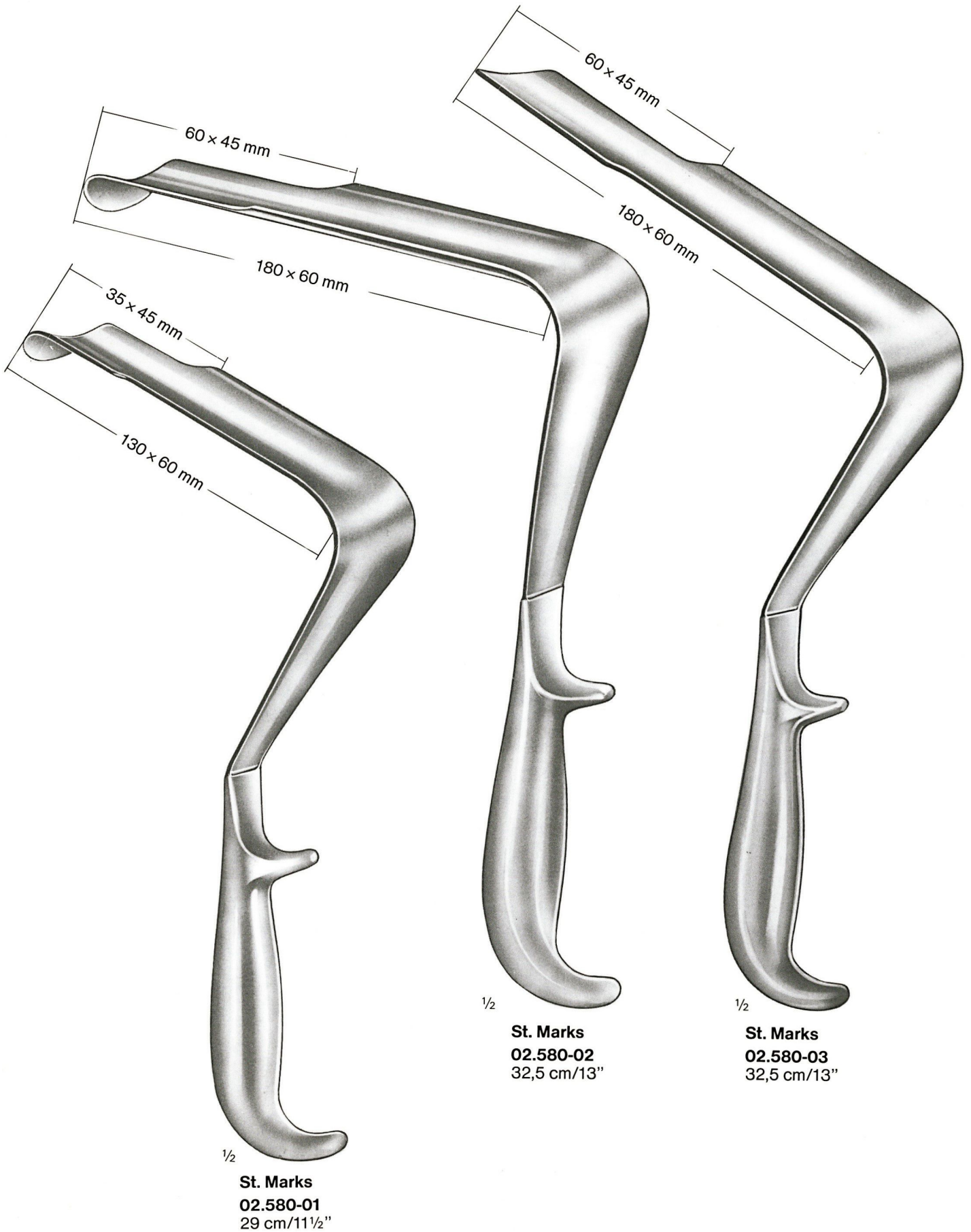

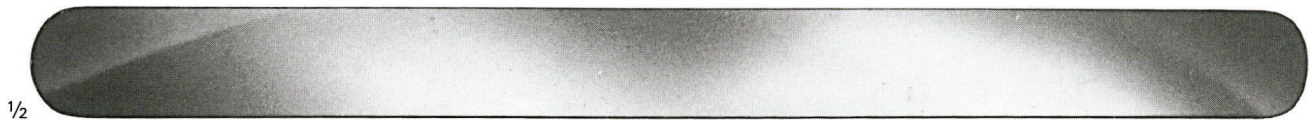
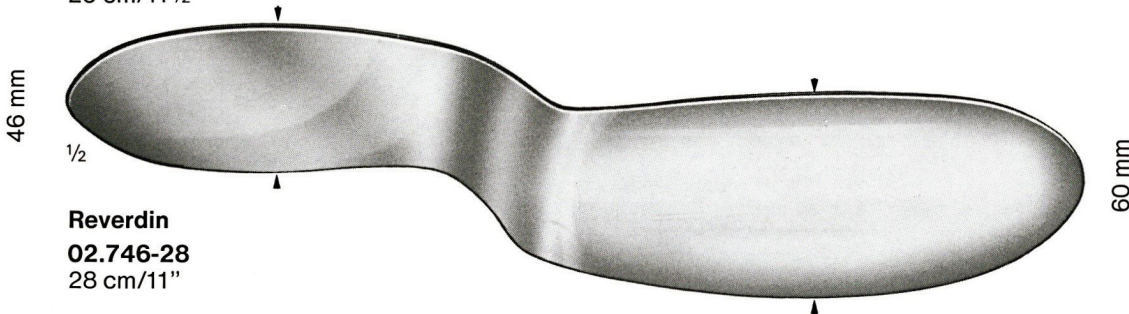
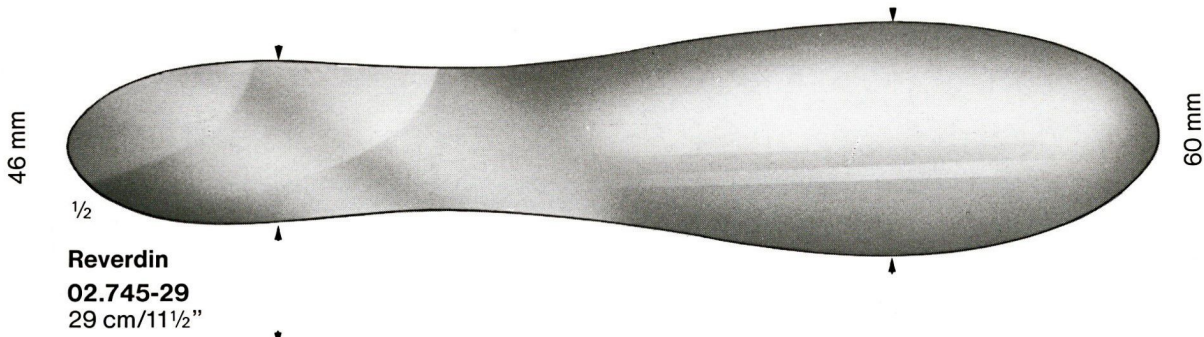

02.750-01 = 330 × 20 mm
02.750-02 = 330 × 25 mm
02.750-03 = 330 × 30 mm
02.750-04 = 330 × 40 mm
02.750-05 = 330 × 50 mm
 33 cm/13"

biegsam
 malleable
 malléable
 maleable

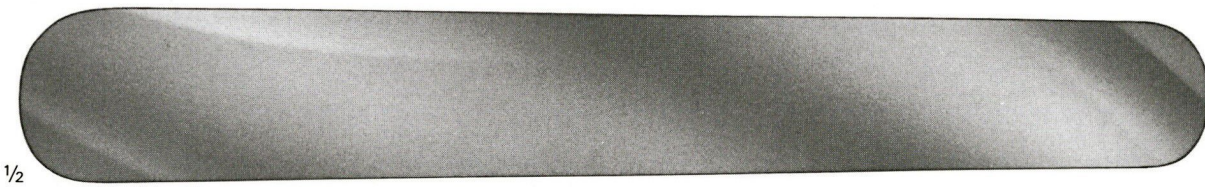

Haberer

02.752-01 28 cm/11" 25/30 mm
02.752-02 30 cm/12" 37/45 mm
02.752-03 30 cm/12" 40/50 mm

biegsam
 malleable
 malléable
 maleable

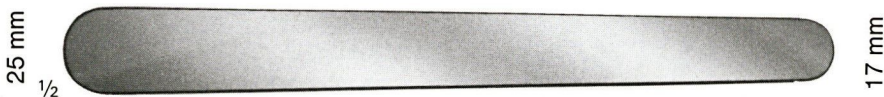

Tuffier

02.754-20
 17 × 25 mm
 20 cm/8"

biegsam
 malleable
 malléable
 maleable

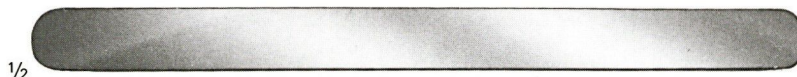

02.760-06 = 200 × 6 mm
02.760-08 = 200 × 8 mm
02.760-10 = 200 × 10 mm
02.760-12 = 200 × 12 mm

02.760-17 = 200 × 17 mm
02.760-20 = 200 × 20 mm
02.760-25 = 200 × 25 mm
02.761-25 = 250 × 25 mm

biegsam
 malleable
 malléable
 maleable

Kiefer- und Gesichtschirurgie

Jaw- and Face Surgery

Ecarteurs pour la chirurgie
maxillo-faciale

Separadores para cirugía
plástica



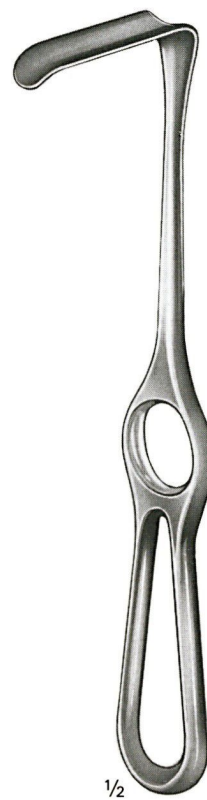
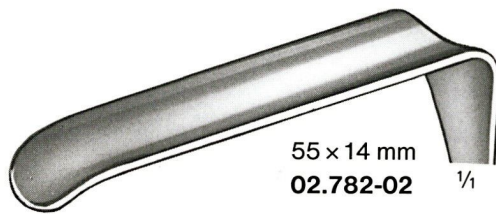

Dockhorn
02.782-01 – 02.782-02
20 cm/8"

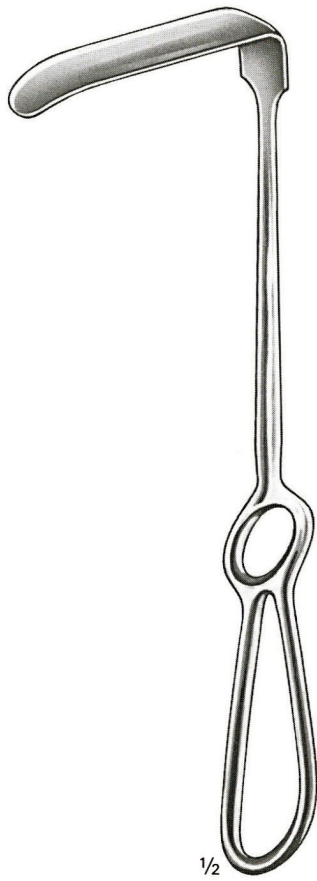

02.800-01 – 02.800-11
22 cm / 8 3/4"

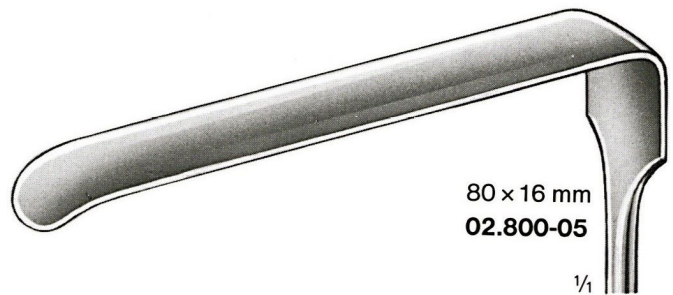
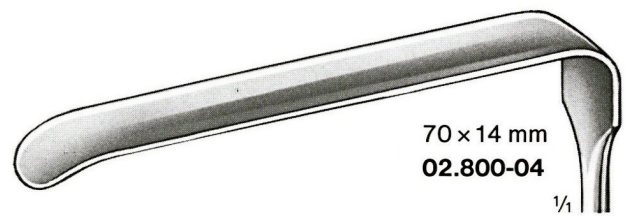
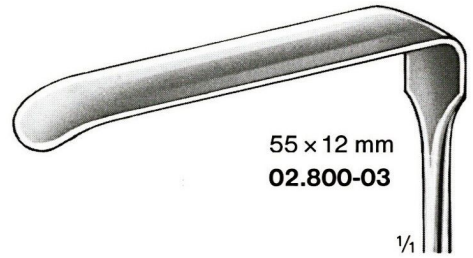
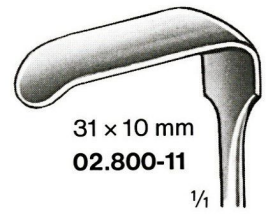
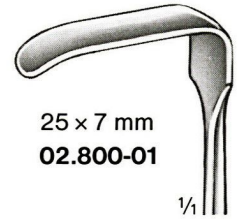

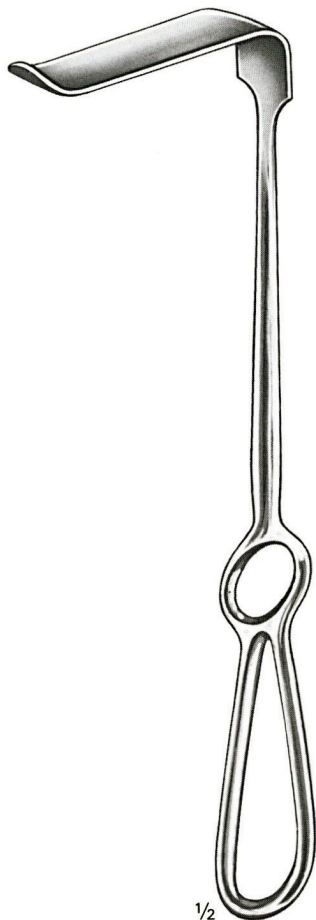
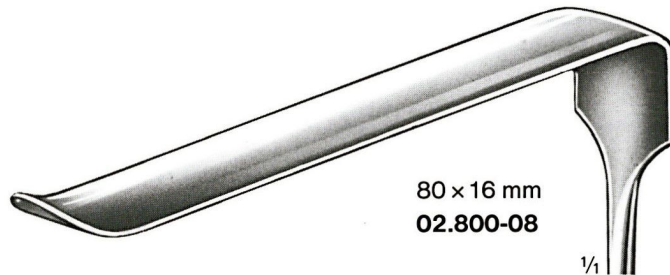
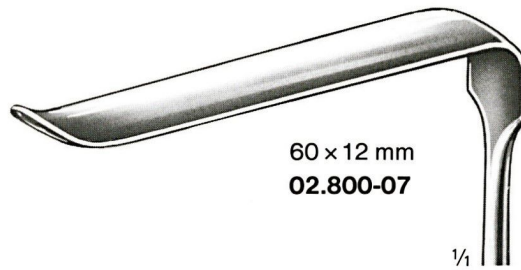
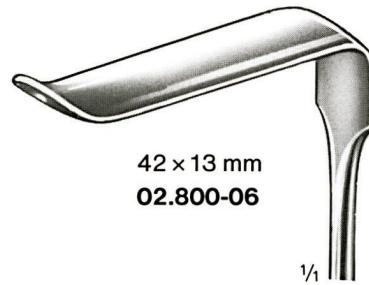

02.800-06 – 02.800-08
22 cm/8³/₄"

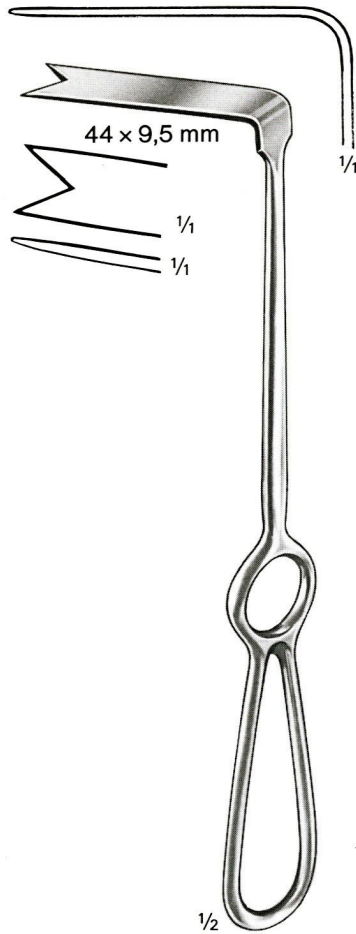

$\frac{1}{2}$
Spina-Nasalis
02.801-00
22 cm/8 $\frac{3}{4}$ "

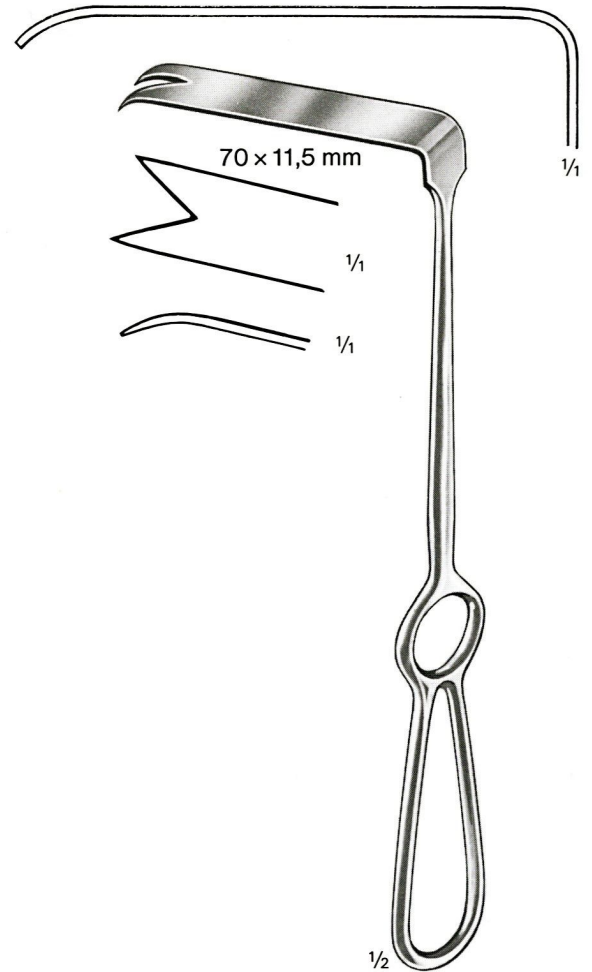

$\frac{1}{2}$
Ramus
02.802-00
22 cm/8 $\frac{3}{4}$ "

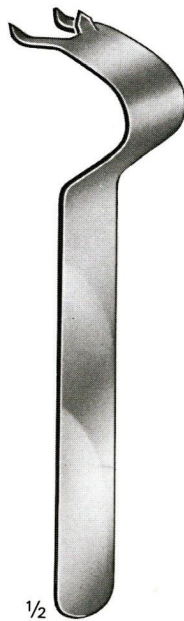

$\frac{1}{2}$
02.803-15
15,5 cm/6"

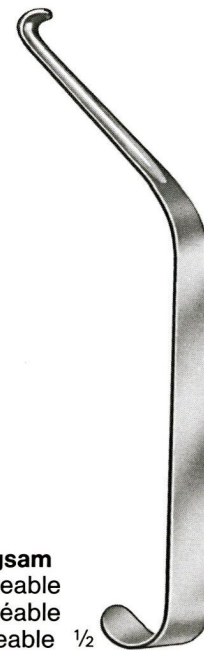

biegsam
malleable
malléable
maleable $\frac{1}{2}$
02.804-16
16 cm/6 $\frac{1}{4}$ "



02.808-00
21 cm/8"

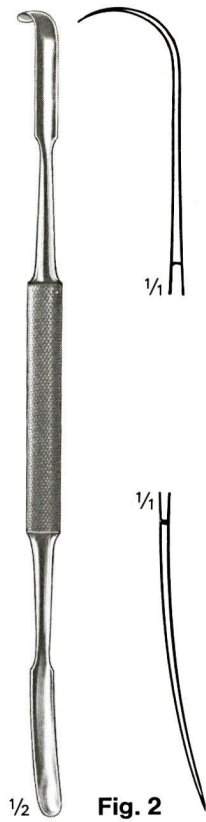

02.809-00
20,5 cm/8"

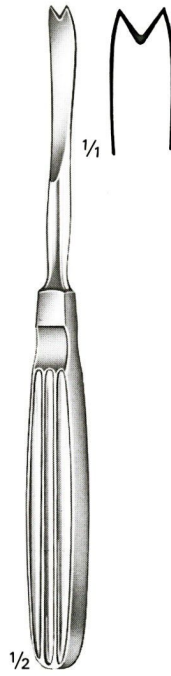

02.810-17
17,5 cm/7"

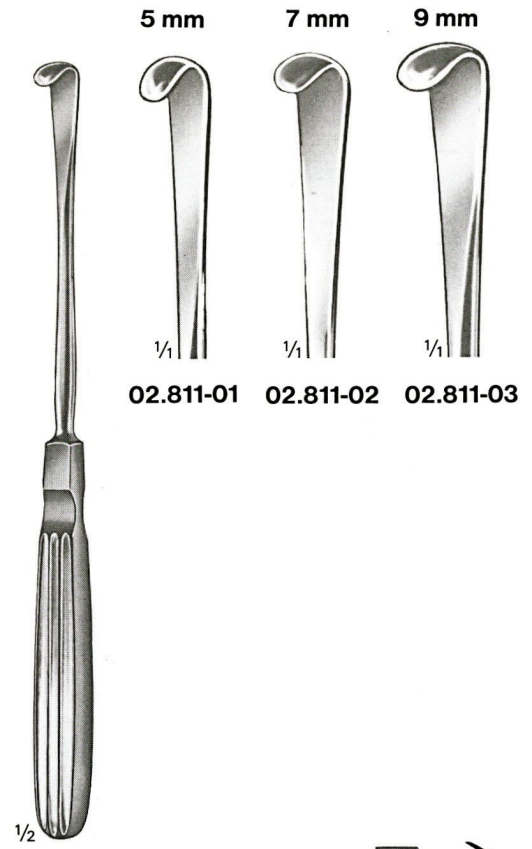

02.811-01 – 02.811-03
20 cm/8"

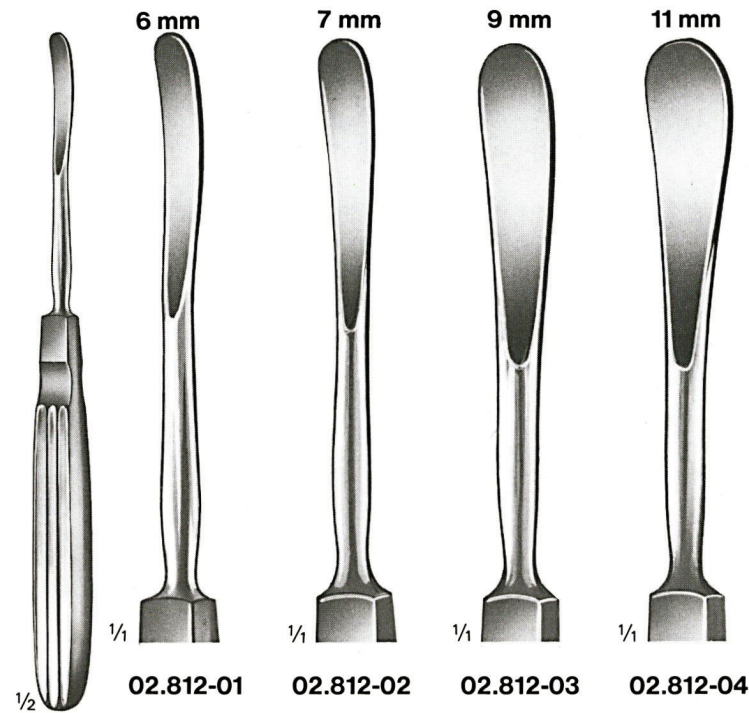

02.812-01 – 02.812-04
17,5 cm/7"

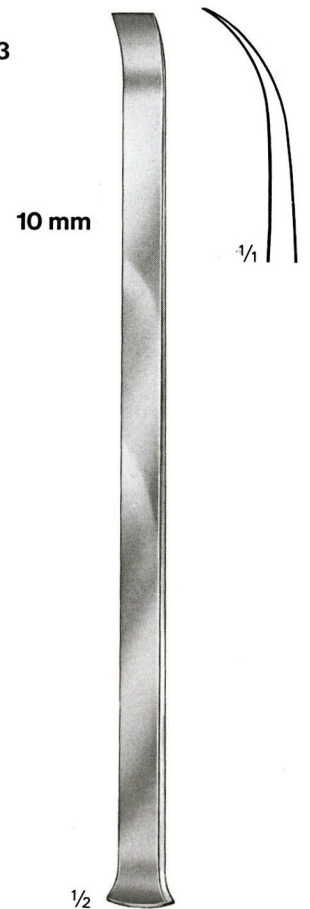

02.814-00
23,5 cm/8 3/4"

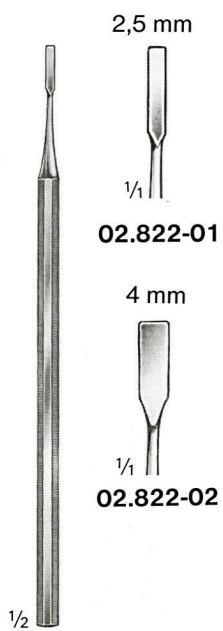
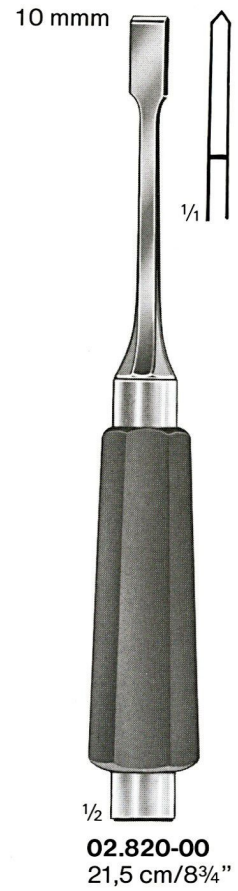
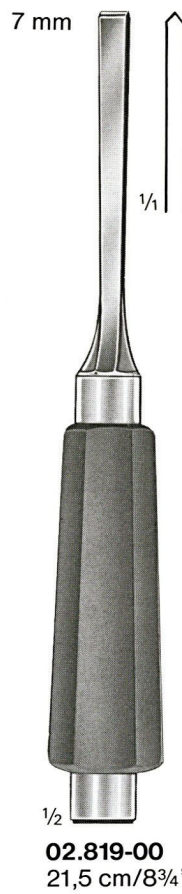
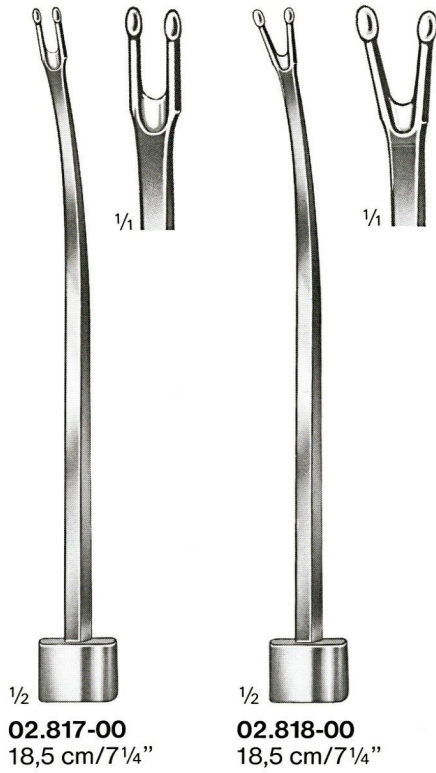

02.822-01 – 02.822-02
15 cm/6"

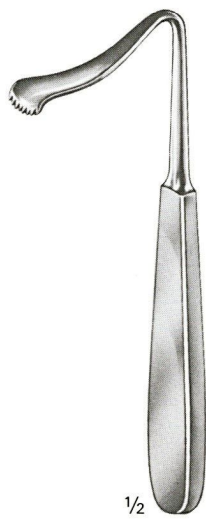

Bowdler-Henry's
02.823-00
16,5 cm/6 1/2"

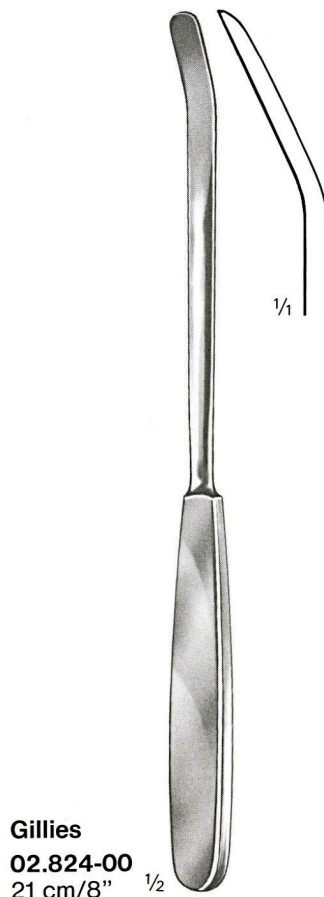

Gillies
02.824-00
21 cm/8"



Gillies
02.825-00
21 cm/8"



02.827-14
 14 cm/5½"



02.828-23
 23 cm/8¾"



02.829-18
 18 cm/7"

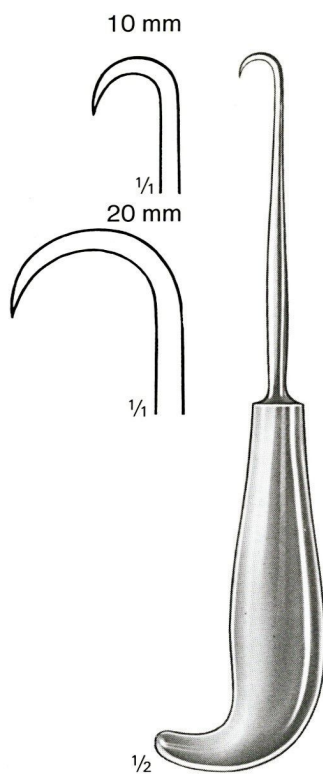

02.840-10 10 mm
 19 cm/7½"

02.840-20 20 mm
 19 cm/7½"



Dingman
02.844-21
 21 cm/8"

Sonden, Watteträger,
Winkelmesser

Probes, Cotton-Applicators,
Measuring Instruments

Sondes, Porte-coton,
Rapporteurs

Sondas, Porta-algodones,
Instrumentos para medidas





$\frac{1}{2}$
 1 mm Ø

cm	in.	Nr.
11,5	4½	03.200-11
13	5	03.200-13
14,5	5¾	03.200-14
16	6¼	03.200-16
18	7	03.200-18
20	8	03.200-20
25	10	03.200-25



$\frac{1}{2}$
 1,5 mm Ø

cm	in.	Nr.
11,5	4¼	03.201-11
13	5	03.201-13
14,5	5¾	03.201-14
16	6¼	03.201-16
18	7	03.201-18
20	8	03.201-20



$\frac{1}{2}$
 2 mm Ø

cm	in.	Nr.
11,5	4½	03.202-11
13	5	03.202-13
14,5	5¾	03.202-14
16	6¼	03.202-16
18	7	03.202-18
20	8	03.202-20
25	10	03.202-25



cm	in.	Nr.		
10,5	4¼	03.210-10		
11,5	4½		03.211-11	
13	5	03-210-13	03.211-13	
14	5¼			03.213-14
14,5	5½	03.210-14	03.211-14	
16	6¼	03.210-16		
18	7		03.211-18	
20	8	03.210-20	03.211-20	

Unterbindungsnadeln,
Führungshohlsonden,
Fadenfänger

Ligature Needles, Ligature
Conductors, Suture Hook

Aiguilles à ligatures,
Sondes conductrices,
Porte-ligatures

Agujas para ligaduras,
Sondas conductoras,
Porta ligaduras

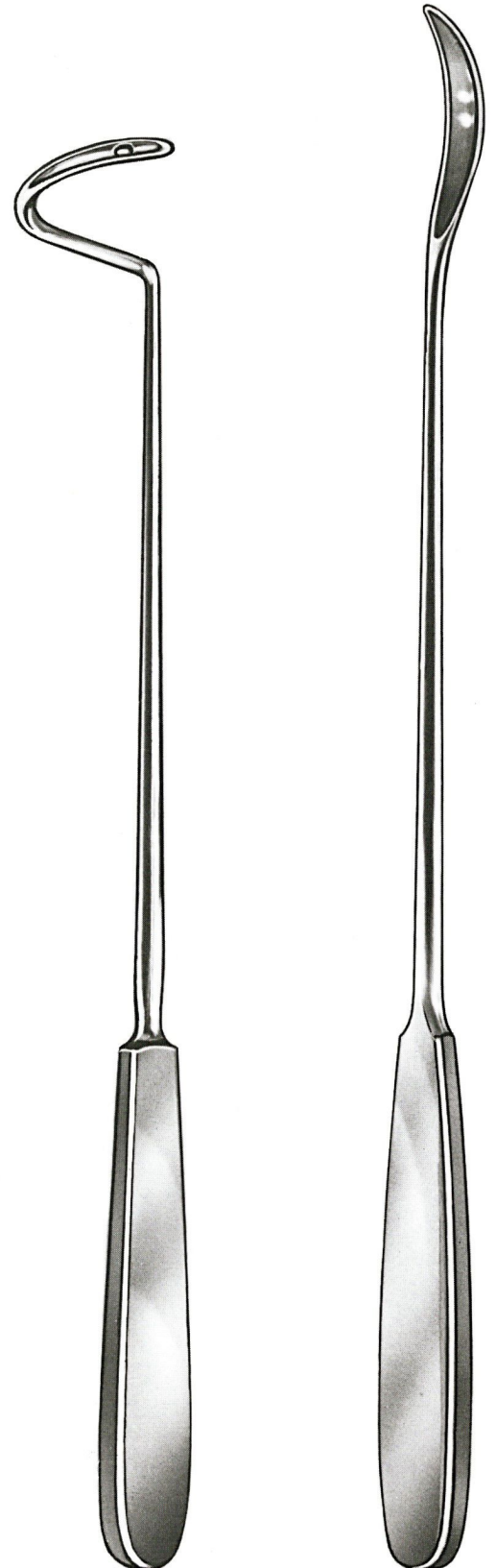

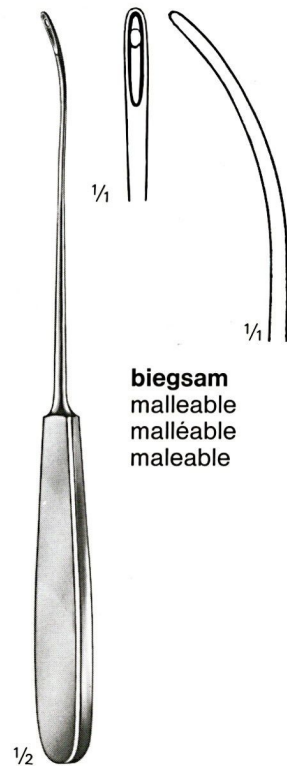

biegsam
malleable
malléable
maleable

05.545-20
23 cm/8³/₄"

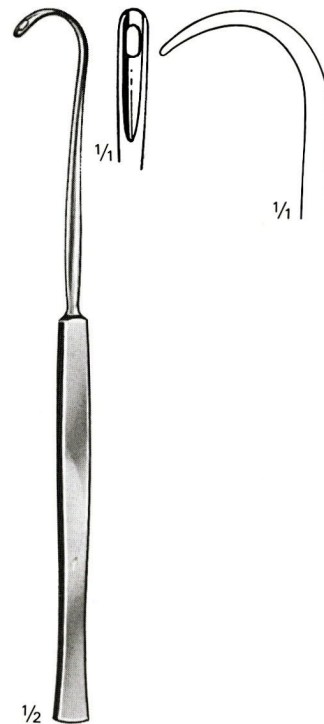

Cooper
05.546-19
19 cm/7¹/₂"

für die rechte Hand	für die linke Hand	für die rechte Hand	für die linke Hand	für die rechte Hand	für die linke Hand
for the right hand	for the left hand	for the right hand	for the left hand	for the right hand	for the left hand
pour la main droite	pour la main gauche	pour la main droite	pour la main gauche	pour la main droite	pour la main gauche
para la mano derecha	para la mano izquierda	para la mano derecha	para la mano izquierda	para la mano derecha	para la mano izquierda

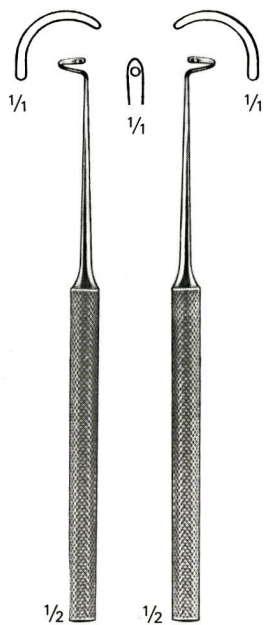

Kronecker **Kronecker**
05.747-13 **05.748-13**
 13 cm/6" 13 cm/6"

stumpf **stumpf**
 blunt blunt
 mousse mousse
 romo romo

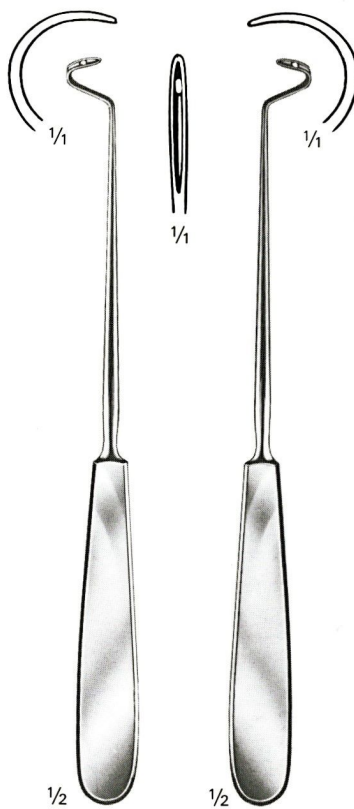

Deschamps **Deschamps**
05.749-20 **05.750-20**
 20 cm/8" 20 cm/8"

stumpf **stumpf**
 blunt blunt
 mousse mousse
 romo romo

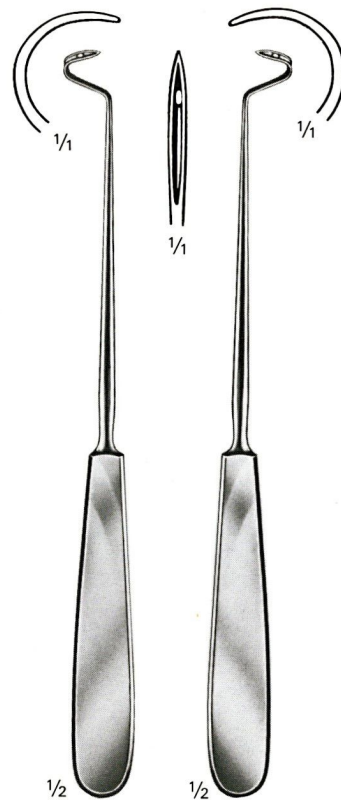

Deschamps **Deschamps**
05.751-20 **05.752-20**
 20 cm/8" 20 cm/8"

scharf **scharf**
 sharp sharp
 pointue pointue
 agudo agudo

für die
rechte Hand

for the
right hand

pour la
main droite

para la
mano derecha

für die
linke Hand

for the
left hand

pour la
main gauche

para la
mano izquierda

für die
rechte Hand

for the
right hand

pour la
main droite

para la
mano derecha

für die
linke Hand

for the
left hand

pour la
main gauche

para la
mano izquierda

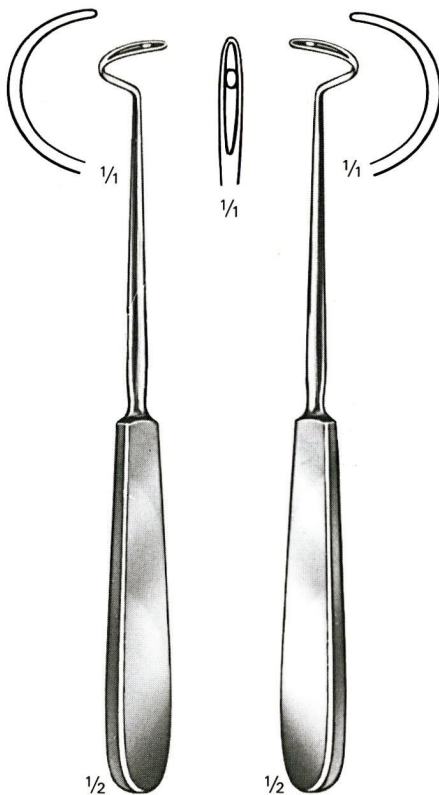

Deschamps
05.753-20
20 cm/8"

stumpf
blunt
mousse
romo

Deschamps
05.754-20
20 cm/8"

stumpf
blunt
mousse
romo

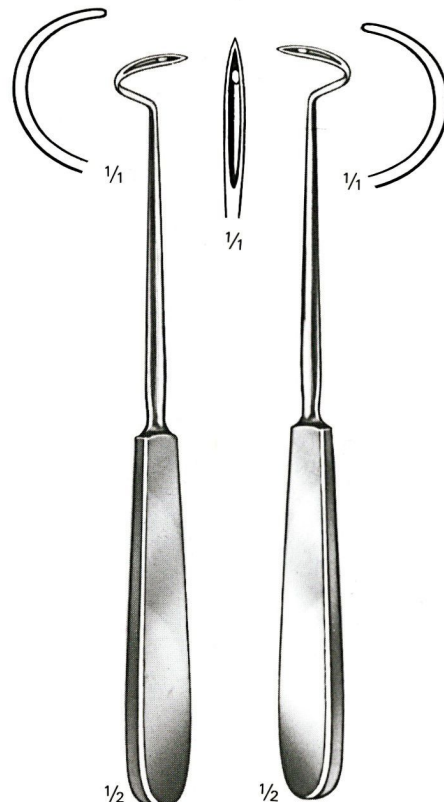

Deschamps
05.755-20
20 cm/8"

scharf
sharp
pointue
agudo

Deschamps
05.756-20
20 cm/8"

scharf
sharp
pointue
agudo

für die rechte Hand

for the right hand

pour la main droite

para la mano derecha

für die linke Hand

for the left hand

pour la main gauche

para la mano izquierda

für die rechte Hand

for the right hand

pour la main droite

para la mano derecha

für die linke Hand

for the left hand

pour la main gauche

para la mano izquierda

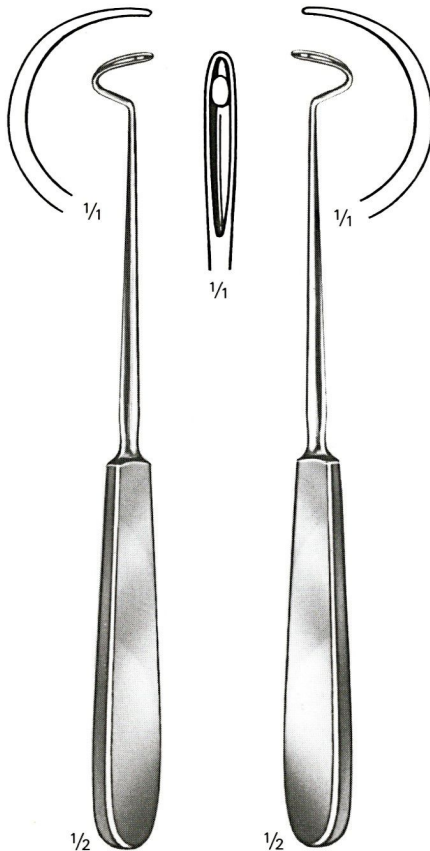

Deschamps
05.757-21
 21 cm/8¼"

stumpf
 blunt
 mousse
 romo

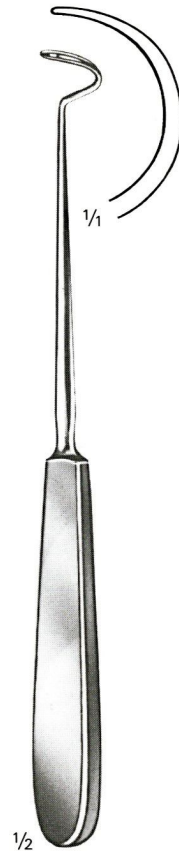

Deschamps
05.758-21
 21 cm/8¼"

stumpf
 blunt
 mousse
 romo

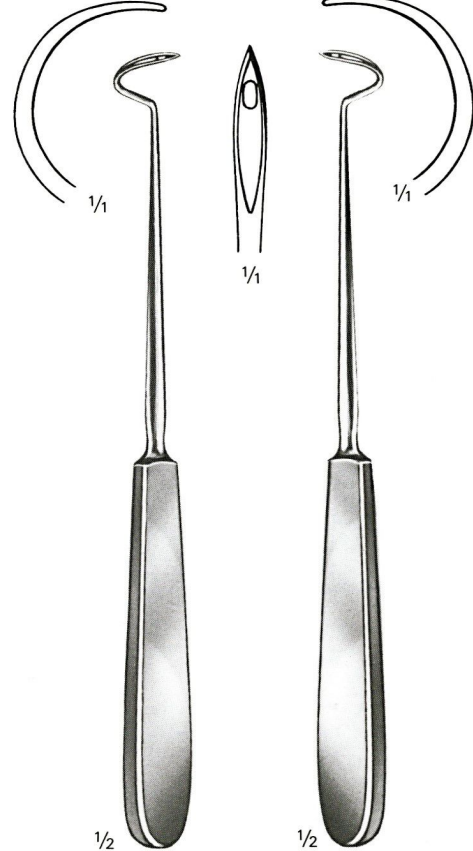

Deschamps
05.759-21
 21 cm/8¼"

scharf
 sharp
 pointue
 agudo

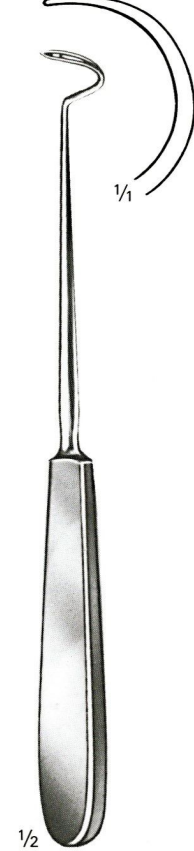

Deschamps
05.760-21
 21 cm/8¼"

scharf
 sharp
 pointue
 agudo

für die rechte Hand	für die linke Hand	für die rechte Hand	für die linke Hand	für die rechte Hand	für die linke Hand
for the right hand	for the left hand	for the right hand	for the left hand	for the right hand	for the left hand
pour la main droite	pour la main gauche	pour la main droite	pour la main gauche	pour la main droite	pour la main gauche
para la mano derecha	para la mano izquierda	para la mano derecha	para la mano izquierda	para la mano derecha	para la mano izquierda

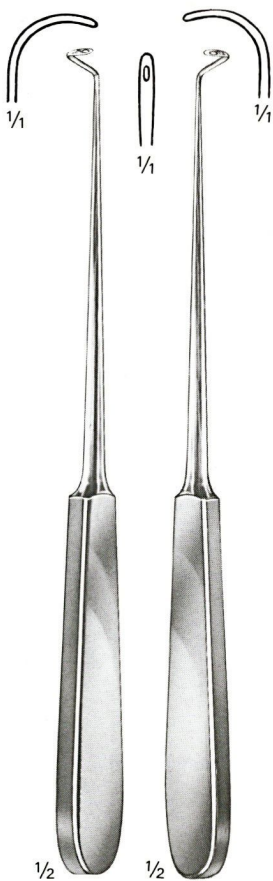

Deschamps 05.761-22 22,5 cm/9"
Deschamps 05.762-22 22,5 cm/9"

stumpf
blunt
mousse
romo

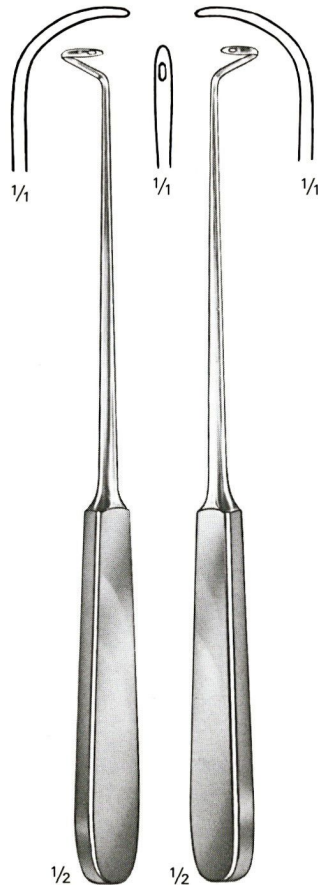

Deschamps 05.763-22 22,5 cm/9"
Deschamps 05.764-22 22,5 cm/9"

stumpf
blunt
mousse
romo

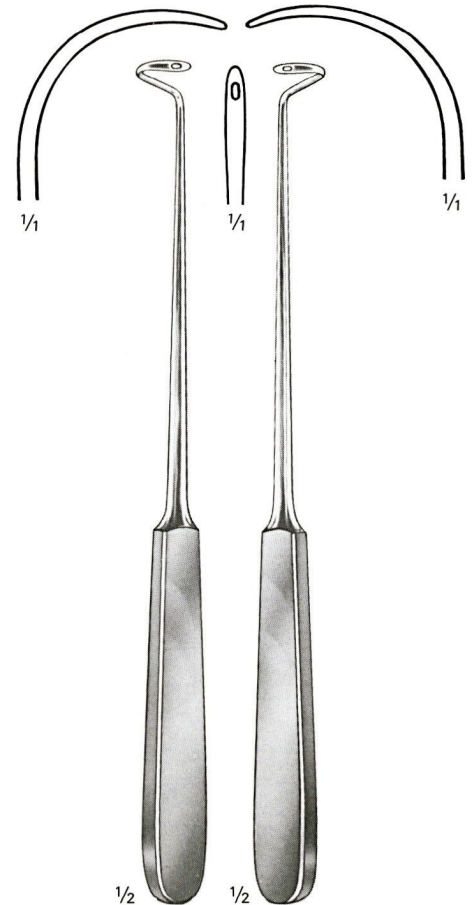

Deschamps 05.765-22 22,5 cm/9"
Deschamps 05.766-22 22,5 cm/9"

stumpf
blunt
mousse
romo

für die rechte Hand

for the right hand

pour la main droite

para la mano derecha

für die linke Hand

for the left hand

pour la main gauche

para la mano izquierda

für die rechte Hand

for the right hand

pour la main droite

para la mano derecha

für die linke Hand

for the left hand

pour la main gauche

para la mano izquierda

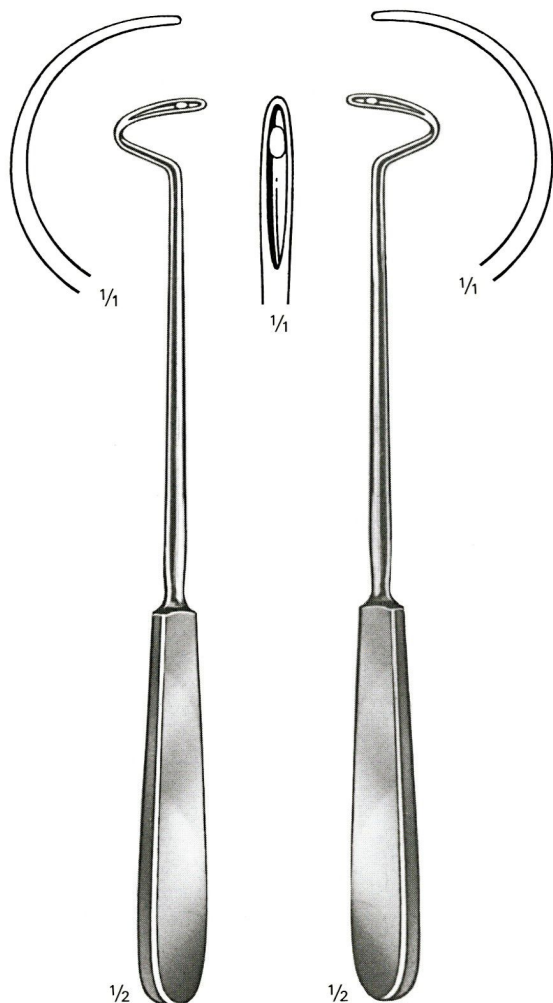

Deschamps
05.767-24
 24 cm/9½"

stumpf
 blunt
 mousse
 romo

Deschamps
05.768-24
 24 cm/9½"

stumpf
 blunt
 mousse
 romo

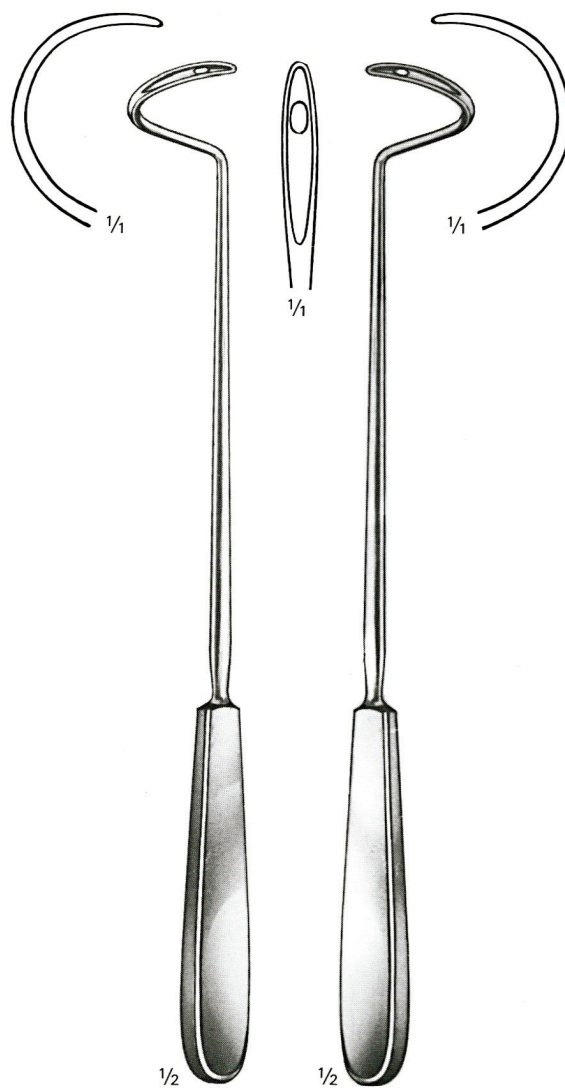

Deschamps
05.769-27
 27 cm/10½"

stumpf
 blunt
 mousse
 romo

Deschamps
05.770-27
 27 cm/10½"

stumpf
 blunt
 mousse
 romo

für die
rechte Hand

for the
right hand

pour la
main droite

para la
mano derecha

für die
linke Hand

for the
left hand

pour la
main gauche

para la
mano izquierda

für die
rechte Hand

for the
right hand

pour la
main droite

para la
mano derecha

für die
linke Hand

for the
left hand

pour la
main gauche

para la
mano izquierda

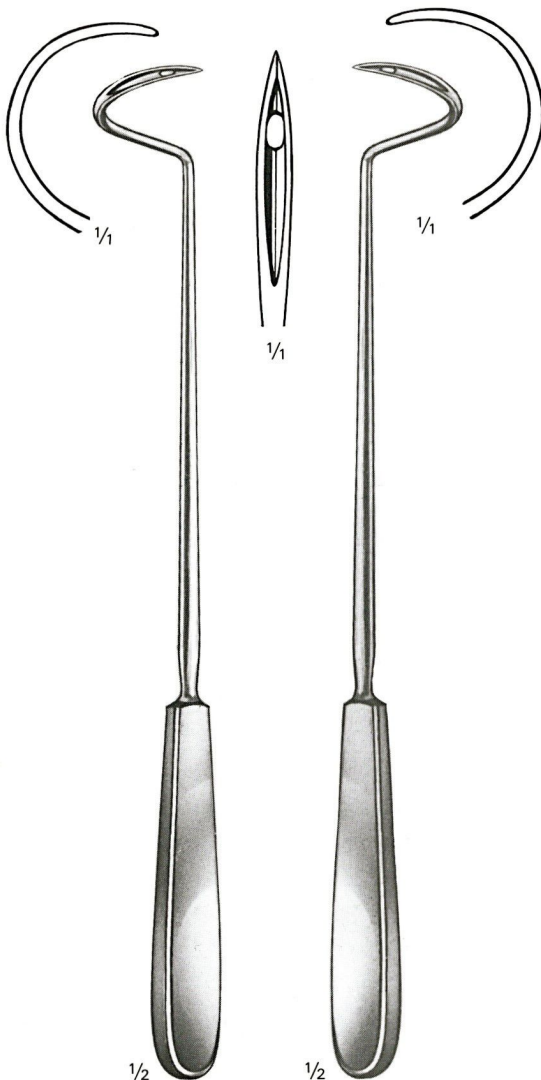

$\frac{1}{2}$
Deschamps
05.771-27
27 cm/10 $\frac{1}{2}$ "

scharf
sharp
pointue
agudo

$\frac{1}{2}$
Deschamps
05.772-27
27 cm/10 $\frac{1}{2}$ "

scharf
sharp
pointue
agudo

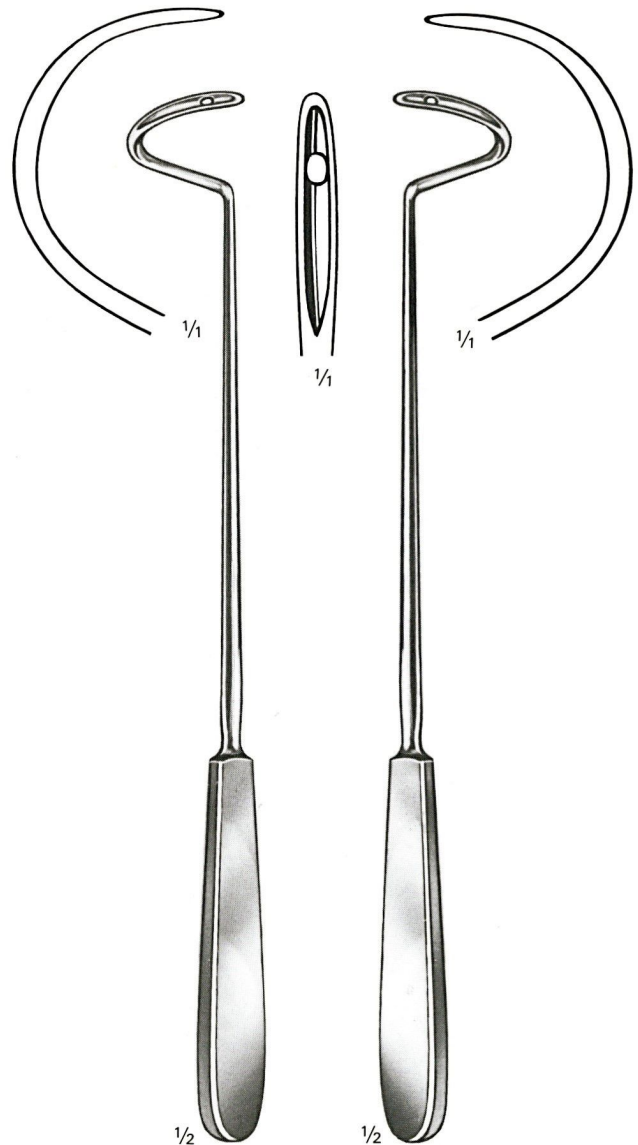

$\frac{1}{2}$
Deschamps
05.773-28
28 cm/11"

stumpf
blunt
mousse
romo

$\frac{1}{2}$
Deschamps
05.774-28
28 cm/11"

stumpf
blunt
mousse
romo

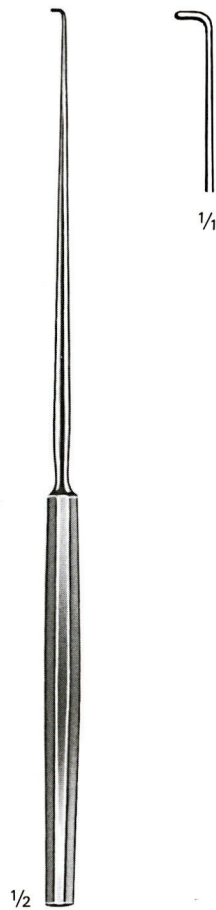

Modell Wien
05.800-23
23,5 cm/9 $\frac{1}{4}$ "

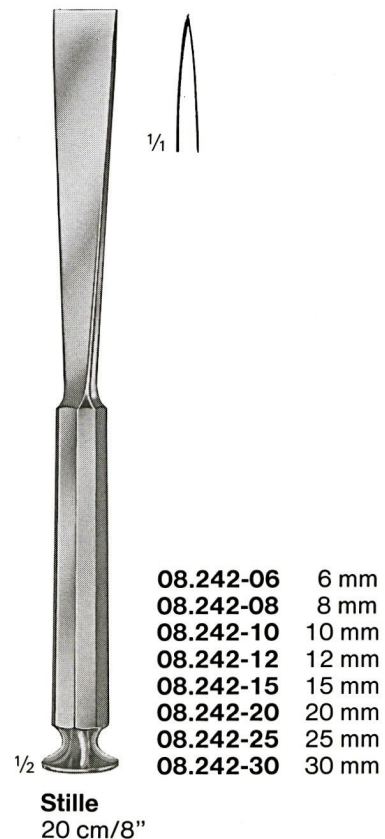
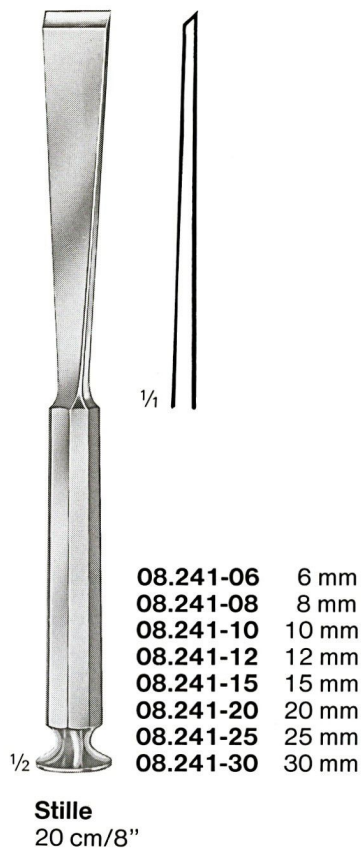
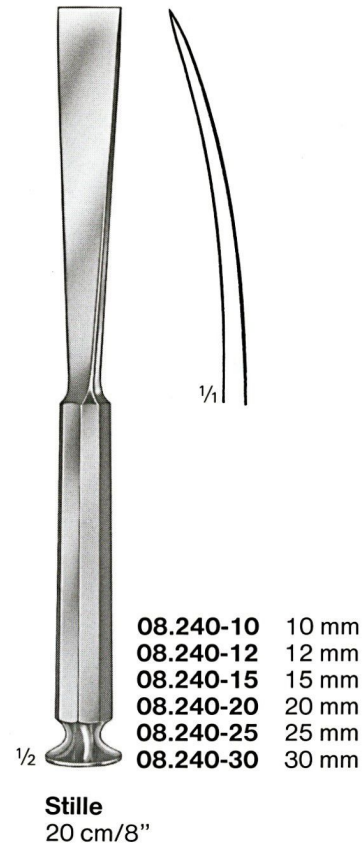
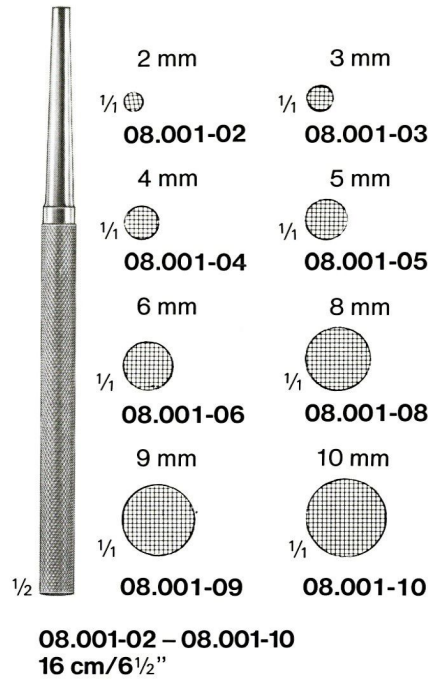

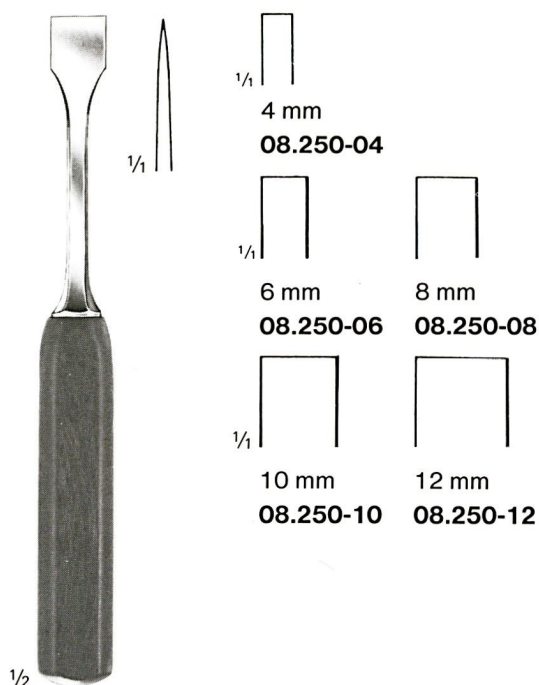

Mini-Lexer
08.250-04 – 08.250-12
18 cm/7"

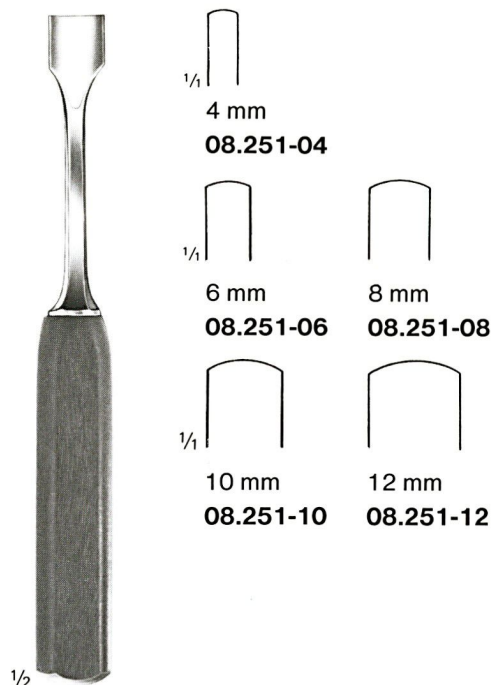

Mini-Lexer
08.251-04 – 08.251-12
18 cm/7"

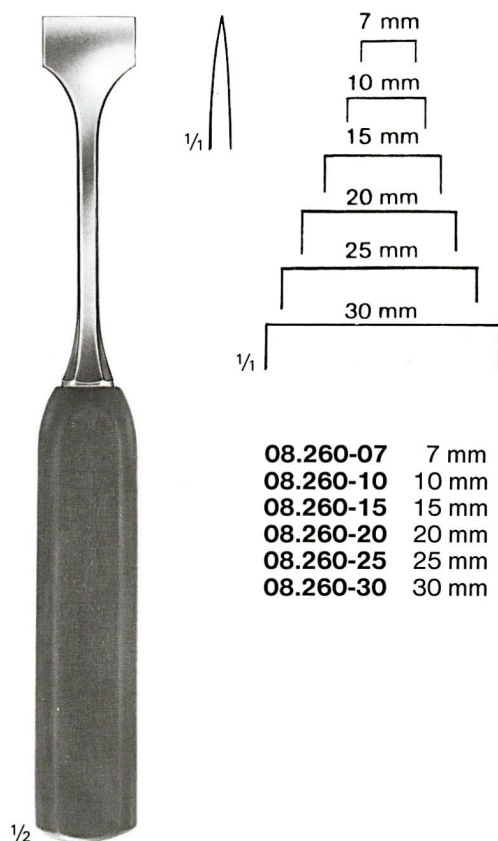

Lexer
08.260-07 – 08.260-30
22 cm/8 3/4"

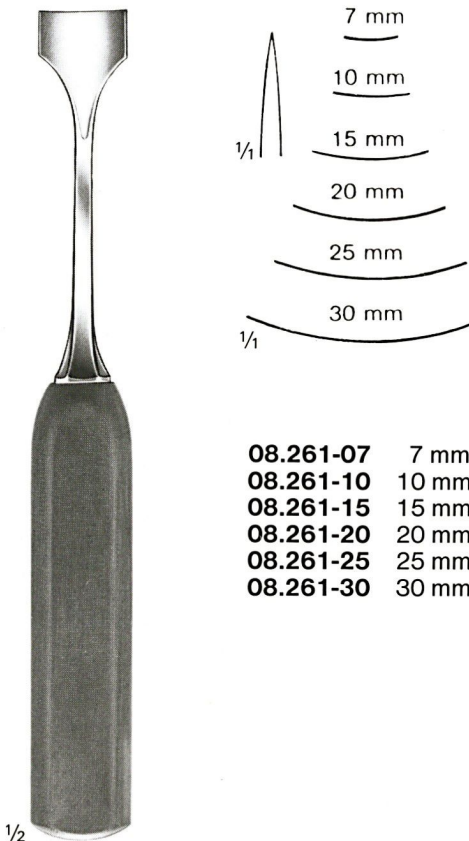

Lexer
08.261-07 – 08.261-30
22 cm/8 3/4"

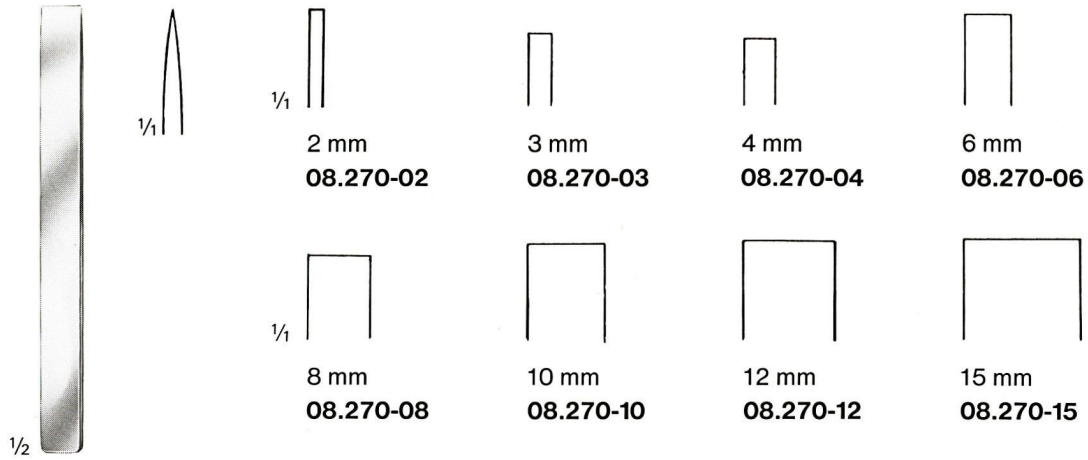

Mini-Lambotte

08.270-02 – 08.270-15
12,5 cm/5"

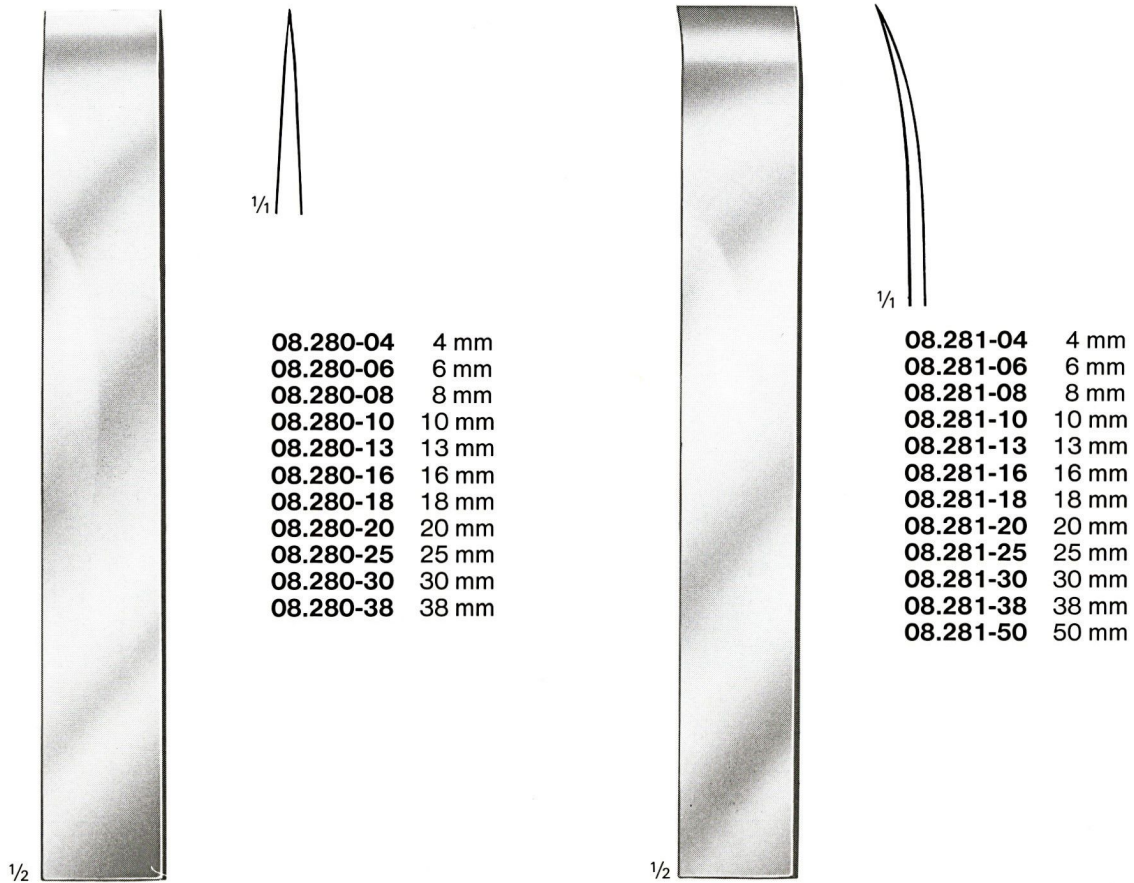

Lambotte

08.280-04 – 08.280-50
25 cm/10"

Lambotte

08.281-04 – 08.281-50
23 cm/8³/₄"



25 cm/10"

08.344-05 5 mm
08.344-10 10 mm
08.344-15 15 mm

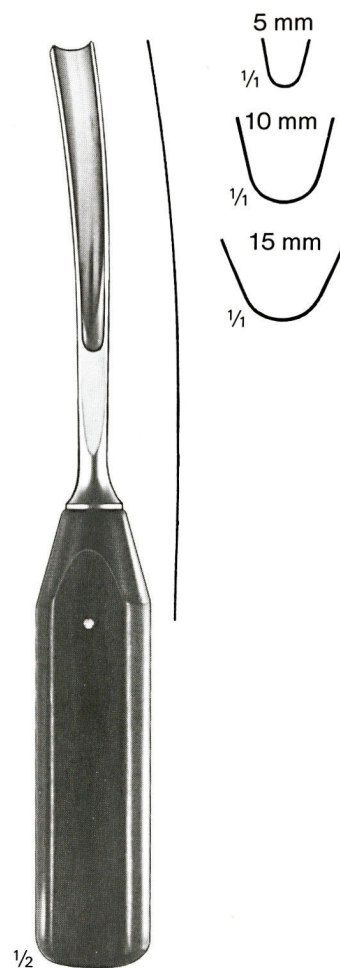

25 cm/10"

08.345-05 5 mm
08.345-10 10 mm
08.345-15 15 mm

Scharfe Löffel, Raspatorien,
Elevatorien, Knochenheber,
Dissektoren, Nervhaken

Bone Currettes, Raspatories,
Elevators
Bone Levers, Dissectors,
Nerve Hooks

Curettes tranchantes, Rugines,
Elévateurs,
Leviers à os, Dissecteurs,
Crochet à nerfs

Cucharillas cortantes,
Periostótomos,
Elevadores,
Elevadores para huesos,
Disectores,
Ganchos para nervios

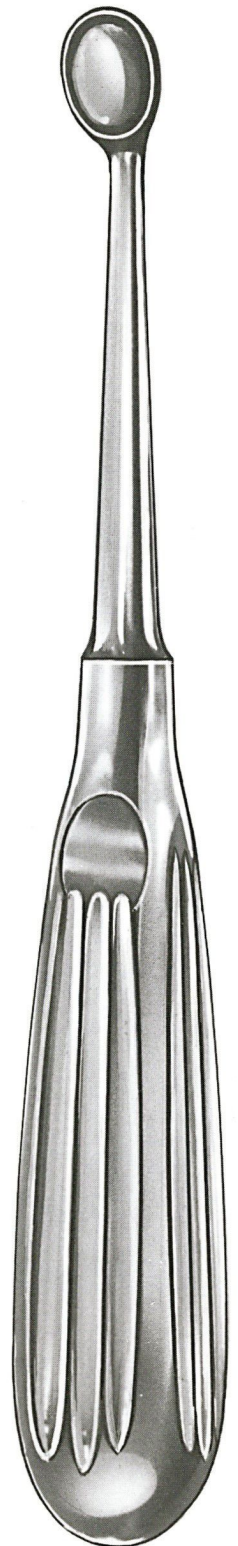

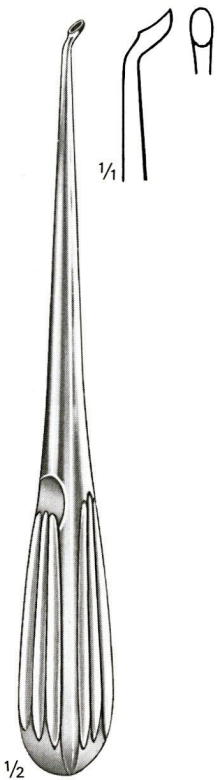
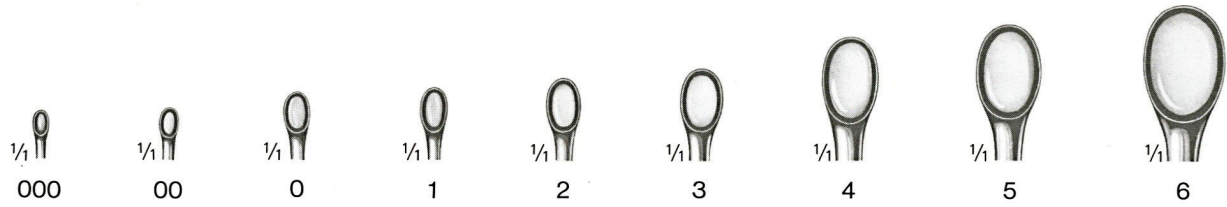

Epstein
 20 cm/8"

- 08.400-30 Fig. 000
- 08.400-20 Fig. 00
- 08.400-10 Fig. 0



Spinal
 20 cm/8"

- 08.402-30 Fig. 000
- 08.402-20 Fig. 00
- 08.402-10 Fig. 0
- 08.403-01 Fig. 1
- 08.403-02 Fig. 2
- 08.403-03 Fig. 3
- 08.403-04 Fig. 4
- 08.403-05 Fig. 5
- 08.403-06 Fig. 6



Spinal
 20 cm/8"

- 08.404-30 Fig. 000
- 08.404-20 Fig. 00
- 08.404-10 Fig. 0
- 08.405-01 Fig. 1
- 08.405-02 Fig. 2
- 08.405-03 Fig. 3
- 08.405-04 Fig. 4
- 08.405-05 Fig. 5
- 08.405-06 Fig. 6

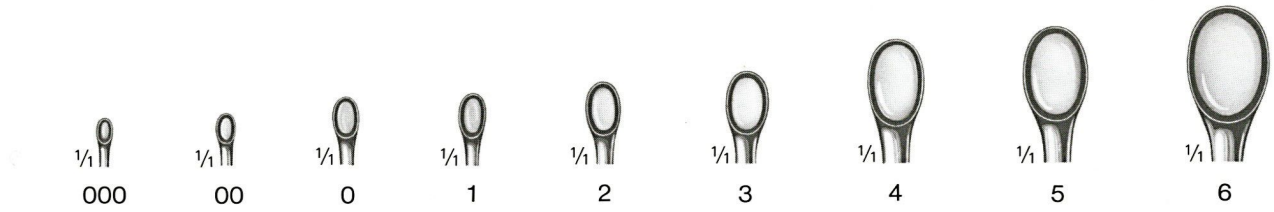

Bruns
23 cm/9"

- 08.406-30 Fig. 000
- 08.406-20 Fig. 00
- 08.406-10 Fig. 0
- 08.407-01 Fig. 1
- 08.407-02 Fig. 2
- 08.407-03 Fig. 3
- 08.407-04 Fig. 4
- 08.407-05 Fig. 5
- 08.407-06 Fig. 6



Bruns
23 cm/9"

- 08.410-30 Fig. 000
- 08.410-20 Fig. 00
- 08.410-10 Fig. 0
- 08.411-01 Fig. 1
- 08.411-02 Fig. 2
- 08.411-03 Fig. 3
- 08.411-04 Fig. 4
- 08.411-05 Fig. 5
- 08.411-06 Fig. 6

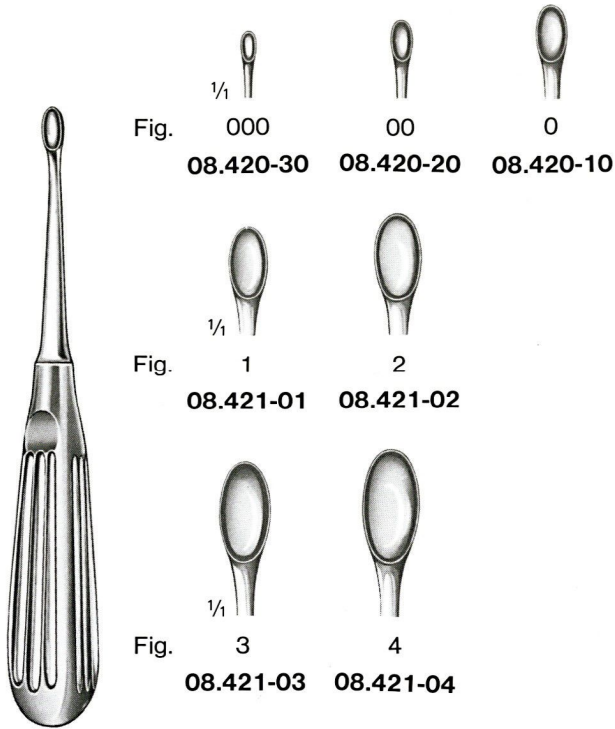

Schede
 08.420-30 – 08.421-04
 17 cm/6¾"

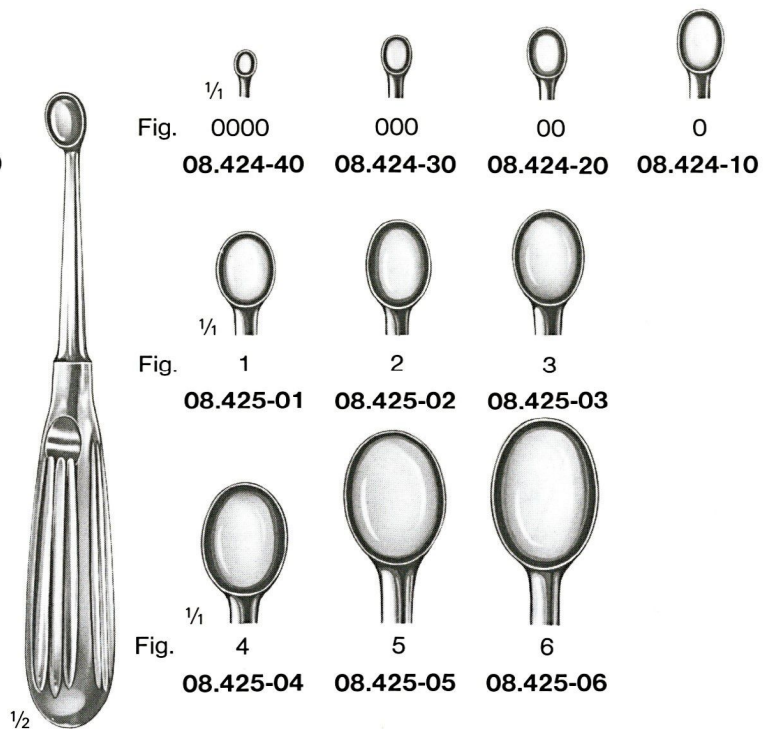

Volkmann
 08.424-40 – 08.425-06
 17 cm/6¾"

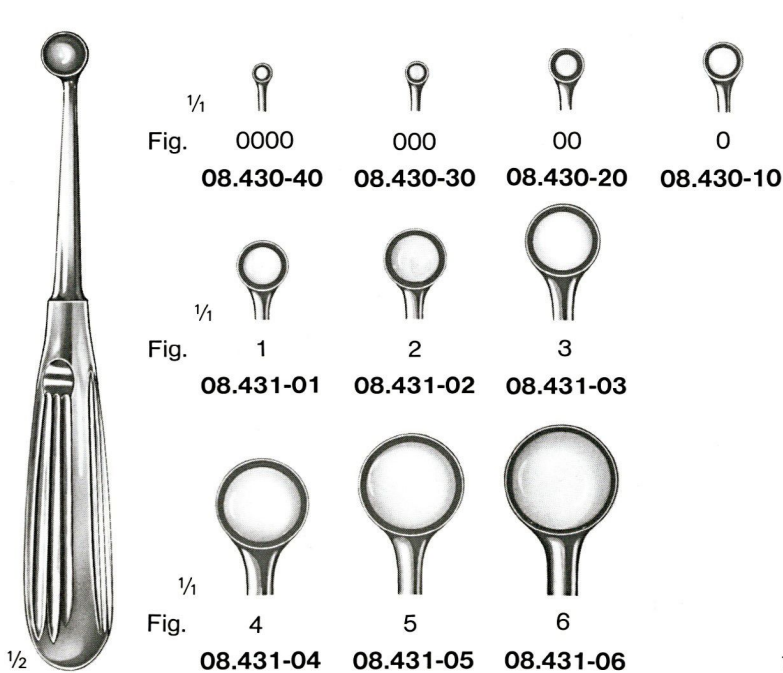

Bruns
 08.430-40 – 08.431-06
 17 cm/6¾"

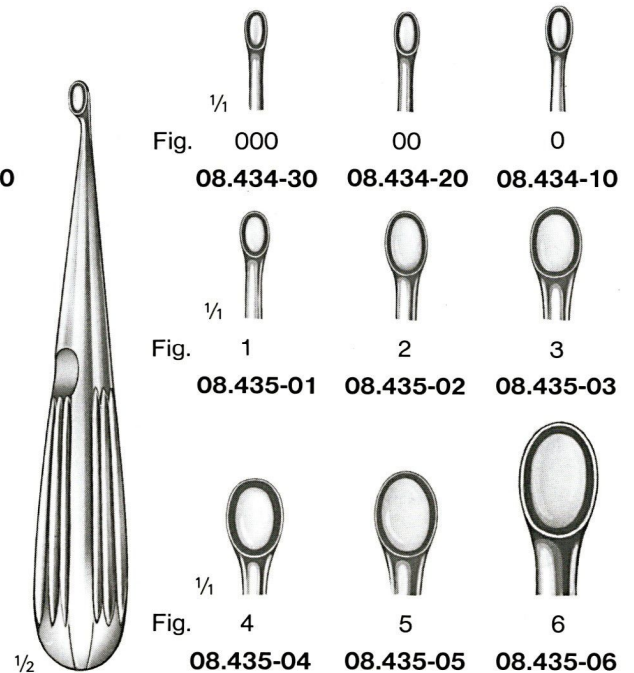

Spratt
 08.434-30 – 08.435-06
 16 cm/6¼"



Simon
08.470-40 – 08.470-10
24 cm/9½"

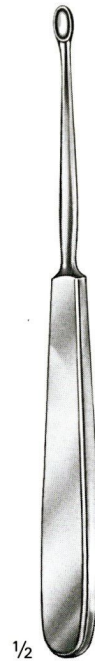
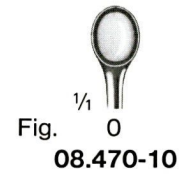
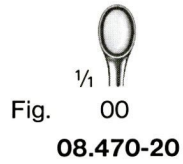
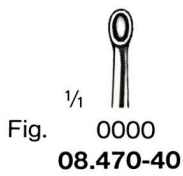

Williger
08.450-20 – 08.453-02
17,5 cm/7"

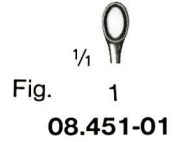

08.465-10 – 08.466-03
27 cm/10¾"

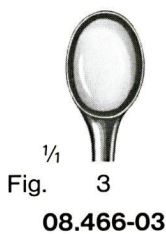
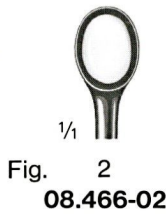

Simon
08.471-01 – 08.471-06
24 cm/9½"

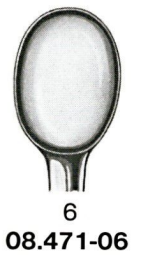
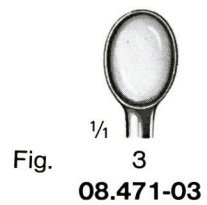
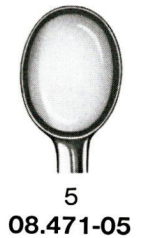
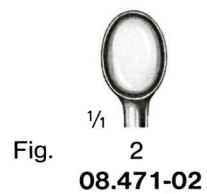
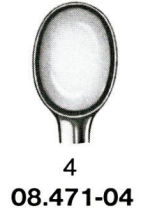
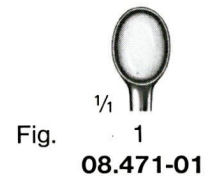

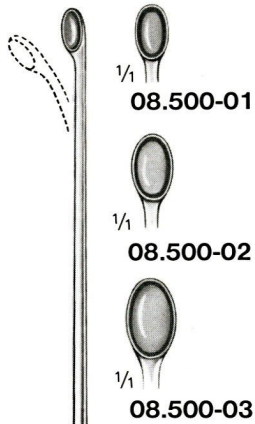

biegsam
 malleable
 malléable
 maleable

Halle
 08.500-01 – 08.500-03
 21 cm/8 1/4"

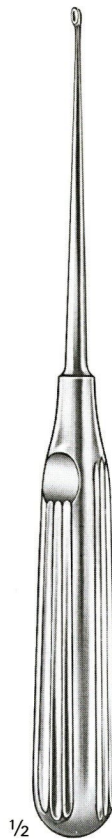

Lempert
 08.502-50 – 08.503-01
 21 cm/8 1/4"

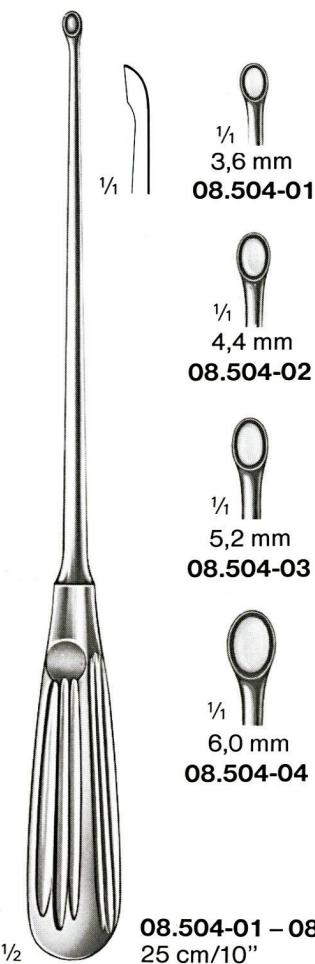
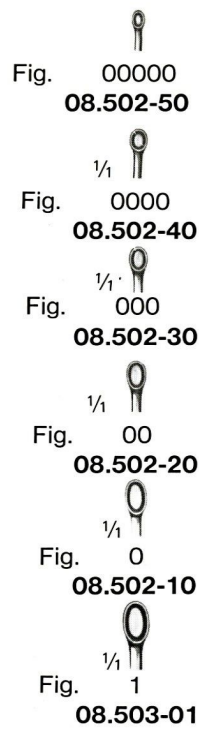

08.504-01 – 08.504-04
 25 cm/10"



08.505-01 – 08.505-04
 25 cm/10"



Schiller
 08.508-26
 26 cm/10 1/4"

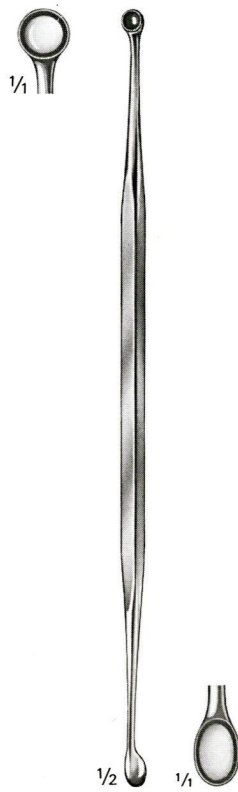

08.517-21
21 cm/8 1/4"

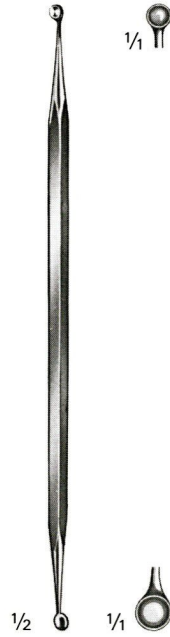

Jansen
54.432-15
16 cm/6 1/4"

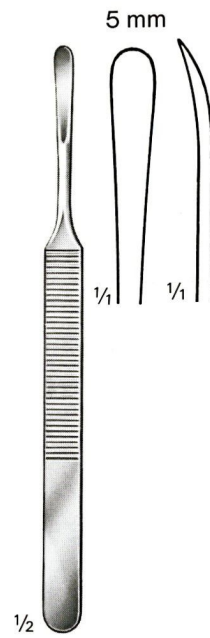

König
08.531-15
15,5 cm/5"

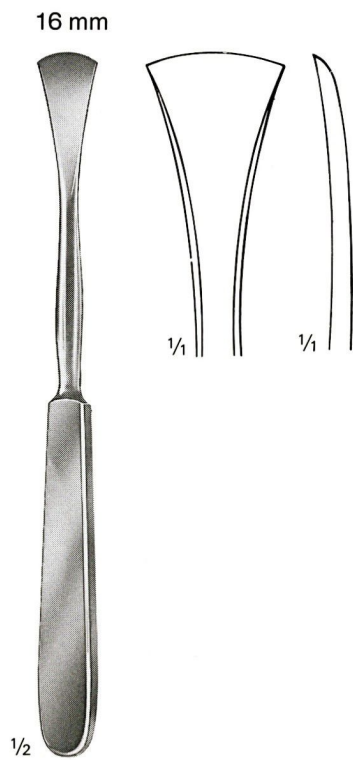

Langenbeck
08.533-19
19 cm/7 1/2"



Cushing
08.540-19
19 cm/7 1/2"

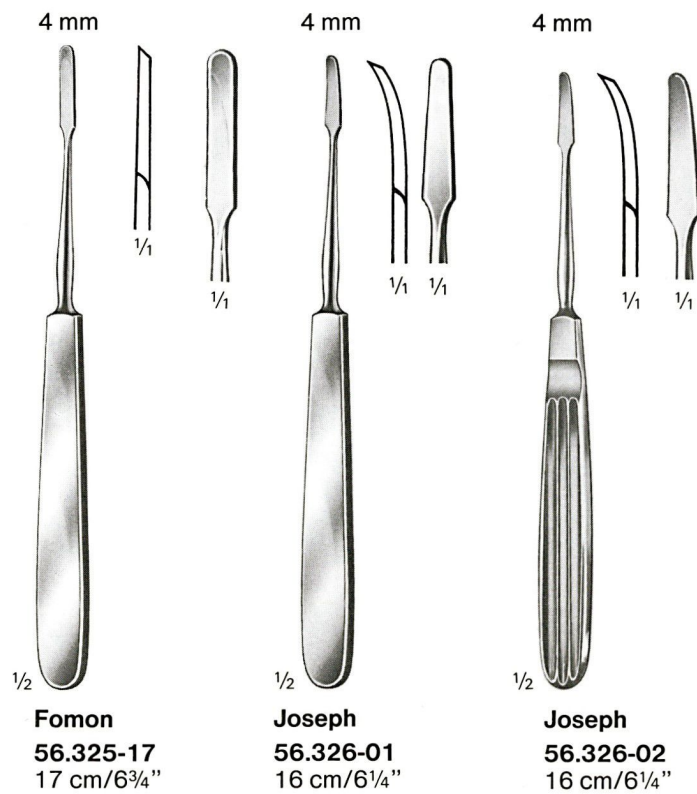
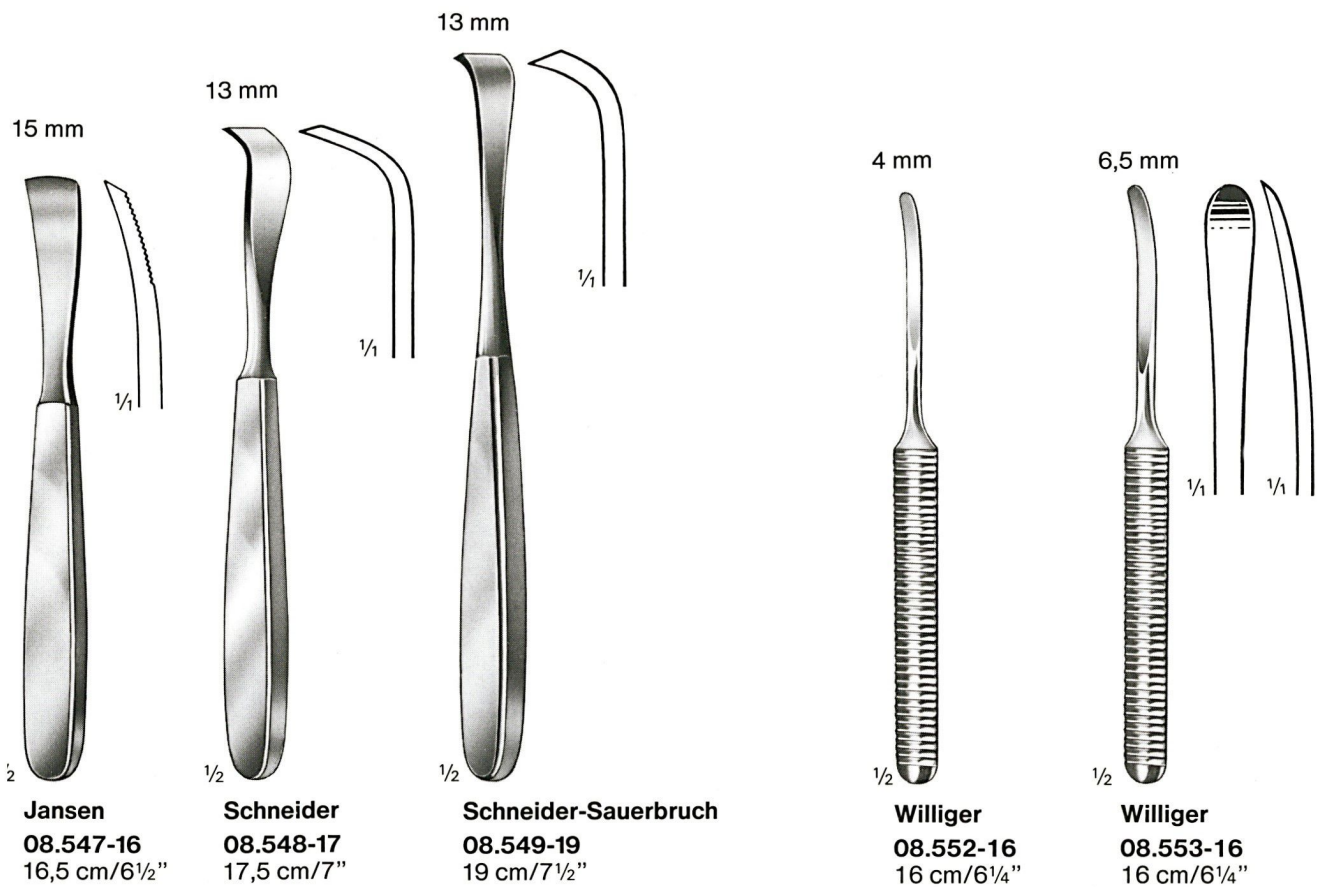

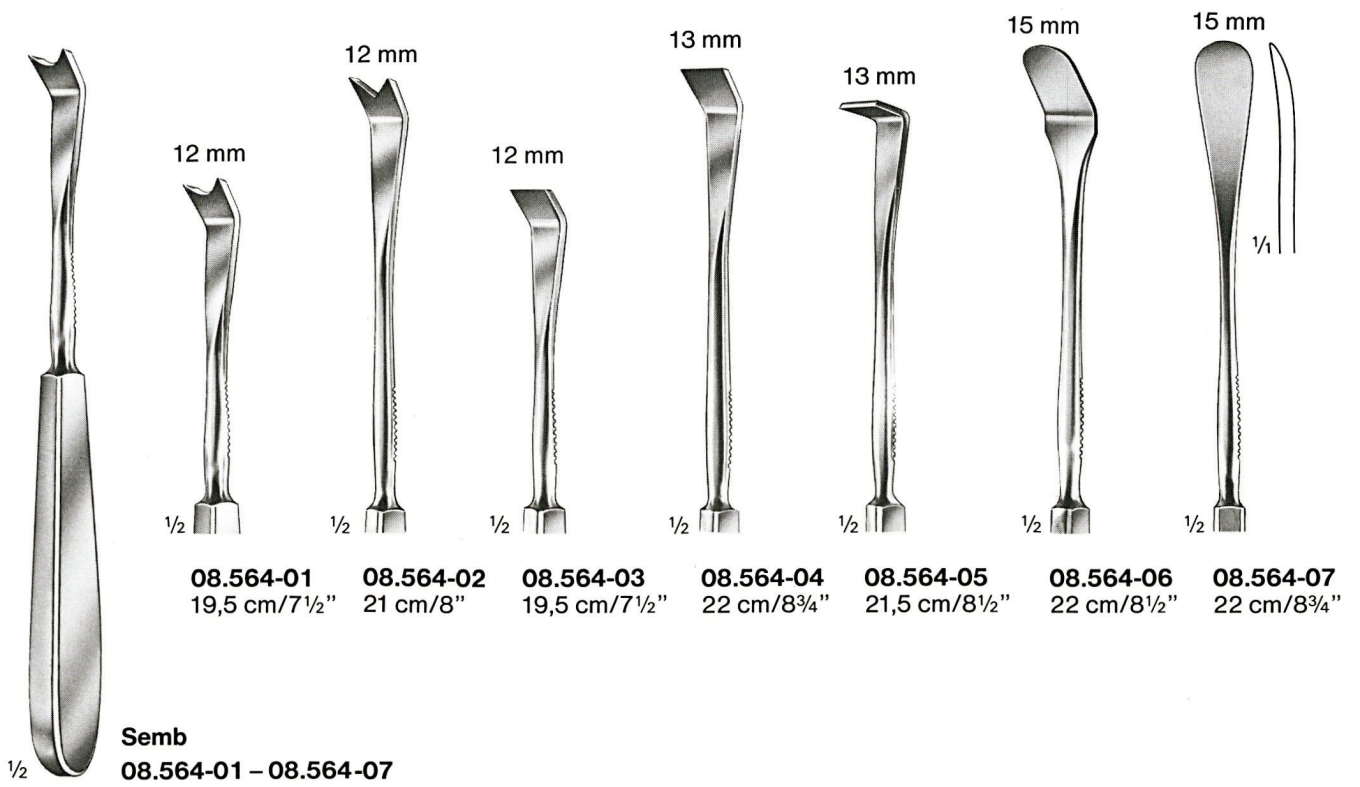

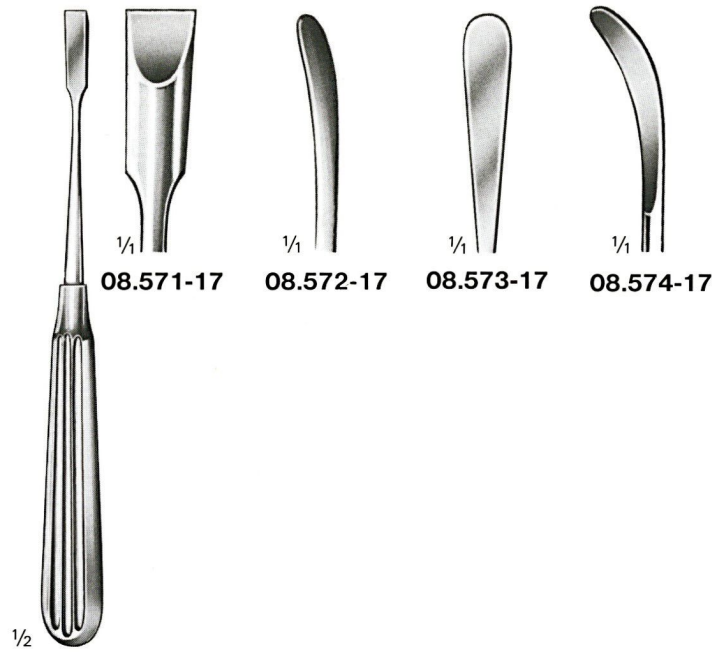

Adson
 08.571-17 – 08.574-17
 17 cm/6³/₄"

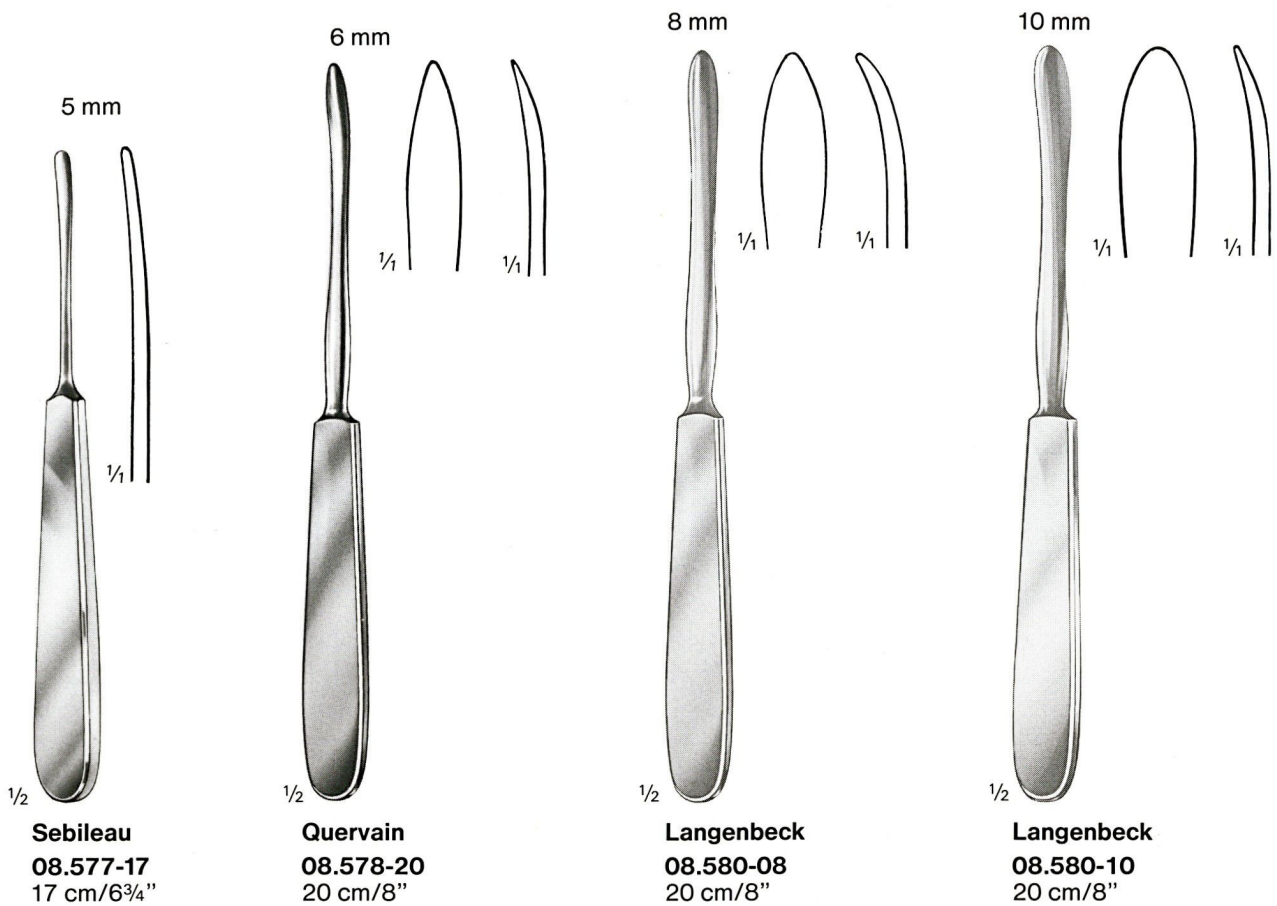

Sebileau
 08.577-17
 17 cm/6³/₄"

Quervain
 08.578-20
 20 cm/8"

Langenbeck
 08.580-08
 20 cm/8"

Langenbeck
 08.580-10
 20 cm/8"

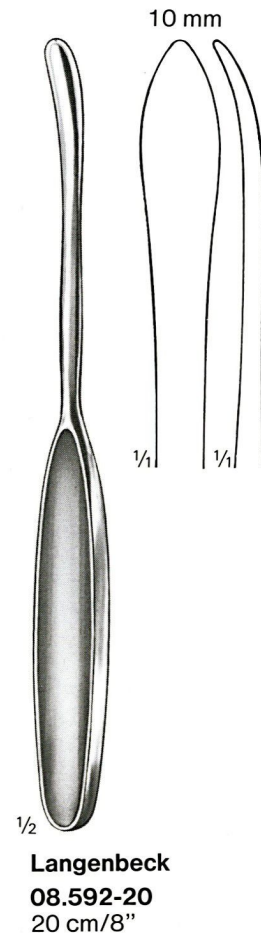
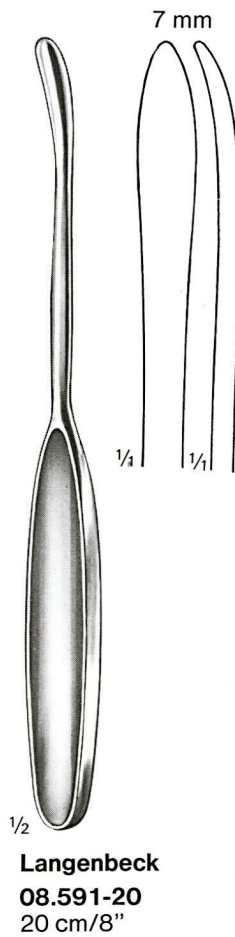
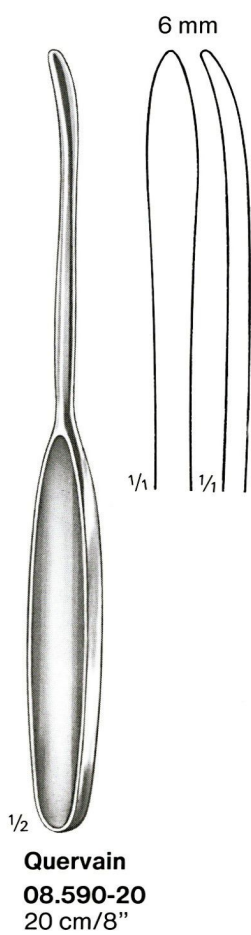
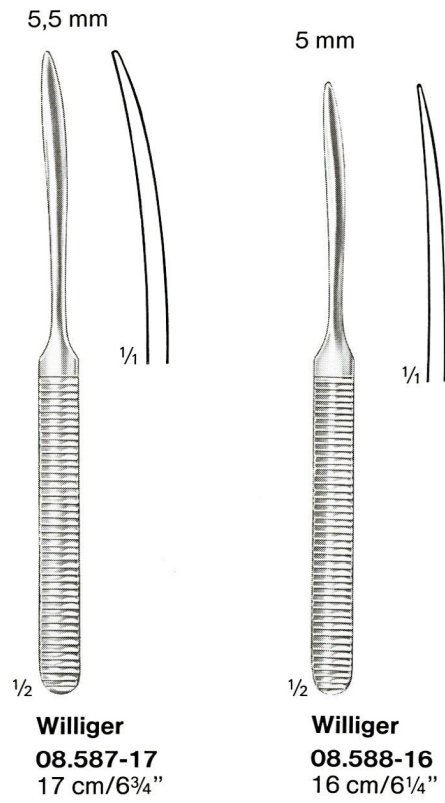

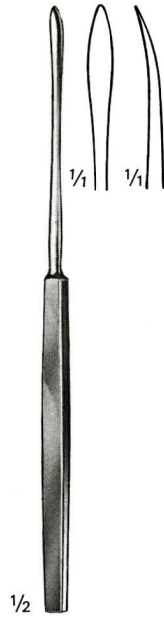

08.594-17
 17,5 cm/6³/₄"

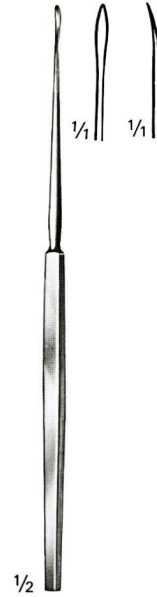

08.595-16
 16 cm/6¹/₄"



Alderdyce
08.599-21
 21 cm/8¹/₄"

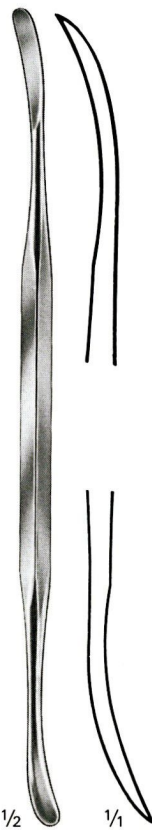

McDonald
08.600-19
 19 cm/7¹/₂"

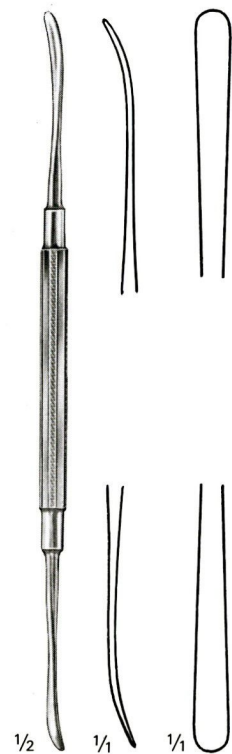

Freer
08.602-18
 18,5 cm/7¹/₄"

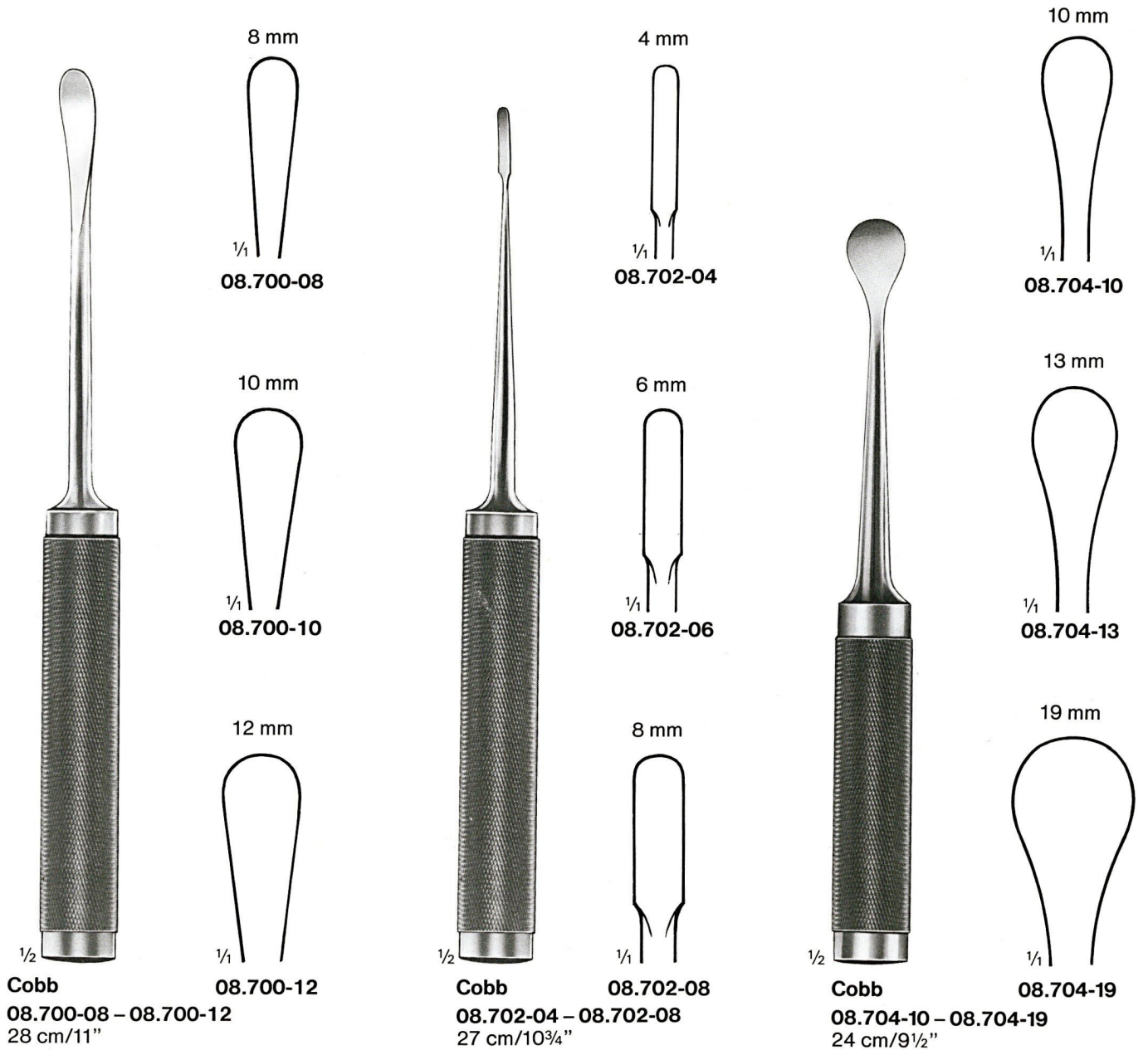

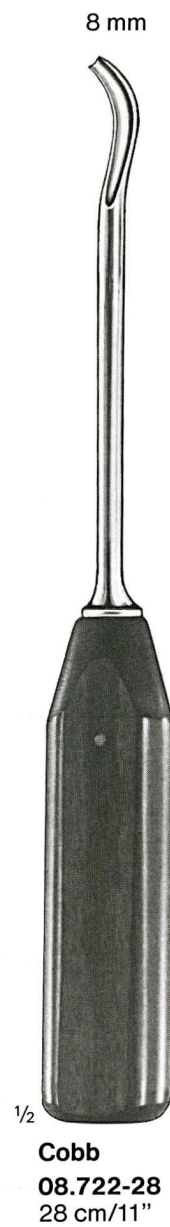
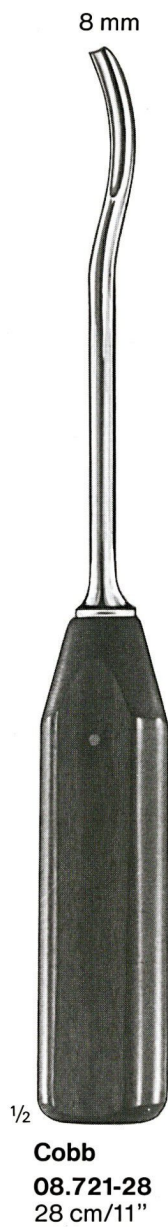
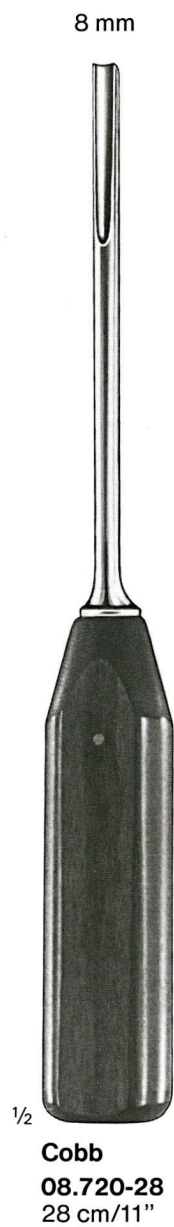

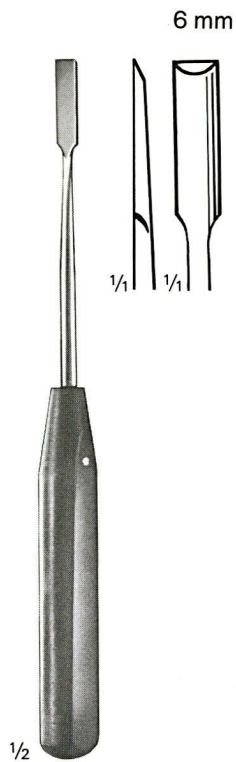

08.800-19
19 cm / 7 1/2"



08.802-18
18,5 cm / 7 1/4"

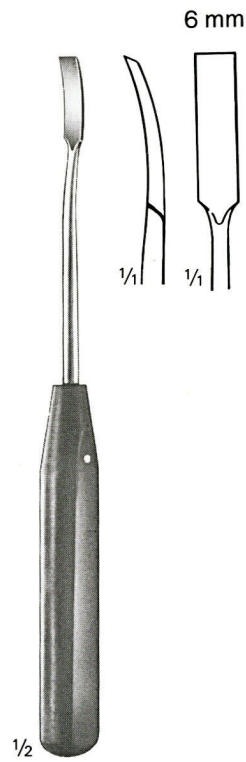

08.804-18
18,5 cm / 7 1/4"

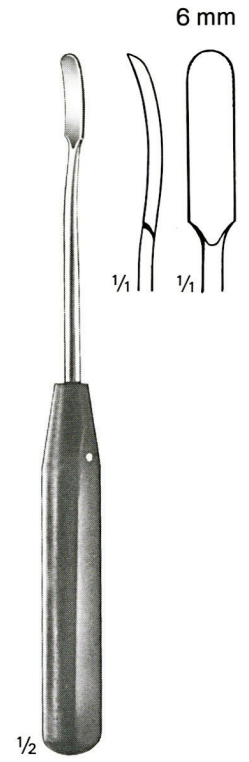

08.806-18
18,5 cm / 7 1/4"

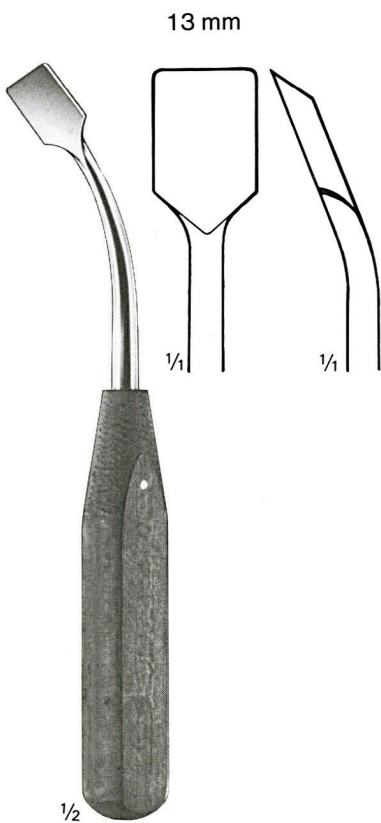

08.808-18
18,5 cm / 7 1/4"

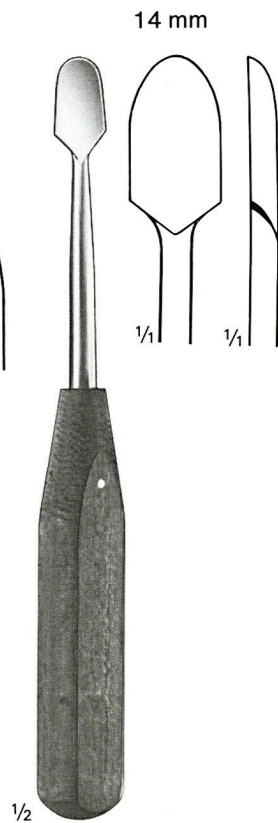

08.810-19
19,5 cm / 7 3/4"

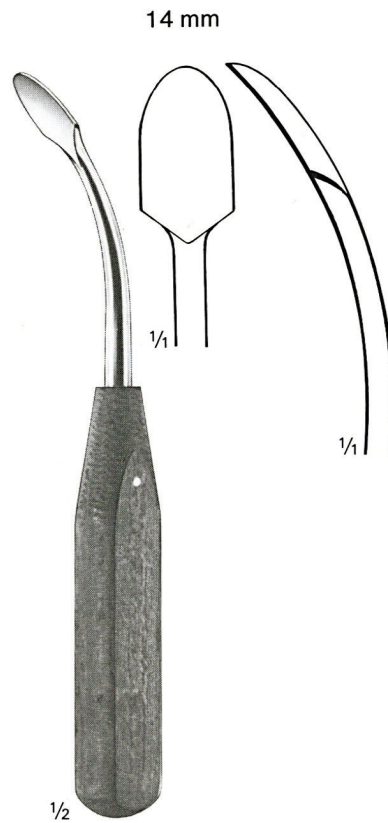

08.812-18
18,5 cm / 7 1/4"

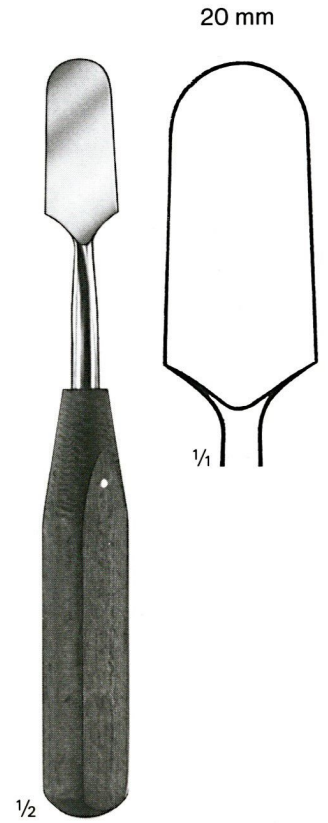

08.814-20
20 cm / 8"

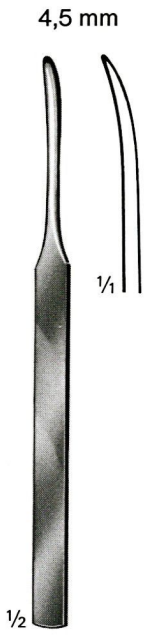

König
08.815-15
 15 cm/6"

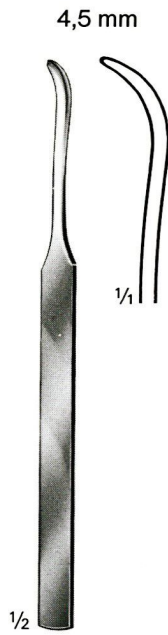

König
08.816-15
 15 cm/6"

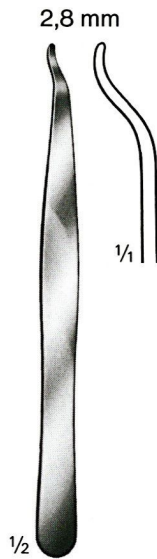

08.830-14
 14 cm/5 1/2"

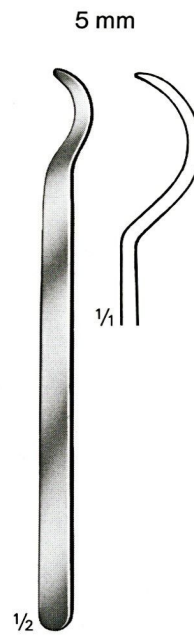

08.832-15
 15 cm/6"

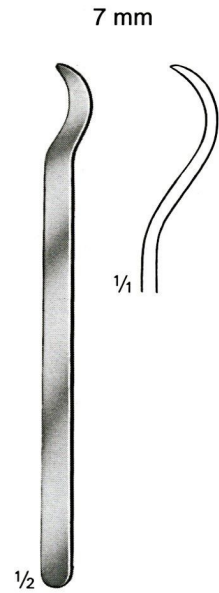

08.834-15
 15 cm/6"

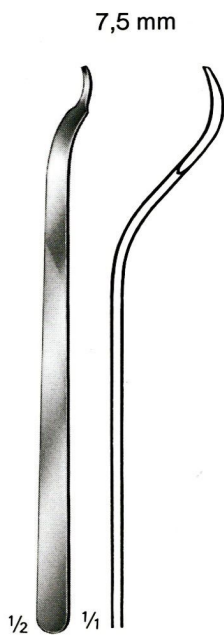

08.837-15
 15 cm/6"

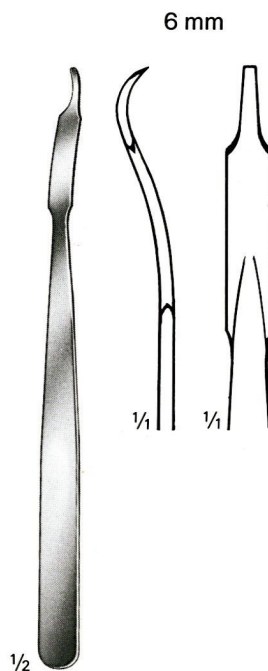

08.838-16
 16 cm/6 1/4"

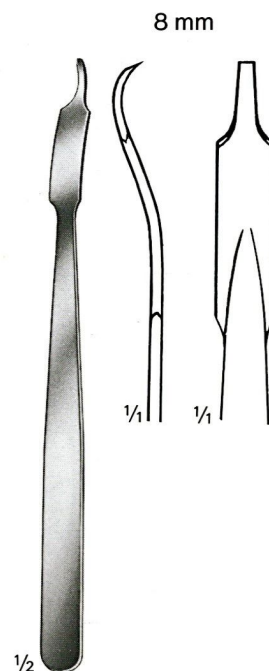

08.839-16
 16 cm/6 1/4"

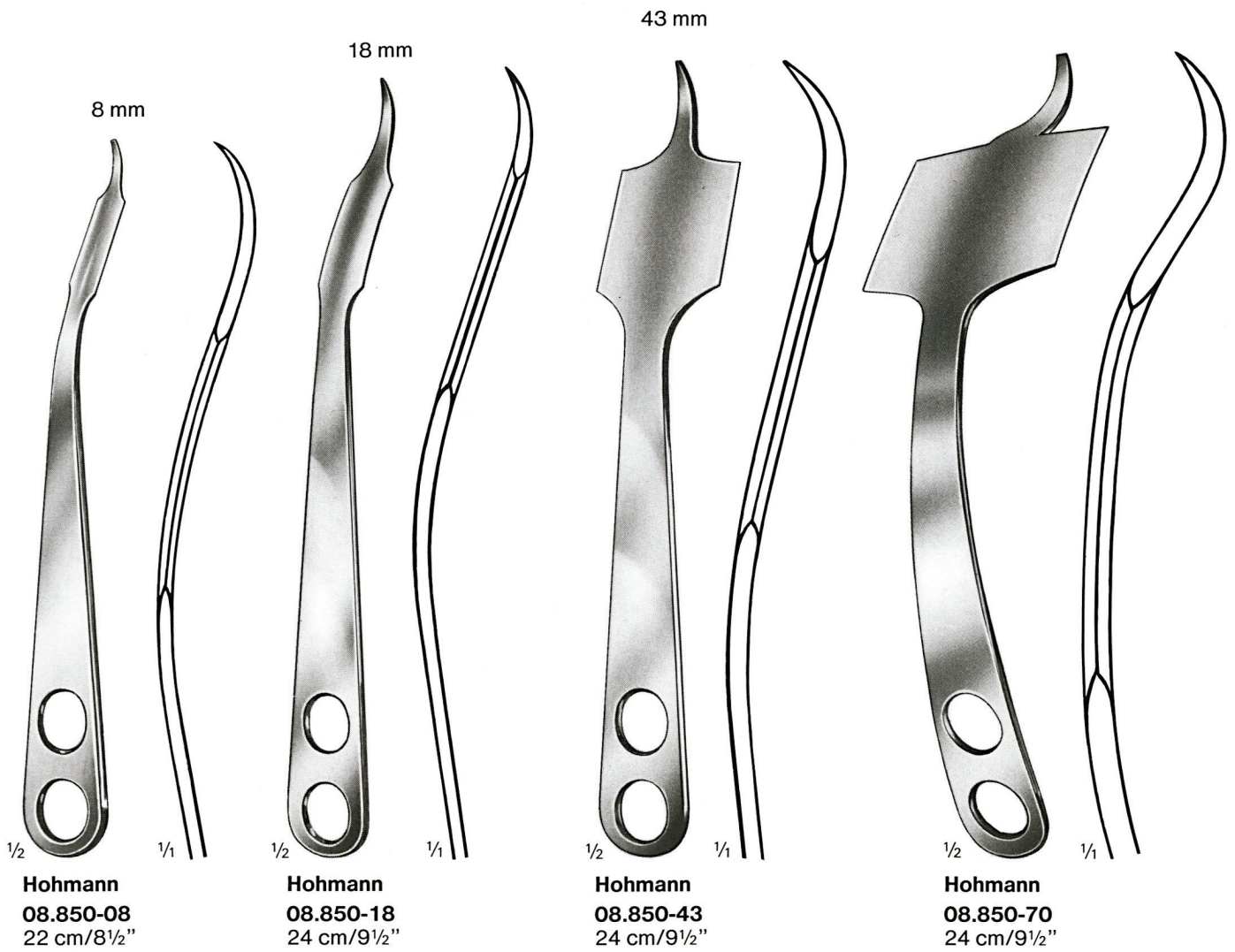

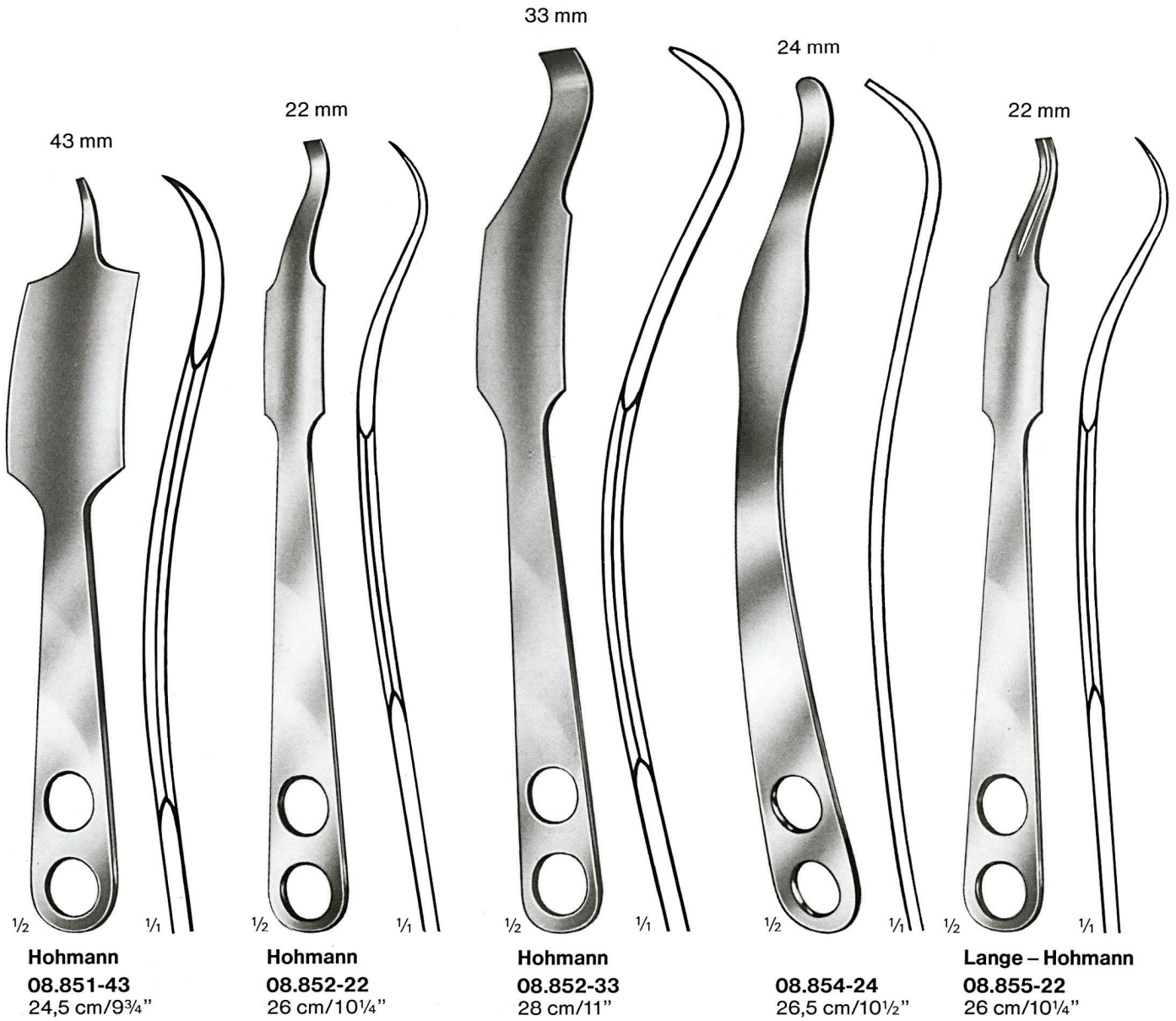

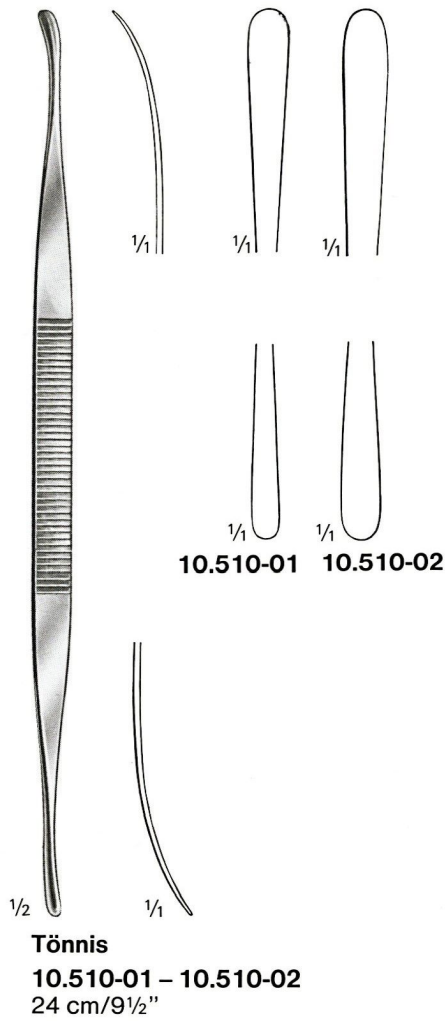

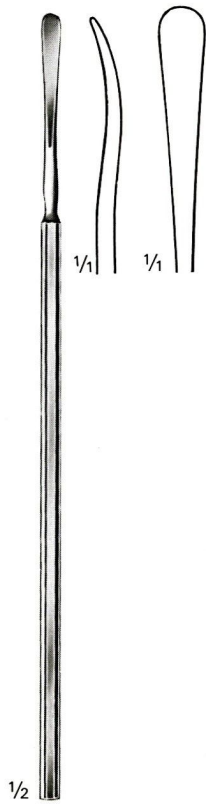

Sachs
10.519-21
 21 cm/8¼"

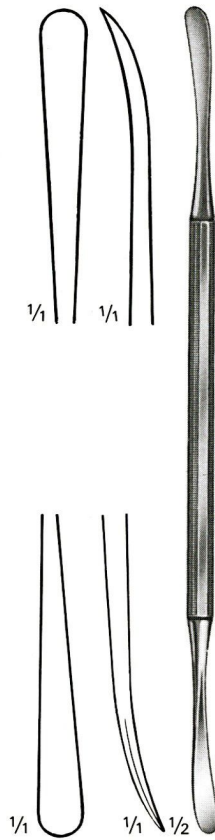

10.520-22
 22 cm/8¾"



Davis
10.522-24
 24,5 cm/9¾"

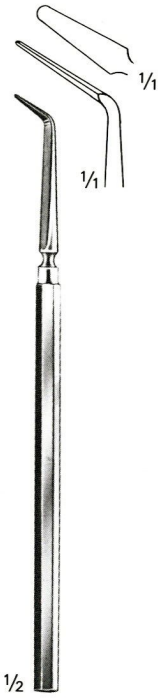

Frazier
10.524-01
15 cm/6"

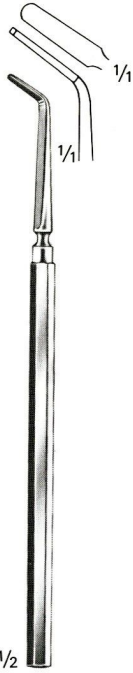

Hoen
10.524-02
15 cm/6"

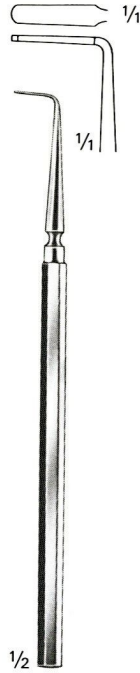

Hoen
10.524-03
15 cm/6"



Love
10.527-19
19,5 cm/8"



Love
10.528-19

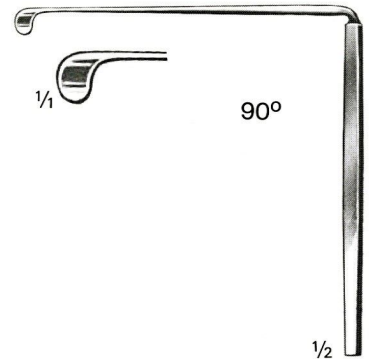

Love
10.529-19

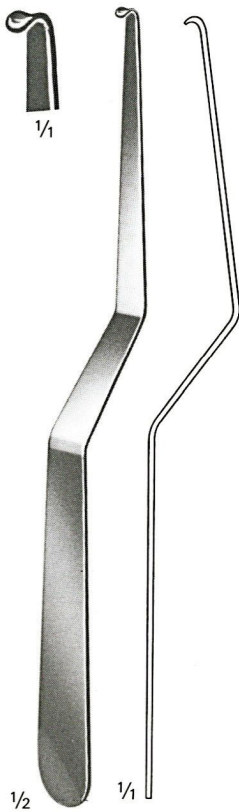

Love
10.531-21
21 cm/8 1/4"

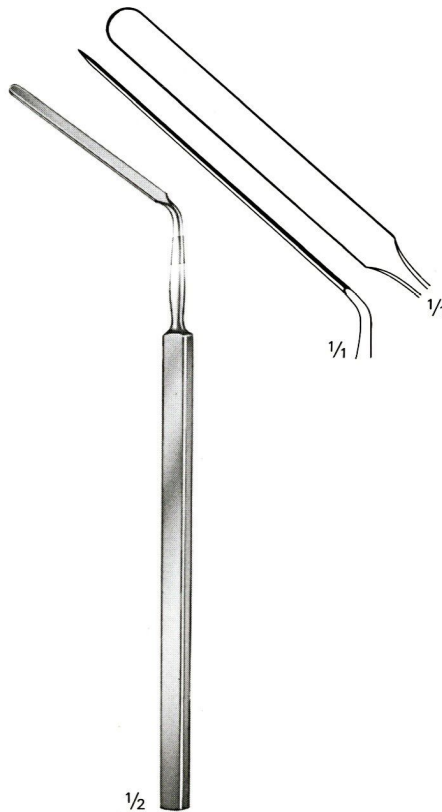

Horsley
10.532-20
20 cm/8"

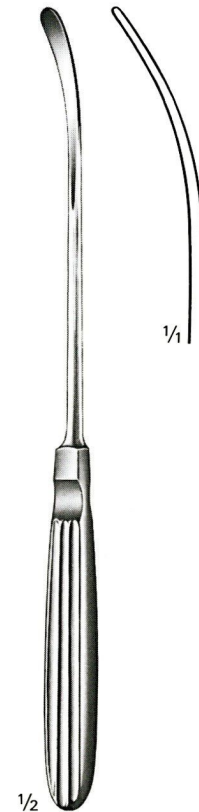

Sachs
10.533-21
21 cm/8 1/2"



Crile
10.534-14
14,5 cm/5 3/4"

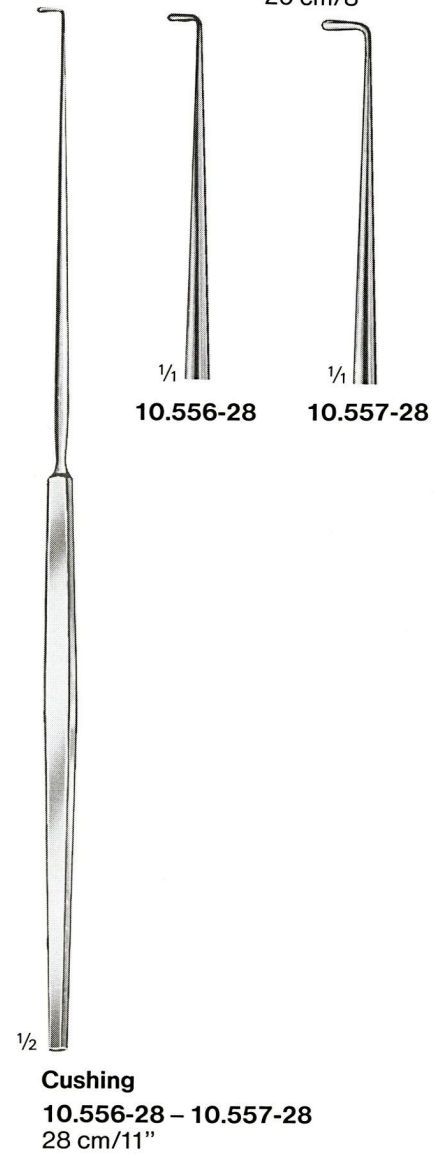
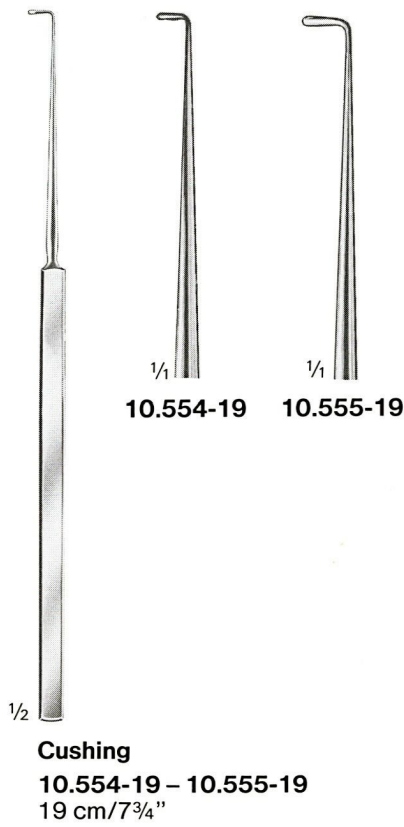
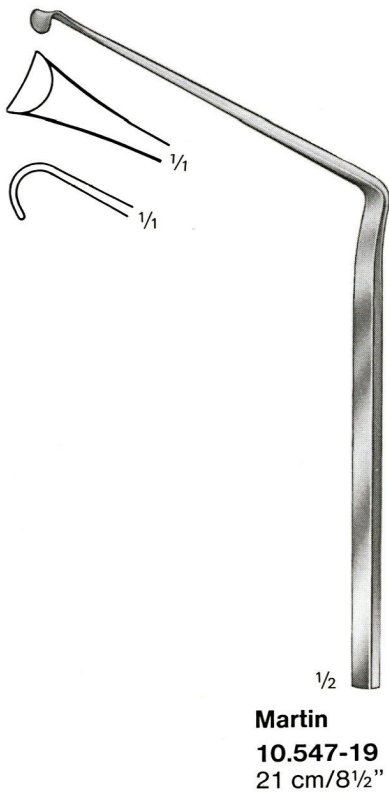
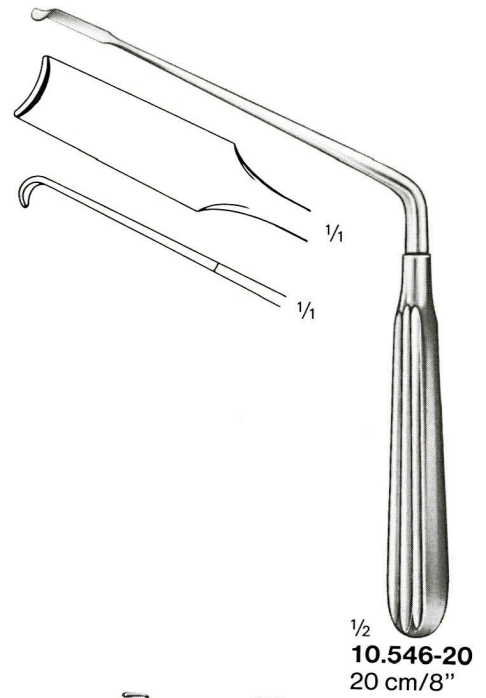
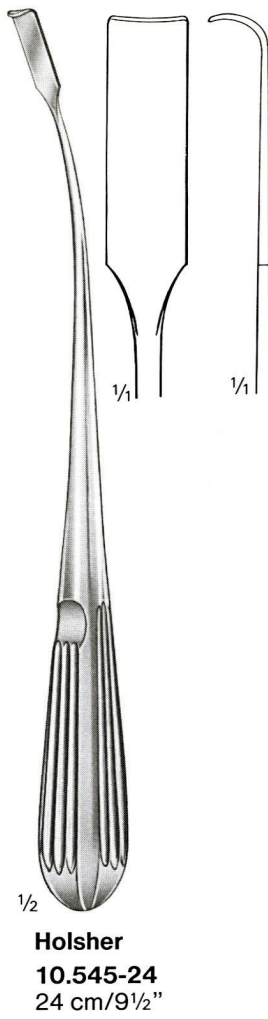



$\frac{1}{2}$
Smithwick
10.558-17
17 cm/6 $\frac{1}{2}$ "
10.558-21
21 cm/8 $\frac{1}{4}$ "

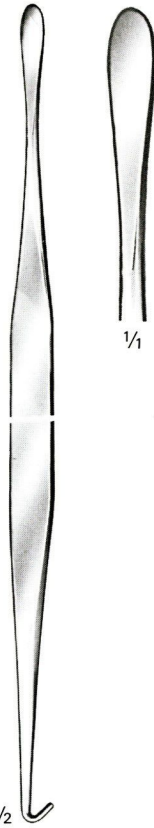

$\frac{1}{2}$
Smithwick
10.561-29
29 cm/11 $\frac{1}{2}$ "

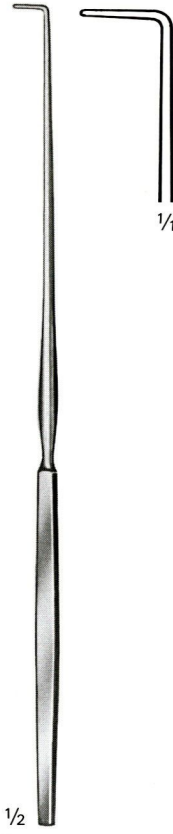

$\frac{1}{2}$
Hoen
10.564-22
22 cm/8 $\frac{3}{4}$ "



$\frac{1}{2}$
Dandy
10.565-20
20 cm/8"



$\frac{1}{2}$
Dandy
10.566-20
20 cm/8"



$\frac{1}{2}$
Dandy
10.567-20
20 cm/8"



$\frac{1}{2}$
Adson
10.587-20
20 cm/8"

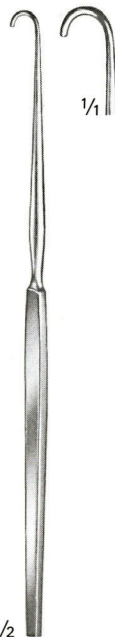

$\frac{1}{2}$
Graham
10.588-16
16,5 cm/6 $\frac{1}{2}$ "



$\frac{1}{2}$
Sachs
10.589-18
18,5 cm/7 $\frac{1}{4}$ "

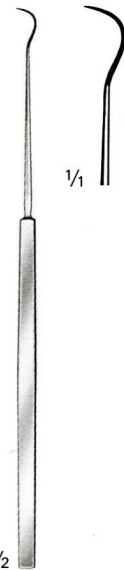

$\frac{1}{2}$
Tönnis
10.590-15
15 cm/6"

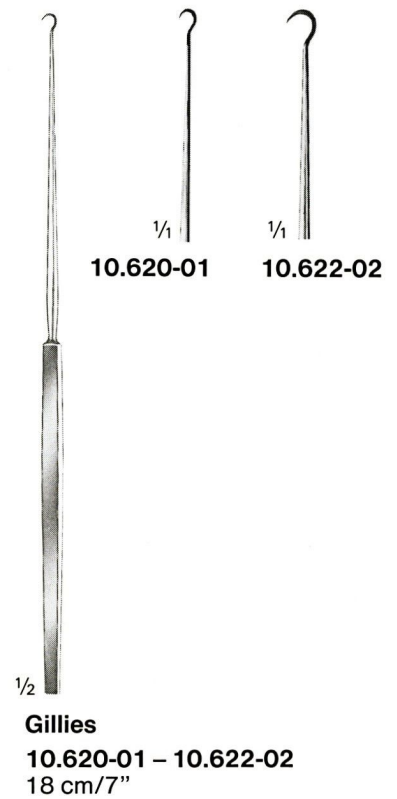
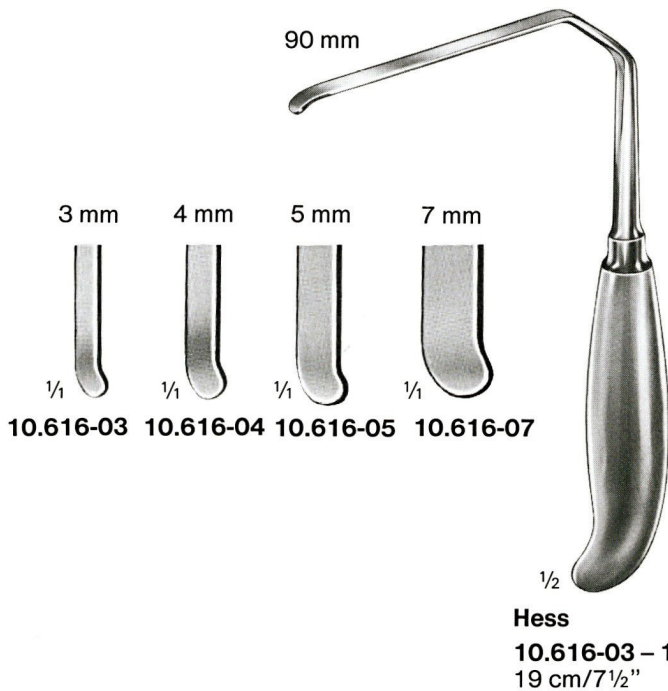
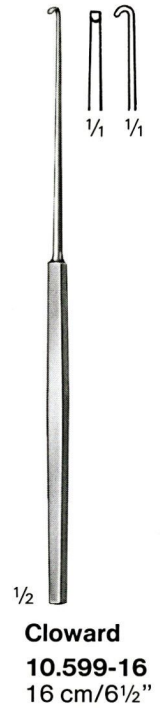
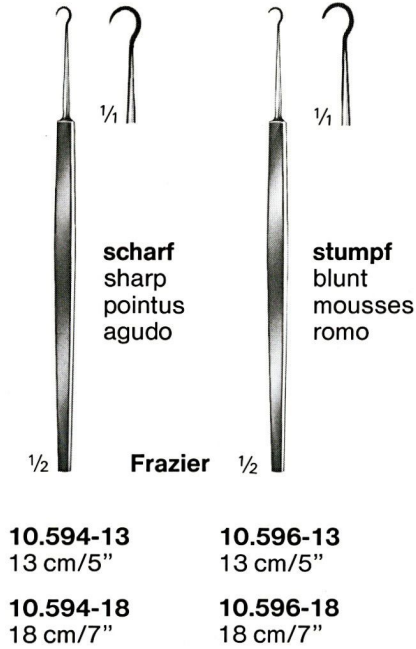
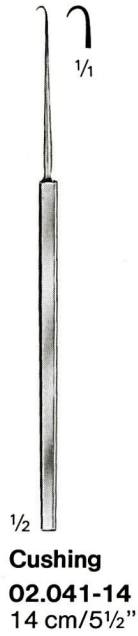



Vidal
18.204-14
14 cm/5 1/2"

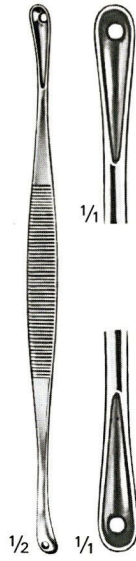

Unna
18.214-14
14 cm/5 1/2"



Saalfeld
18.220-10
10 cm/4"

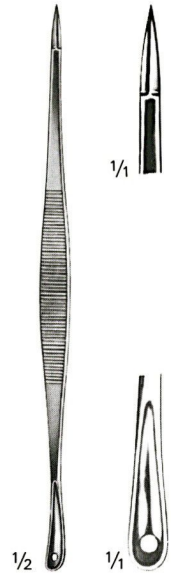

Saalfeld
18.222-14
14 cm/5 1/2"

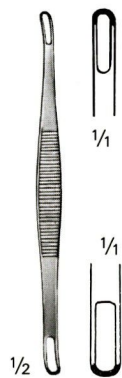

Schamberg
18.224-10
10 cm/4"



Katsch
18.226-14
14 cm/5 1/2"

Gallensteinlöffel, Blasenspatel
Scheidenspekula, Fistelhaken

Gall Stone Scoops,
Bladder Retractors,
Vaginal Speculas,
Fistula Hooks

Curettes pour calculs biliaires,
Ecarteurs à vessie,
Spéculum vaginaux,
Crochets pour fistules

Cucharillas para coger
cálculos biliares,
Separadores vesicales,
Espéculos, Ganchos para
fistulas



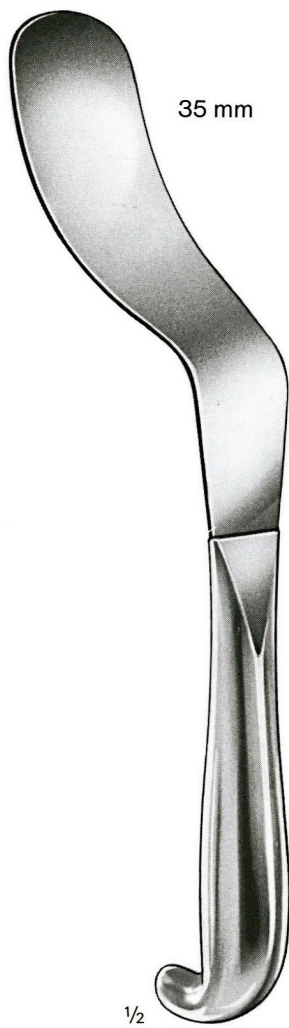

$\frac{1}{2}$
Legue
44.286-27
27 cm/10 $\frac{1}{2}$ "



$\frac{1}{2}$
Kocher
44.287-26
26 cm/10 $\frac{1}{4}$ "

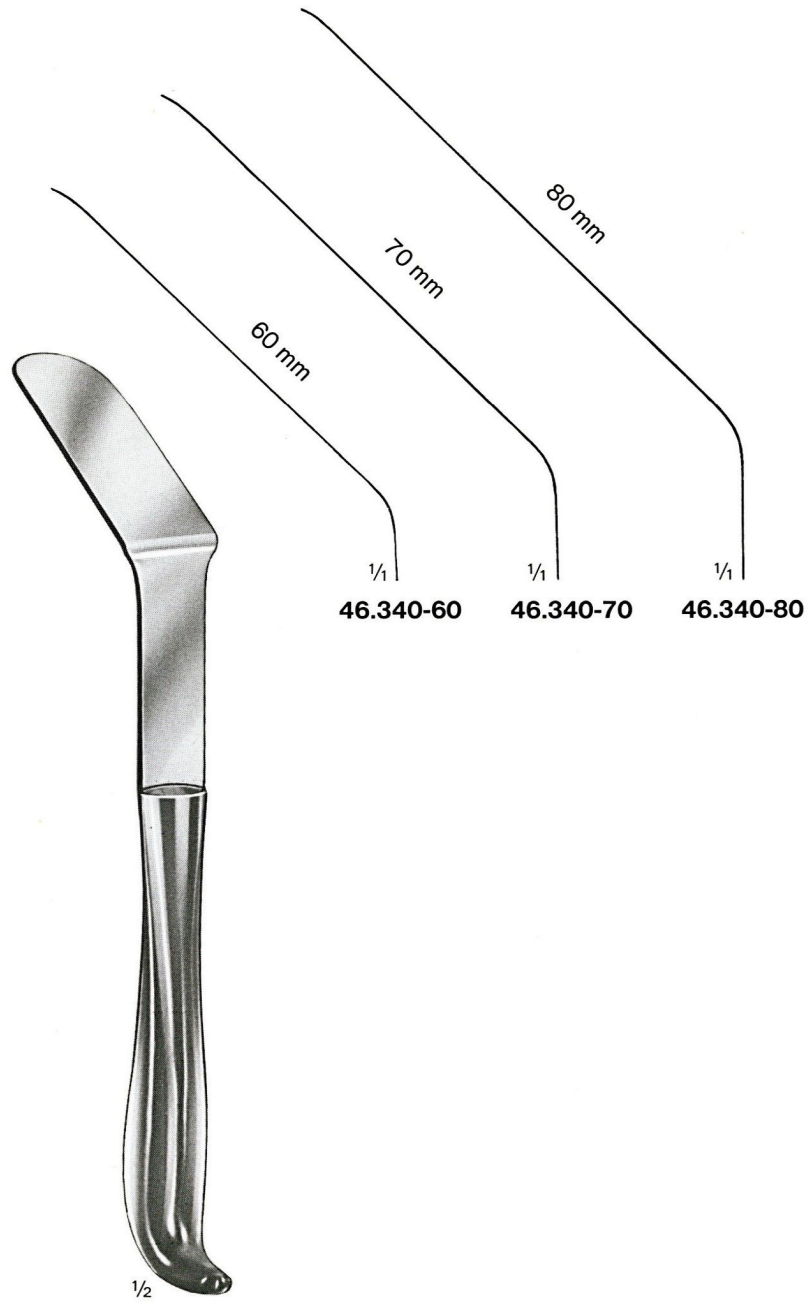

Doyen
46.340-60 – 46.340-80

	cm	in.	
46.340-60	23	9	60 × 30 mm
46.340-70	24	9½	70 × 30 mm
46.340-80	25	10	80 × 30 mm



Doyen

46.304-01 – 46.308-06
24 cm/9½"

Fig.

1	46.304-01	60 × 35 mm
2	46.304-02	90 × 35 mm
3	46.304-03	120 × 35 mm
4	46.304-04	140 × 35 mm
5	46.304-05	160 × 35 mm
6	46.304-06	180 × 35 mm
1	46.306-01	60 × 45 mm
2	46.306-02	90 × 45 mm
3	46.306-03	120 × 45 mm
4	46.306-04	140 × 45 mm
5	46.306-05	160 × 45 mm
6	46.306-06	180 × 45 mm
1	46.308-01	60 × 60 mm
2	46.308-02	90 × 60 mm
3	46.308-03	120 × 60 mm
4	46.308-04	140 × 60 mm
5	46.308-05	160 × 60 mm
6	46.308-06	180 × 60 mm

Doyen

46.314-01 – 46.318-04
24 cm/9½"

Fig.

1	46.314-01	60 × 35 mm
2	46.314-02	90 × 35 mm
3	46.314-03	120 × 35 mm
4	46.314-04	130 × 35 mm
1	46.316-01	60 × 45 mm
2	46.316-02	90 × 45 mm
3	46.316-03	120 × 45 mm
4	46.316-04	130 × 45 mm
1	46.318-01	60 × 60 mm
2	46.318-02	90 × 60 mm
3	46.318-03	120 × 60 mm
4	46.318-04	130 × 60 mm



Breisky

46.320-20 – 46.320-40
 29 cm/11½"

46.320-20	100 × 20 mm
46.320-25	100 × 25 mm
46.320-30	100 × 30 mm
46.320-35	100 × 35 mm
46.320-40	100 × 40 mm

Breisky

46.322-20 – 46.322-40
 32 cm/12½"

46.322-20	130 × 20 mm
46.322-25	130 × 25 mm
46.322-30	130 × 30 mm
46.322-35	130 × 35 mm
46.322-40	130 × 40 mm

Breisky

46.324-20 – 46.324-40
 35 cm/13¾"

46.324-20	160 × 20 mm
46.324-25	160 × 25 mm
46.324-30	160 × 30 mm
46.324-35	160 × 35 mm
46.324-40	160 × 40 mm

Breisky

46.326-20 – 46.326-40
 37 cm/14¼"

46.326-20	180 × 20 mm
46.326-25	180 × 25 mm
46.326-30	180 × 30 mm
46.326-35	180 × 35 mm
46.326-40	180 × 40 mm

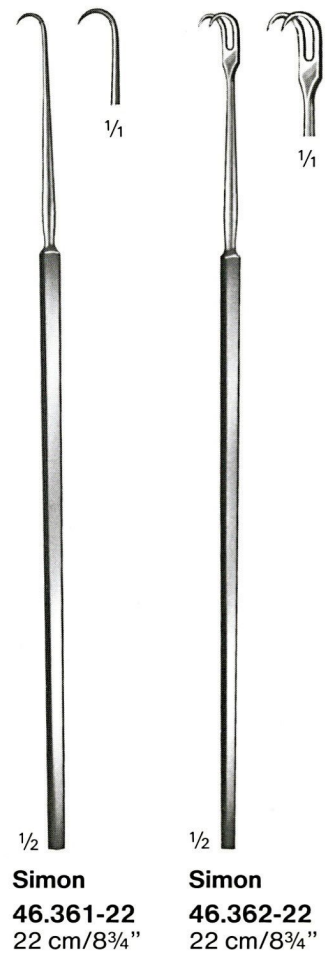
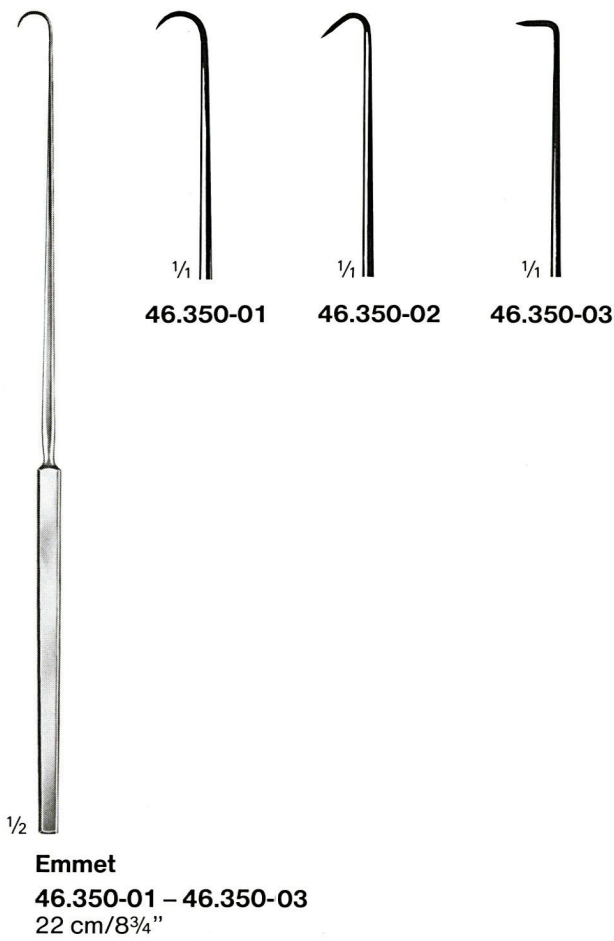

Ophthalmologie
Ophthalmology
Ophthalmologie
Oftalmologia

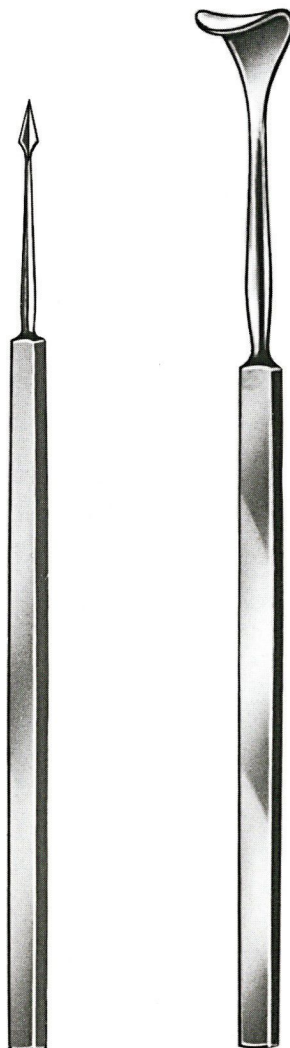

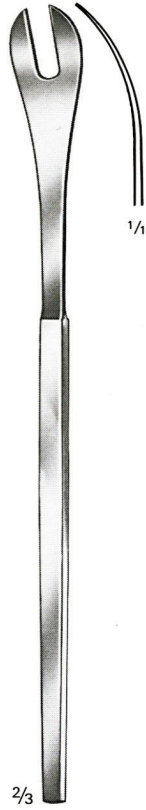

$\frac{2}{3}$
Schepens
50.246-13
13 cm/5"



$\frac{2}{3}$
Conway
50.250-08
13 cm/5"



$\frac{2}{3}$
Desmarres
50.250-10
13 cm/5"



$\frac{2}{3}$
Desmarres
50.250-12 – 50.250-18
13 cm/5"

12 mm



$\frac{1}{4}$

50.250-12

14 mm



$\frac{1}{4}$

50.250-14

16 mm

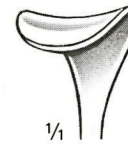

$\frac{1}{4}$

50.250-16

18 mm



$\frac{1}{4}$

50.250-18

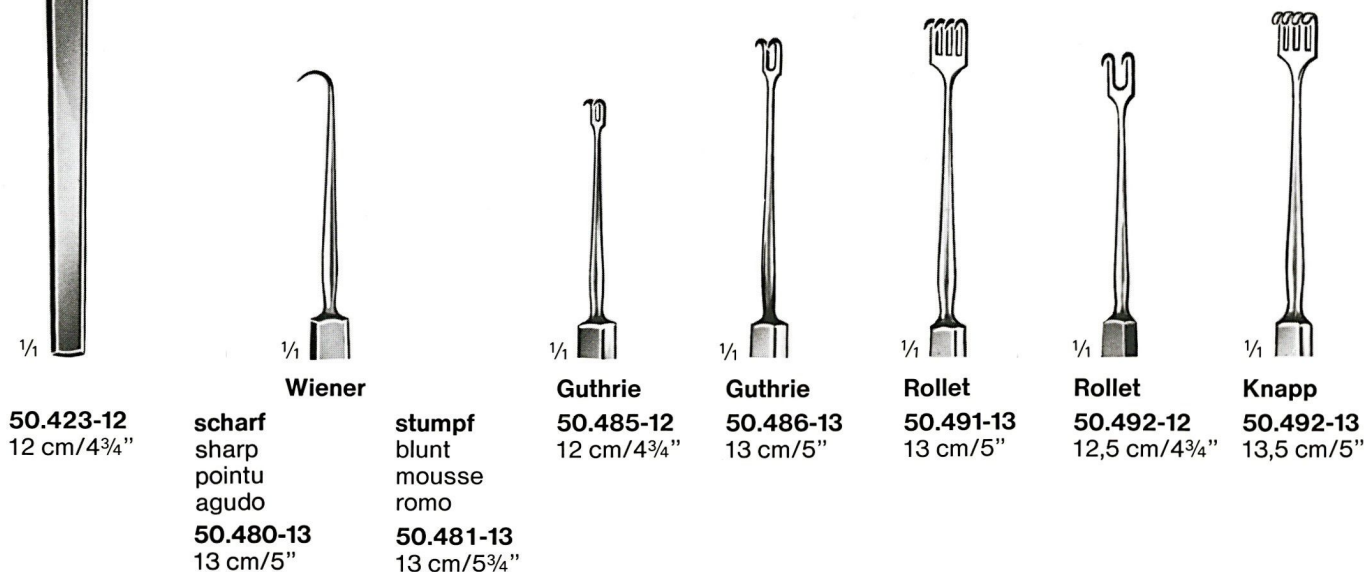
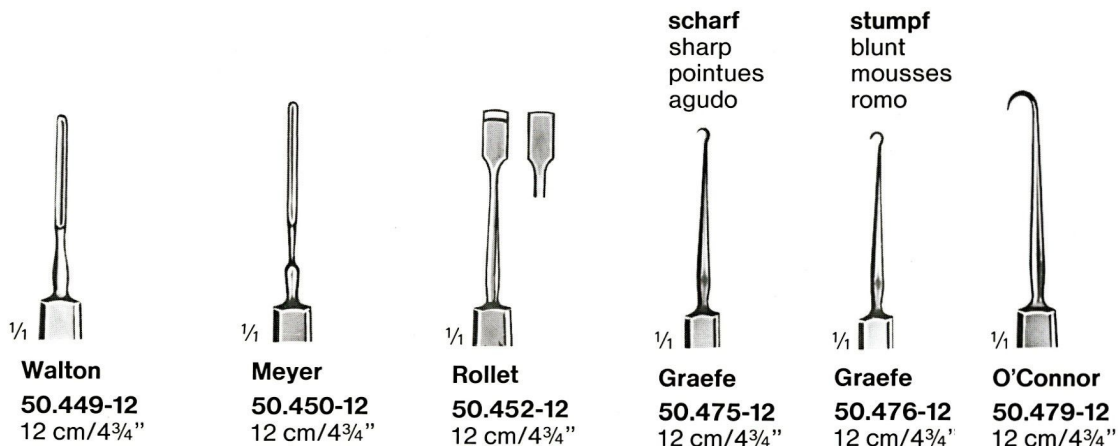
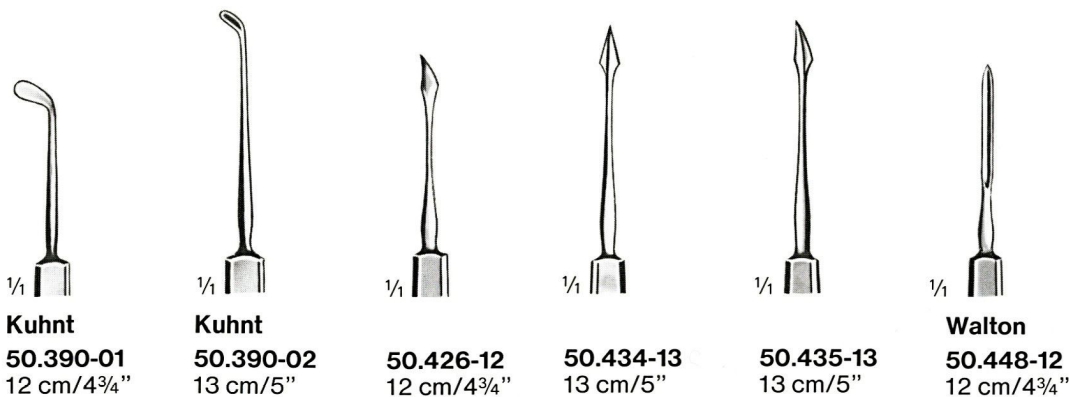



Carroll
50.494-12
12 cm/4³/₄"



Knapp-Rollet
50.496-13
13 cm/5"



Knapp-Rollet
50.497-13
13 cm/5"



Knapp-Rollet
50.498-13
13 cm/5"



1/4

Axenfeld

scharf **stumpf**
sharp blunt
pointus mousses
agudo romo

50.500-14 **50.501-14**
14 cm/5¹/₂" 14 cm/5¹/₂"



Jameson
50.510-13
13 cm/5"



Graefe
50.515-13
13 cm/5"



Graefe
50.515-14
14 cm/5¹/₂"



Graefe
50.515-15
15 cm/6"



Jaeger
50.518-02
13 cm/5"



Lewis
50.565-14
14 cm/5¹/₂"



Lewis
50.566-14
14 cm/5¹/₂"



Weber
50.568-14
14 cm/5¹/₂"



New Orleans
50.569-13
13 cm/5"



Snellen
50.571-13
13 cm/5"



1/4

Arlt

glatt **gerieft**
smooth serrated
lisse striée
lisa estriada

50.572-13 **50.573-13**
13 cm/5" 13 cm/5"

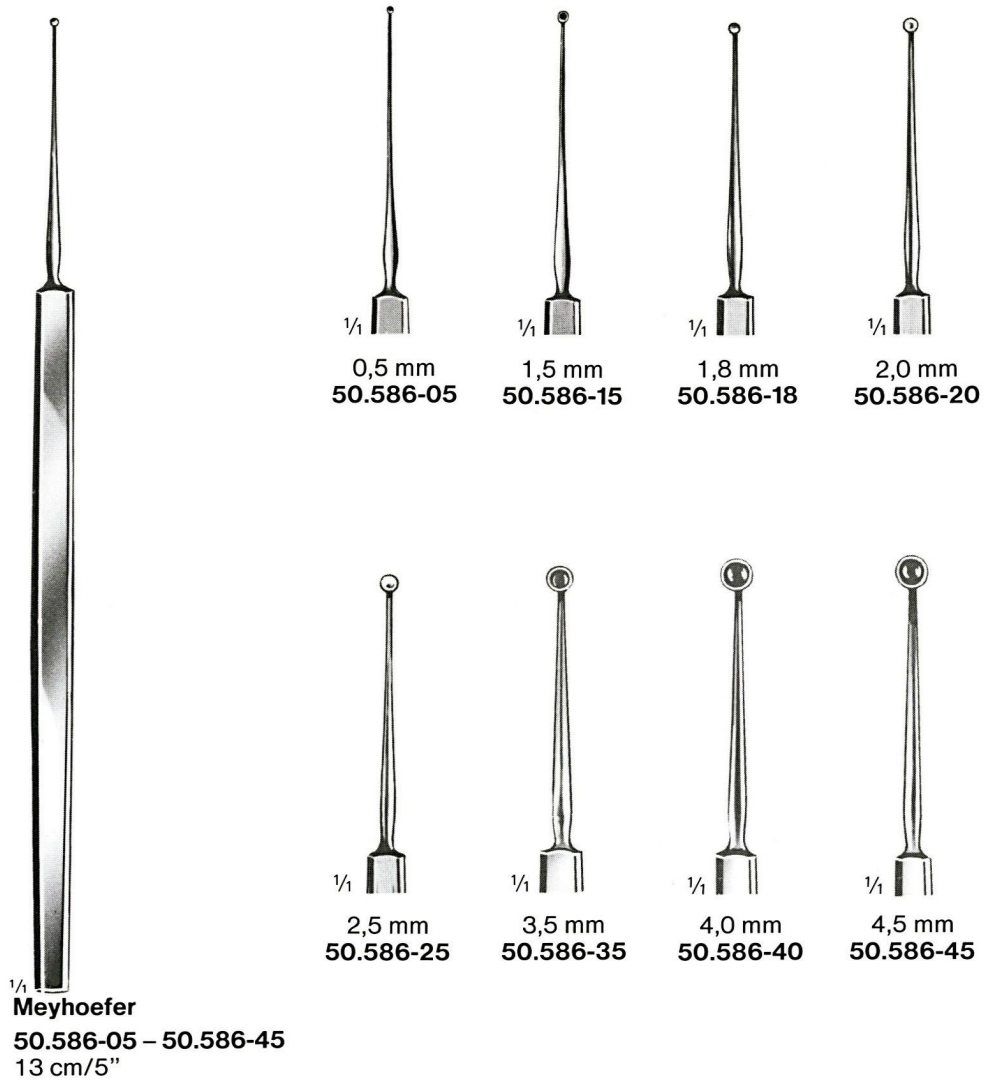

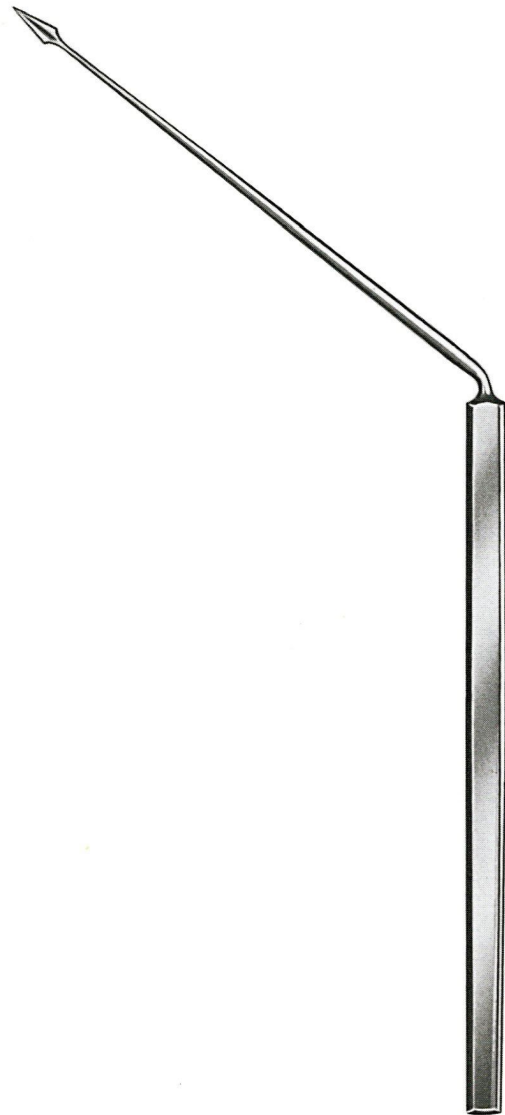

Otologie
Otology
Otologie
Otología



1/2



stumpf
 blunt
 mousses
 romo

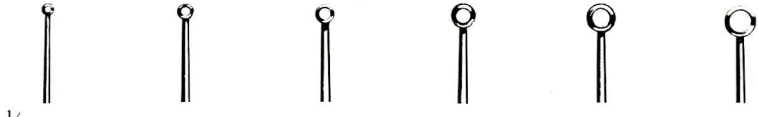

1/4
 000 00 0 1 2 3
54.382-01 54.382-02 54.382-10 54.382-11 54.382-12 54.382-13



scharf
 sharp
 pointues
 agudo

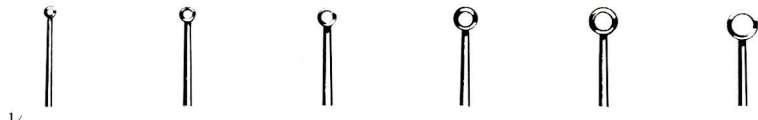

1/4
 000 00 0 1 2 3
54.384-01 54.384-02 54.384-10 54.384-11 54.384-12 54.384-13

Buck

54.382-01 – 54.384-13
 16,5 cm/6 1/2"



1/2



stumpf
 blunt
 mousses
 romo



1/4
 000 00 0 1 2 3
54.386-01 54.386-02 54.386-10 54.386-11 54.386-12 54.386-13



scharf
 sharp
 pointues
 agudo



1/4
 000 00 0 1 2 3
54.388-01 54.388-02 54.388-10 54.388-11 54.388-12 54.388-13

Buck

54.386-01 – 54.388-13
 16,5 cm/6 1/2"

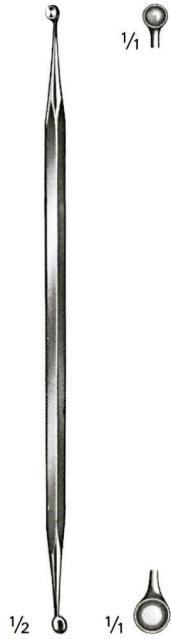

Jansen
54.432-15
16 cm/6 1/4"



Shapleigh
54.438-01 – 54.438-04
13 cm/5 1/4"

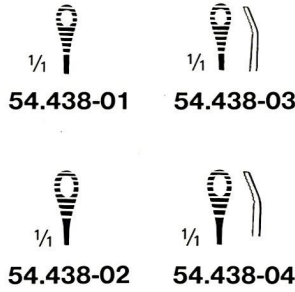

54.389-01
16 cm/6 1/4"



54.389-02
16 cm/6 1/4"

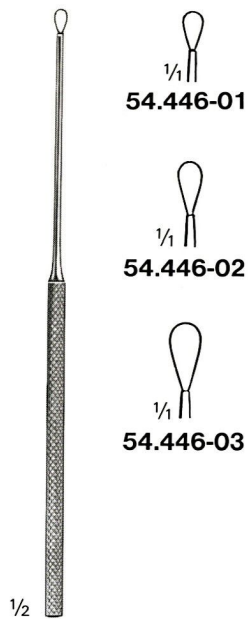

Billeau
54.446-01 – 54.446-03
16,5 cm/6 1/2"



Zaufal
54.450-16
16 cm/6 1/2"
54.450-20
20 cm/8"



Hartmann
54.452-16
16 cm/6 1/2"

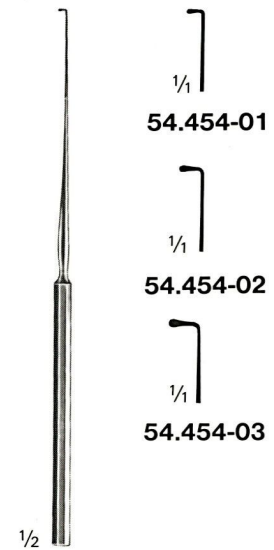

Lucae
54.454-01 – 54.454-03
14 cm/5 1/2"

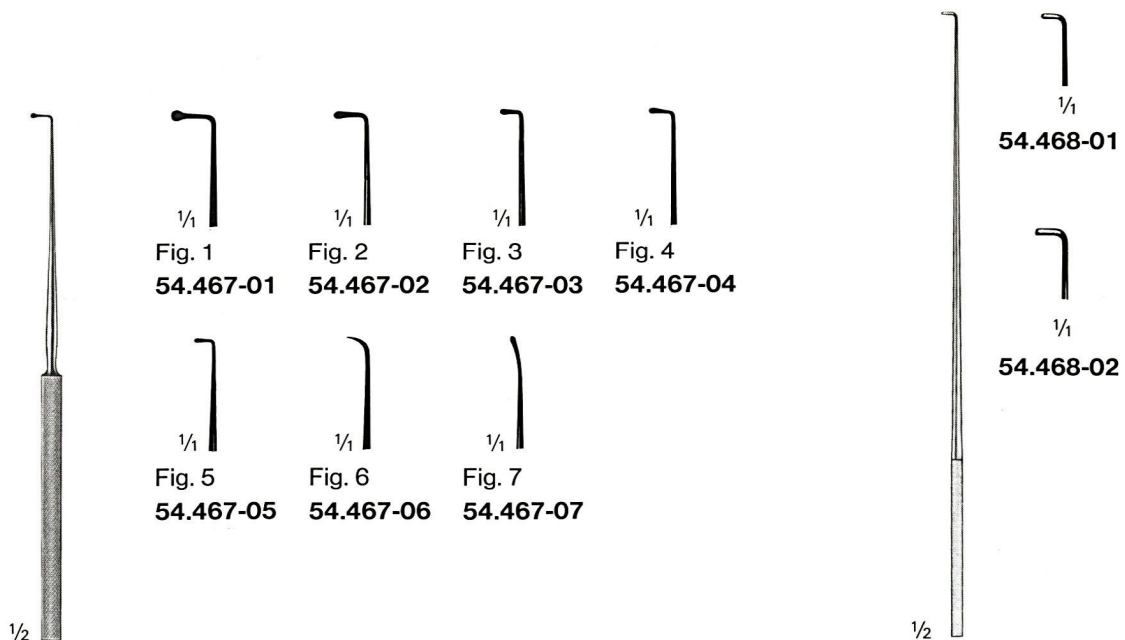

Wagener
 54.467-01 – 54.467-07
 14 cm/5½"

Day
 54.468-01 – 54.468-02
 16 cm/6½"

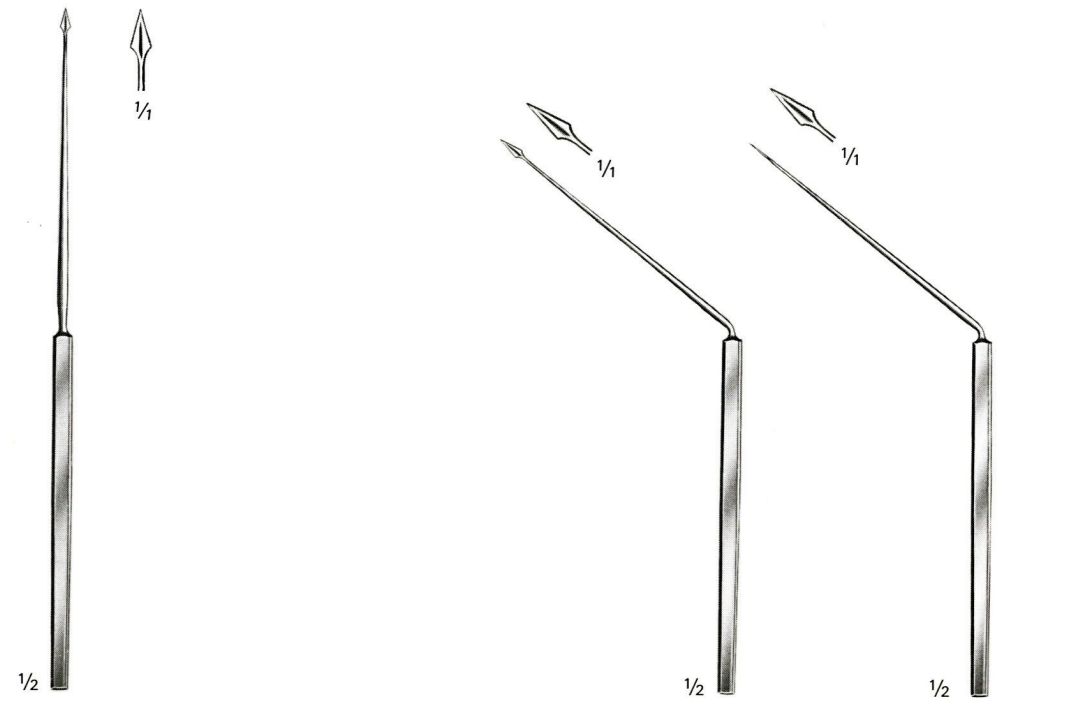

Politzer
 54.495-16
 16 cm/6½"

Politzer
 54.496-16
 16 cm/6½"

Politzer
 54.497-16
 16 cm/6½"

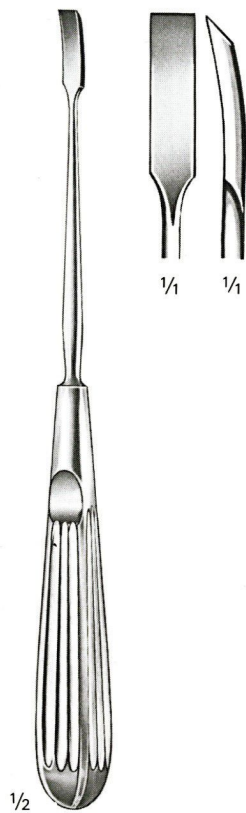

$\frac{1}{2}$
Lempert
54.553-20
20,5 cm/8"

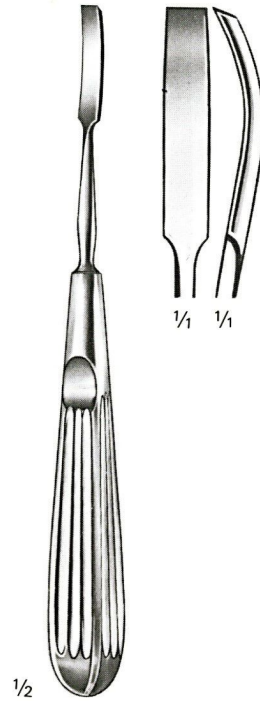

$\frac{1}{2}$
Lempert
54.554-17
18 cm/7 $\frac{1}{4}$ "

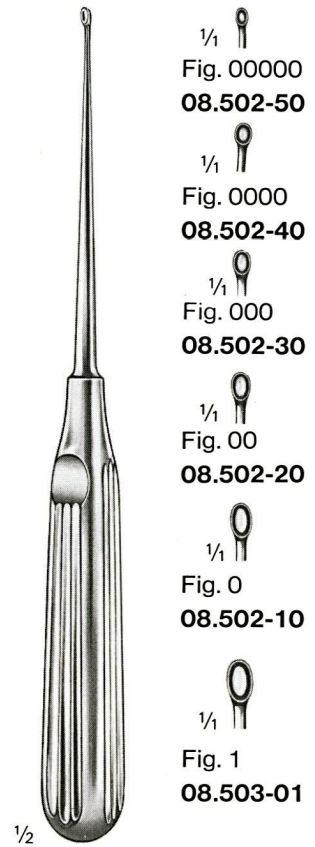

$\frac{1}{2}$
Lempert
08.502-50 – 08.503-01
21 cm/8 $\frac{1}{4}$ "

- $\frac{1}{1}$
Fig. 00000
08.502-50
- $\frac{1}{1}$
Fig. 0000
08.502-40
- $\frac{1}{1}$
Fig. 000
08.502-30
- $\frac{1}{1}$
Fig. 00
08.502-20
- $\frac{1}{1}$
Fig. 0
08.502-10
- $\frac{1}{1}$
Fig. 1
08.503-01

Rhinologie,
Zungenspatel,
Tonsillenelevatorien,-haken

Rhinology,
Tongue Depressors,
Tonsil Elevators, -Retractors

Rhinologie,
Abaisse-langues,
Élévateurs et écarteurs pour
amygdales

Rinología,
Abaja-lenguas,
Elevadores y Separadores para
amígdalas

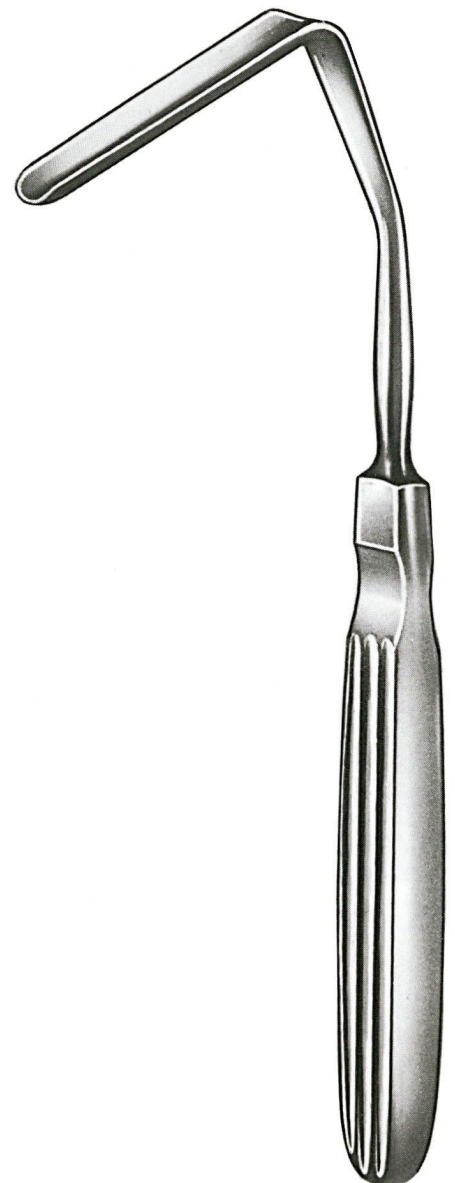



Freer
56.312-01
19 cm/7 1/2"



Freer
56.312-02
19 cm/7 1/2"



Freer
56.313-19
19 cm/7 1/2"

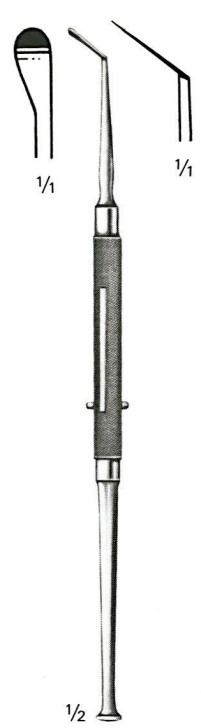

Freer
56.314-19
19 cm/7 1/2"

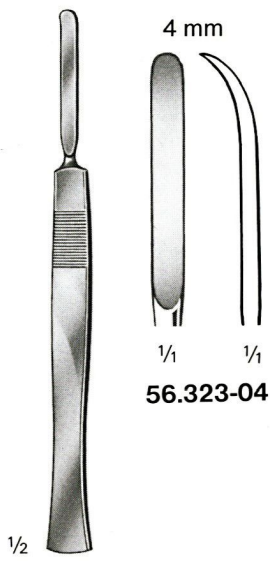

McKenty
56.323-04 – 56.323-05
15 cm/6"

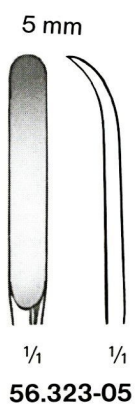

56.323-05

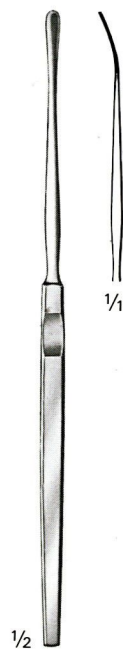

Halle
56.324-16
16 cm/6 1/2"

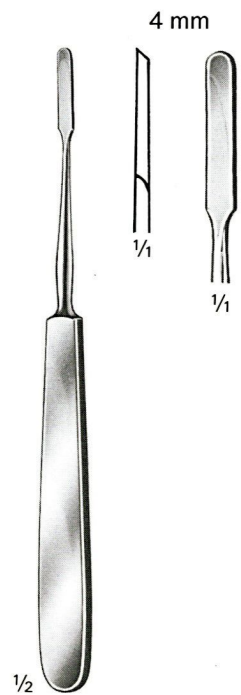

Fomon
56.325-17
17 cm/6 3/4"

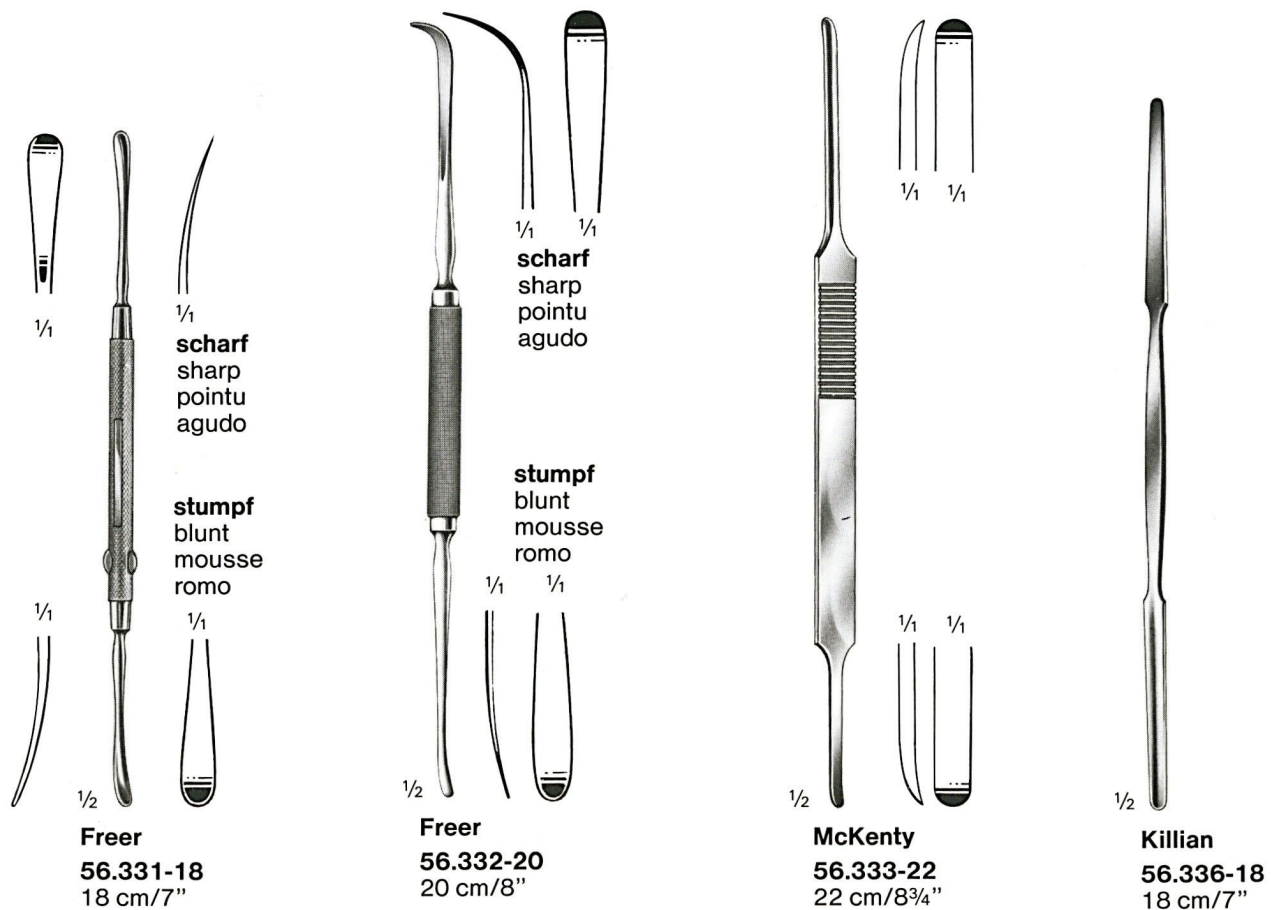
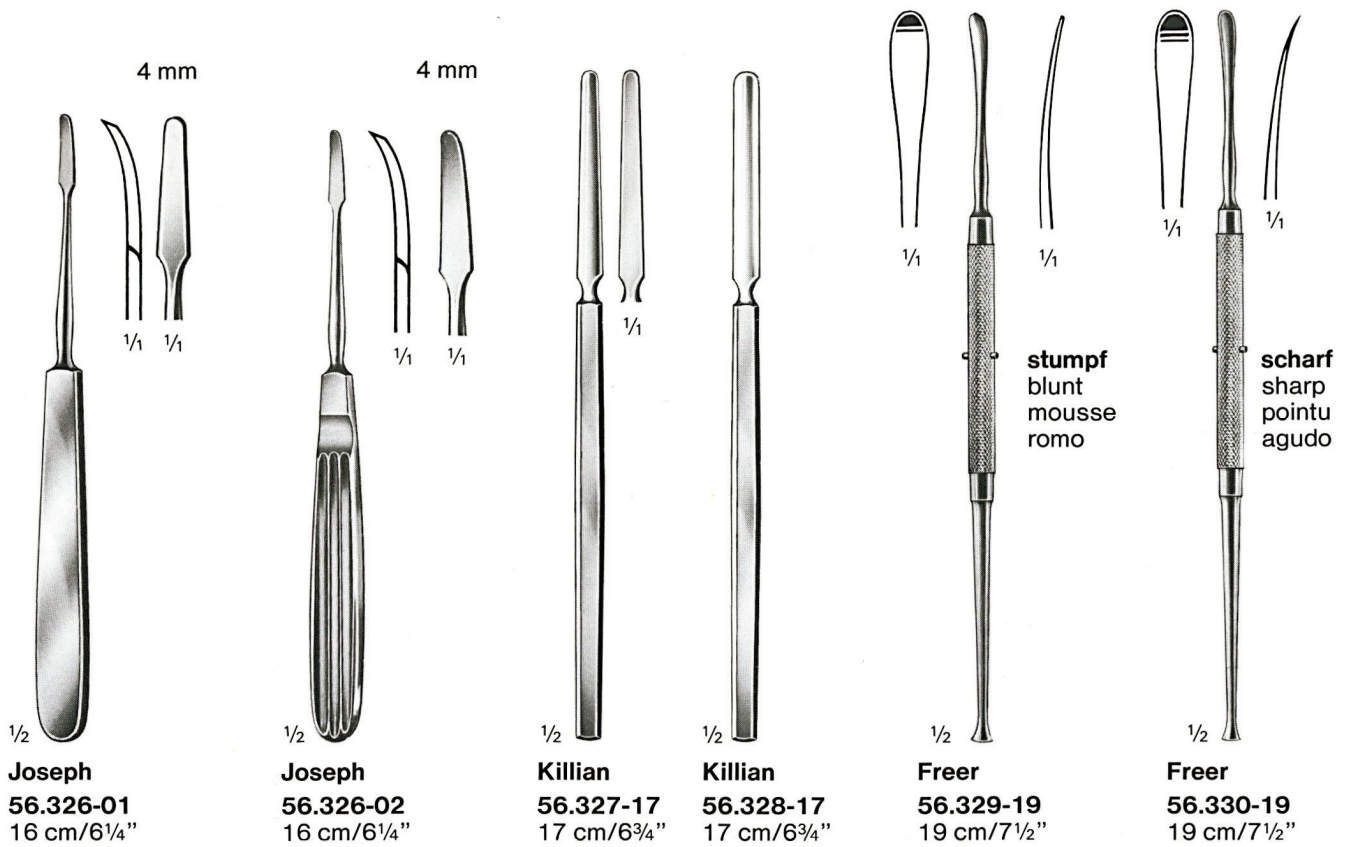



Cottle
56.337-23
23 cm/9"

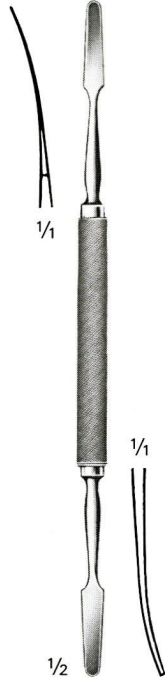

Killian
56.338-18
18 cm/7"

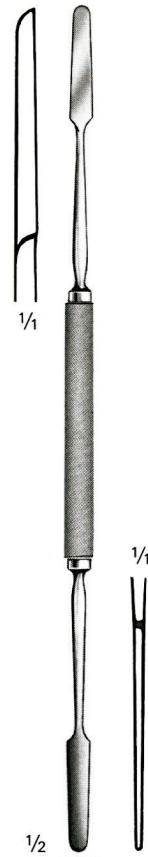

Killian
56.339-22
22 cm/8 3/4"

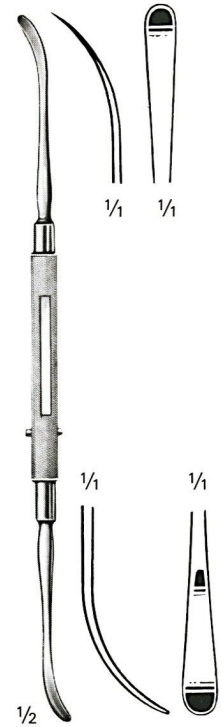

Roger
56.342-19
19 cm/7 1/2"

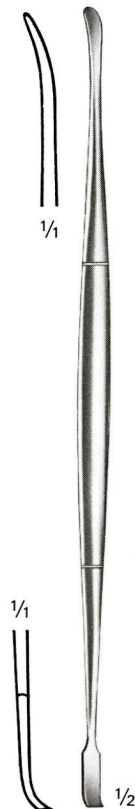

Howarth
56.346-21
21 cm/8 1/2"

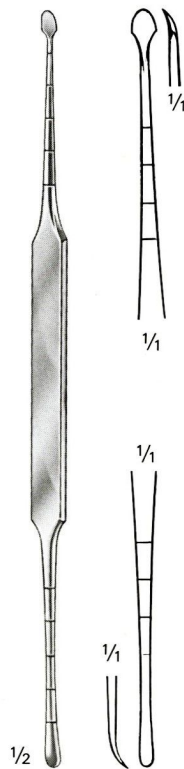

Masing
56.347-20
20 cm/8"

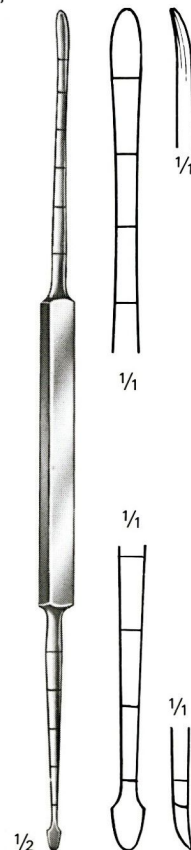

Cottle
56.348-21
21 cm/8 1/2"

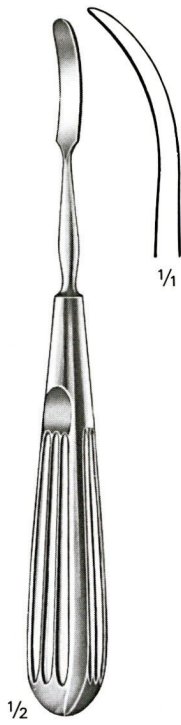

Joseph
56.349-16
 16 cm/6 1/4"

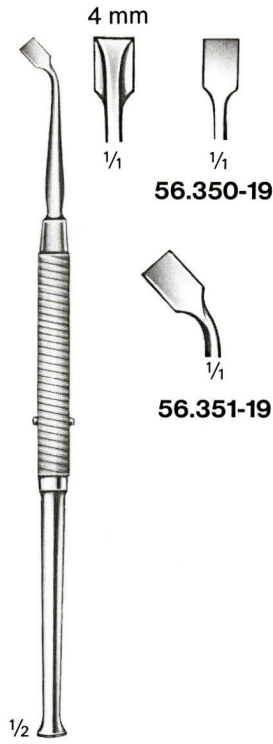

Freer
56.350-19 – 56.351-19
 19 cm/7 1/2"



Freer
56.352-16
 16 cm/6 1/4"

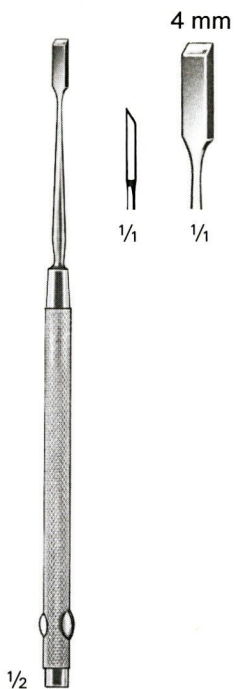

Freer
56.353-16
 16 cm/6 1/4"

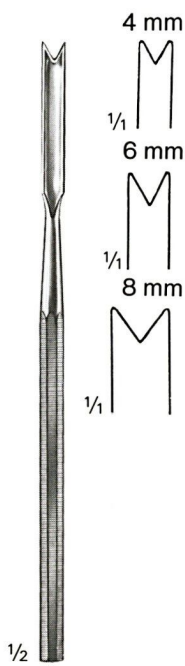

Ballenger
56.355-04 4 mm
56.355-06 6 mm
56.355-08 8 mm
 15 cm/6"



Killian
56.358-16
 16 cm/6 1/4"

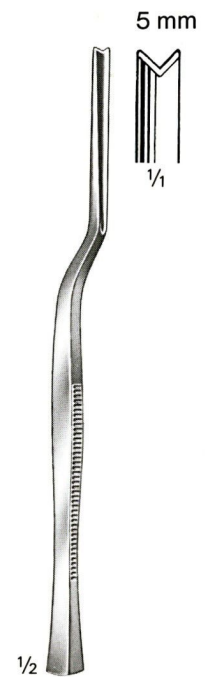

Killian
56.359-16
 16 cm/6 1/4"

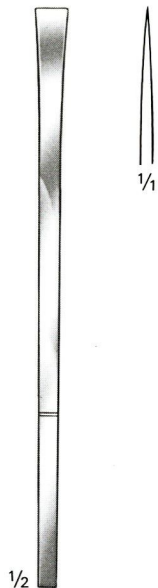

Cottle
56.362-07 7 mm
56.362-12 12 mm
15 cm/6"

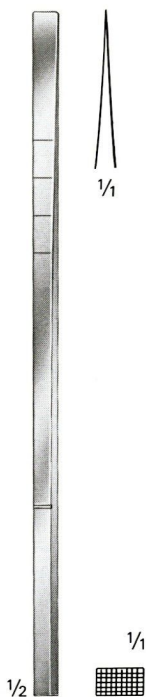

Cottle
56.363-04 4 mm
56.363-06 6 mm
56.363-07 7 mm
56.363-09 9 mm
56.363-12 12 mm
18 cm/7"

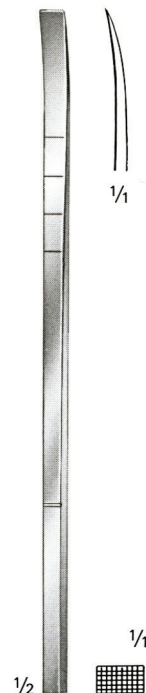

Cottle
56.364-06 6 mm
18 cm/7"

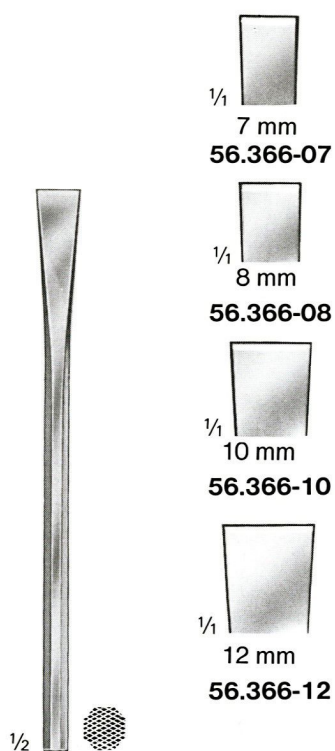

Sheehan
56.366-07 – 56.366-12
15 cm/6"

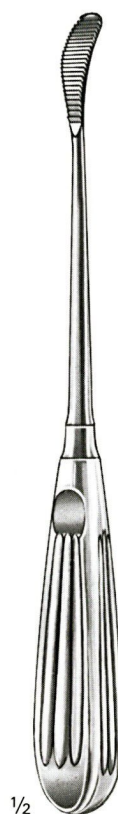

Aufricht
56.385-21 – 56.386-21
21 cm/8 1/4"

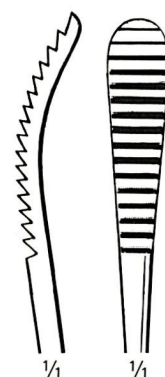

56.385-21

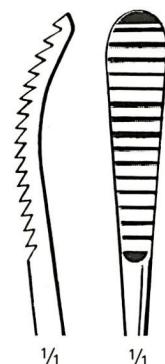

56.386-21

Nasenraspeln, Antrumraspeln, Schleimhauthäkchen

Nasal Rasps, Antrum Rasps, Mucous Hooks

Râpes nasales, Râpes pour le sinus maxillaire, Crochets pour la muqueuse

Escofinas nasales, Escofinas para seno maxilar, Gancho para las conas

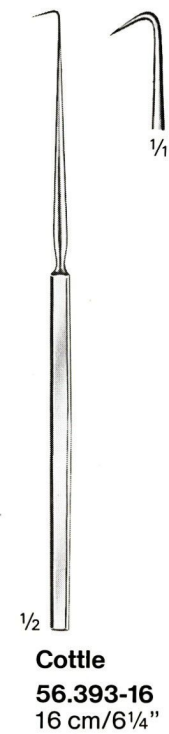
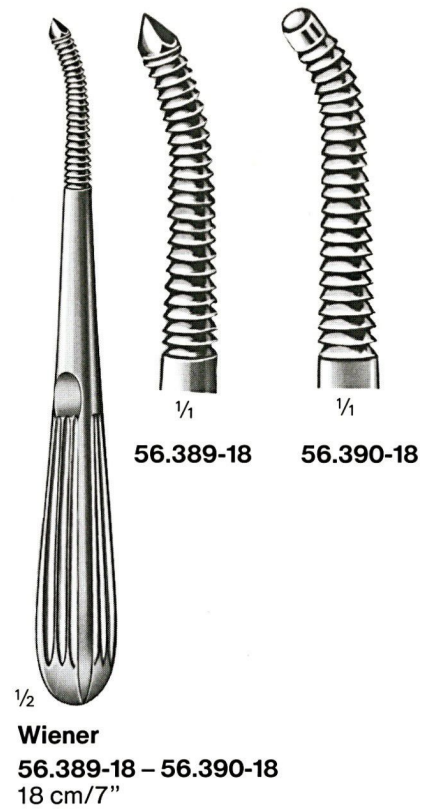
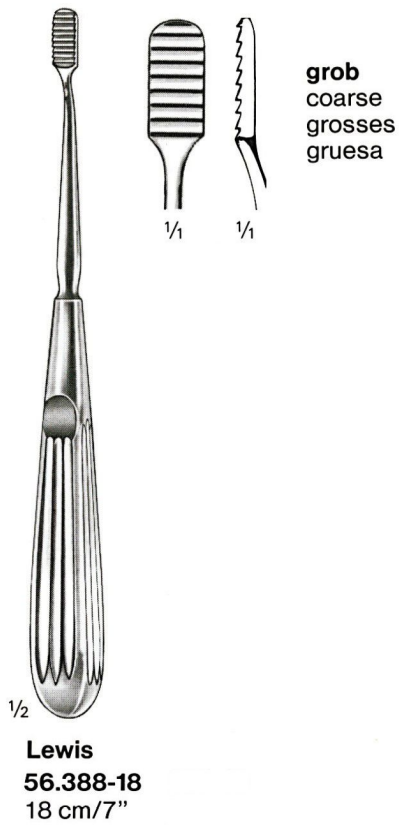

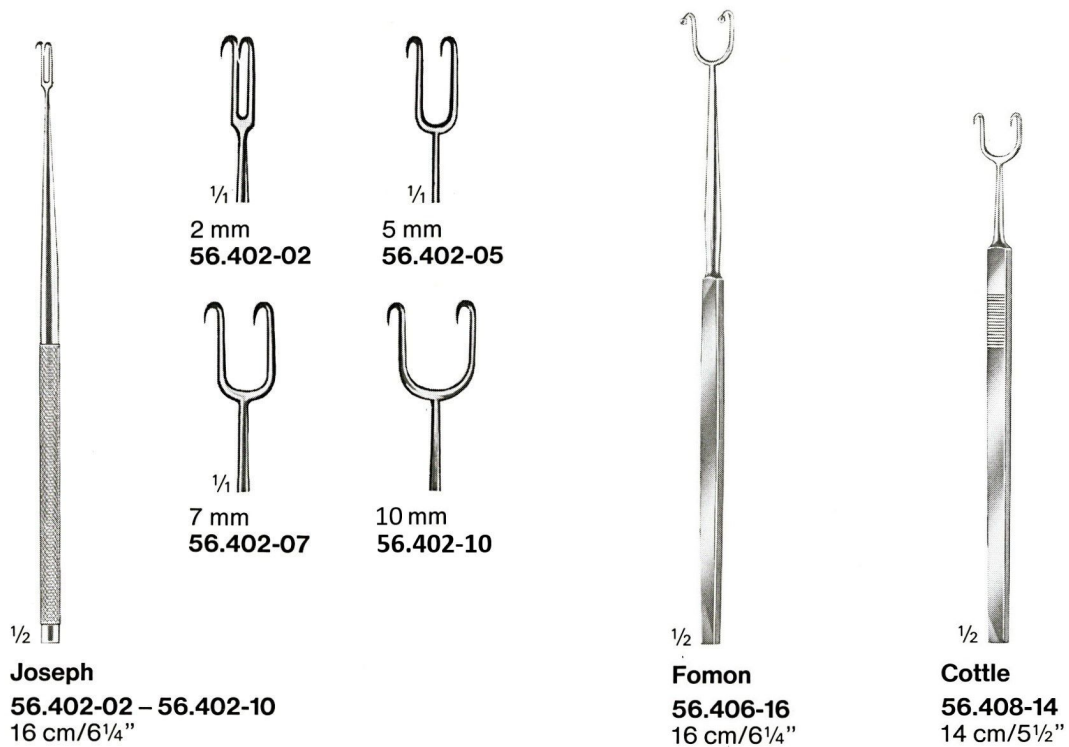
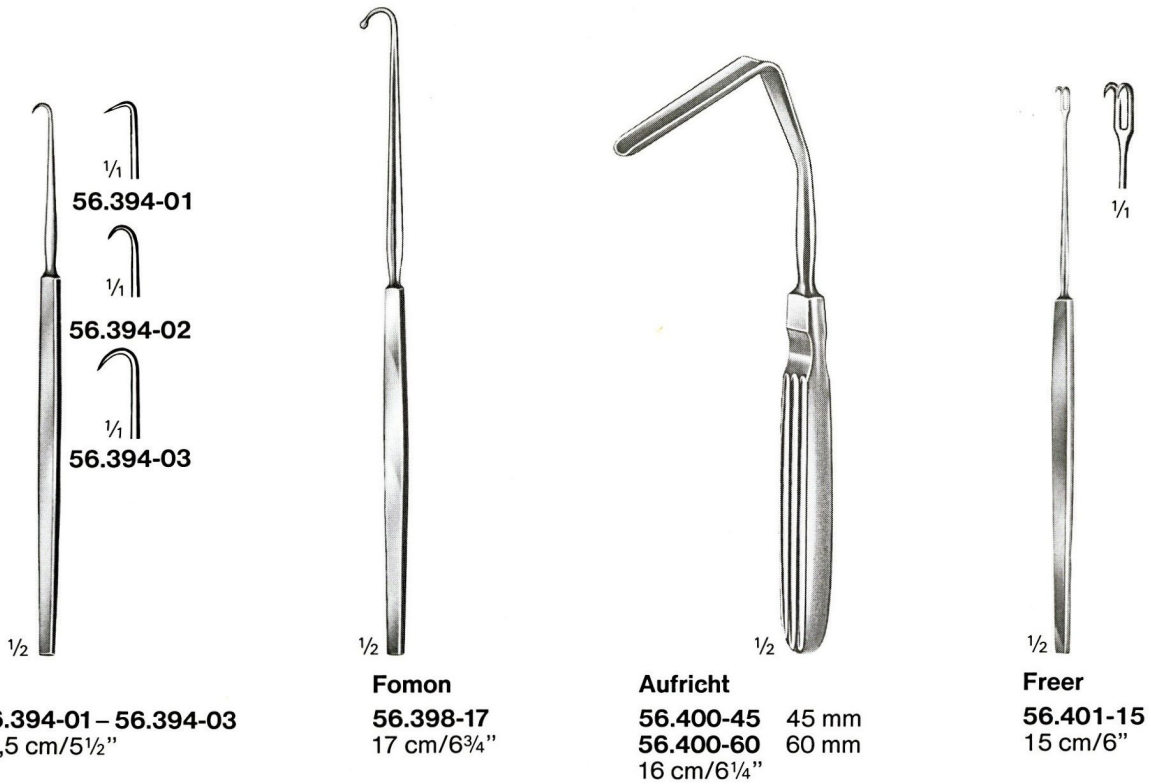

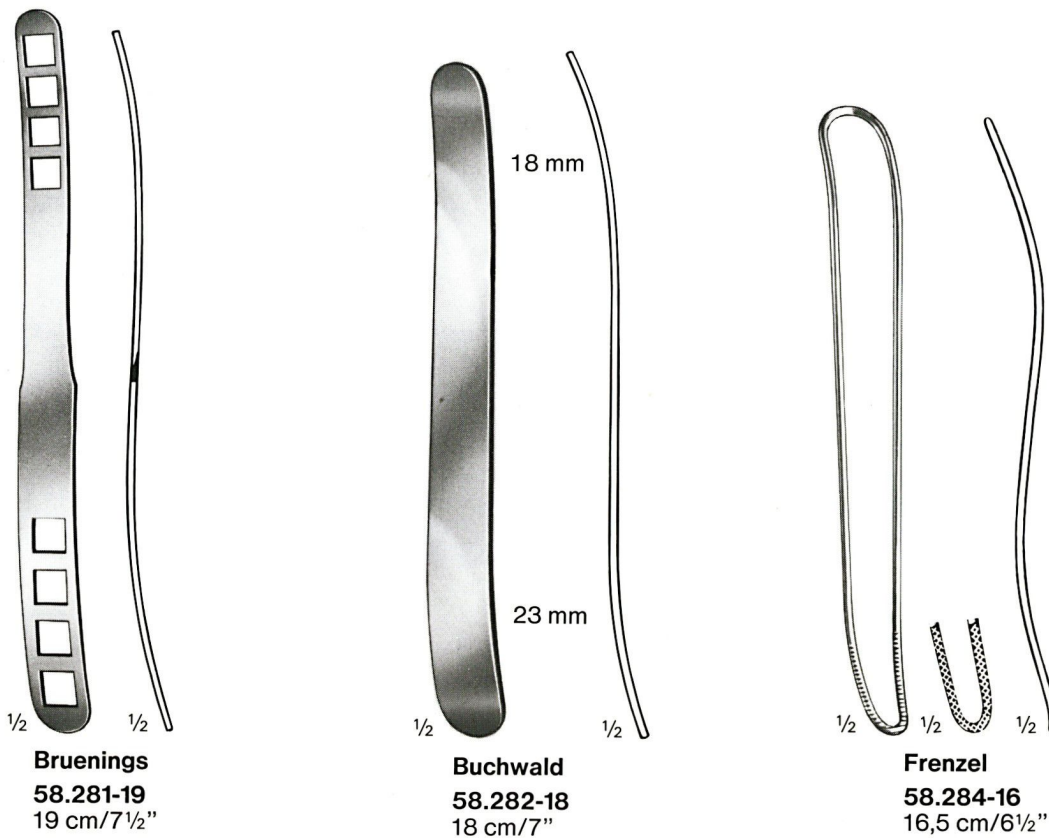
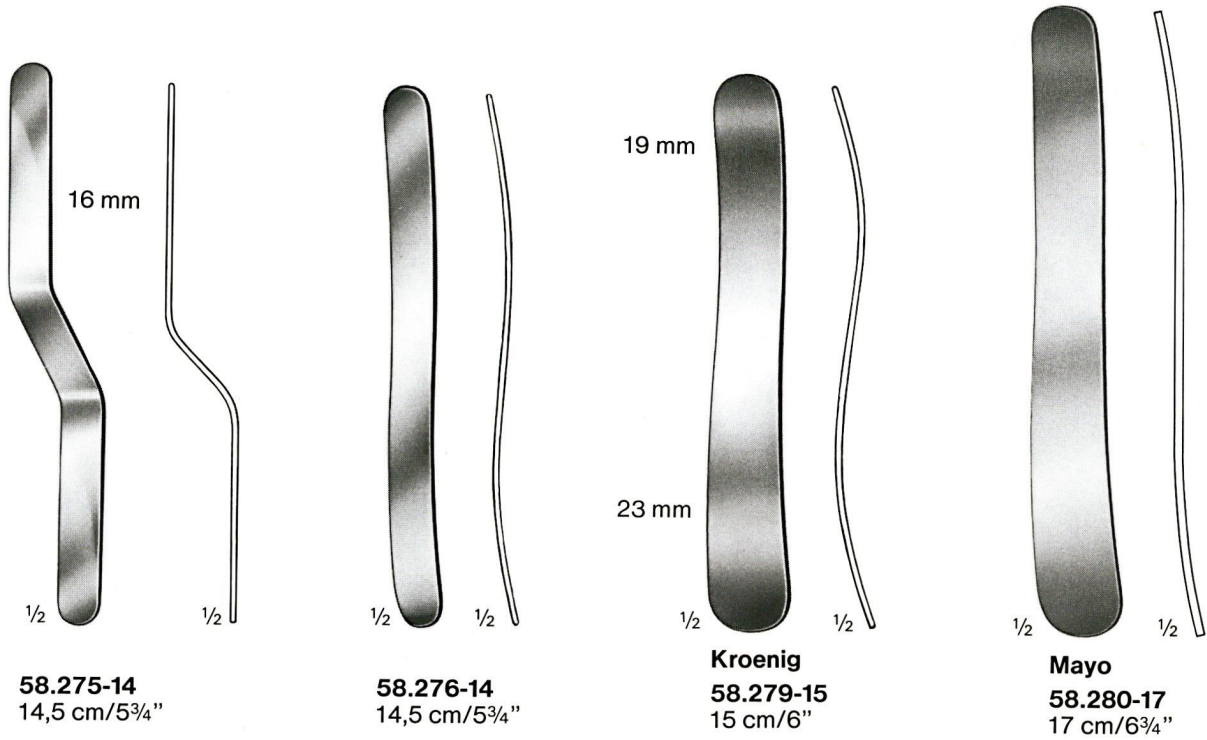



Hurd
60.250-22
22,5 cm/9"

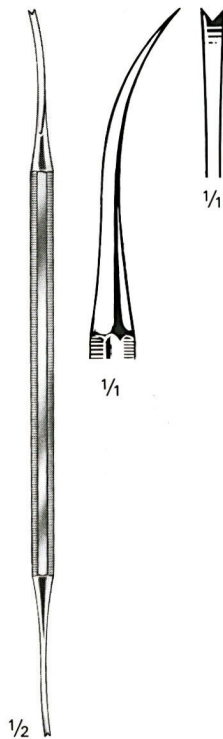

Luniatschek
60.258-19
19 cm/7 1/2"

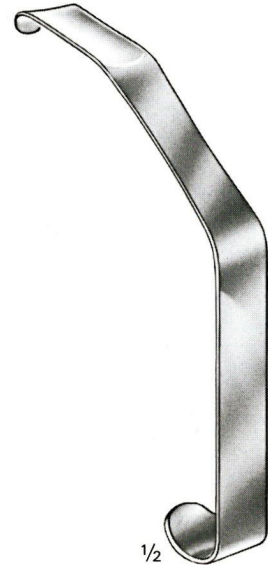

Love
60.260-18
60.260-20
60.260-22
15 cm/6"

Breite
width
largeur
ancho
18 mm
20 mm
22 mm

H	Seite		Seite
Haberer Bauchspatel	33	Knopfsonden	43
Häkchen	8, 9, 10	Knopfsonden mit Ohr	43
Halle Septum-Elevator	100	Kroenig Zungenspatel	107
scharfe Löffel	63	Kronecker Unterbindungsnadeln	47
Hartmann Ohrhäkchen	96	Kocher Blasenspatel.	84
Hauthäkchen	1	Wundhaken	15, 17, 19, 23
Hess Nervwurzelhaken	81	Kocher-Langenbeck , Wundhaken	18
Hoer Dura-Separatoren	78	König Knochenheber	73
Nervhaken.	80	Raspator	64
Hohmann Knochenheber	74, 75	Kuhnt Hornhautschaber	91
Hohlmeißel mit Novotex-Griff	57	Küretten	96
Hohlsonden	44		
Hohlsonden, geknöpft	44	L	
Holsher Nervwurzelhaken	79	Lahey Häkchen	7
Horsley Dura-Separator	78	Lambotte Flachmeißel	55
House Trachealhäkchen	3	Lange-Hohmann Knochenheber.	75
Howarth Septum-Elevator	102	Langenbeck Elevatorien	67, 68
Hurd Tonsillendissektor	108	Raspatorien.	64
		Wundhaken.	16, 20
I		Legue Blasenspatel	84
Iterson Trachealhäkchen	3	Lempert Elevatorien	98
		Exkavatoren	98
		scharfe Löffel	63, 98
J		Lewis Drahtschlingen	92
Jackson Trachealhäkchen	3, 4	Nasenraspeln	105
Jaeger Schielhaken	92	Lexer Flachmeißel	55
Jameson Schielhaken	92	Hohlmeißel	55
Jansen scharfer Löffel	64, 96	Little Wundhaken	16
Raspator	65	Love Haken.	108
Jochbogenahle	41	Nervwurzelhaken.	78
Jochbogenhaken	41	Lucae Knopfhäkchen	6, 96
Joseph Periosteotome	103	Luer Trachealhäkchen	3
Raspatorien	65	Lukens Wundhaken	4
Septum-Elevatorien	101, 103	Luniatscheck Tonsillen-Tamponstopfer	108
Schleimhauthäkchen	6, 7, 105, 106		
		M	
K		Martin Nervwurzelhaken	79
Katsch Komedonenquetscher.	82	Wundhaken und Scheidenhalter	35
Kieferahlen	41	Masing Septum-Elevator	102
Killian Septum-Elevatorien	101, 102	Mathieu Wundhaken	12
Septum-Hohlmeißel	103	Mayo Zungenspatel	107
Killian-Claus Septum-Hohlmeißel	103	McDonald Dissektor	69
Kinnhalter	38	McKenty Septum-Elevatorien	100, 101
Kilner Hauthäkchen	4	Meyerding Wundhaken	12
Kleinert-Kutz , Hauthäkchen	2	Mevhoefer Chalazionslöffel.	93
Knapp Häkchen	6, 91	Meyer Fremdkörper-Hohlmeißel.	91
Knapp-Rollet Häkchen.	92	Middeldorpf Wundhaken	28
Knochenheber.	73, 74, 75	Mikulicz Wund- und Bauchdeckenhaken	27
		Miller Häkchen	2

V

Seite

Vidal Lupusschaber	82
Volkmann scharfe Löffel	61
Wundhaken	15

W

Wagener Knopfhäkchen	6, 97
Walton Fremdkörper-Hohlmeißel	91
Wangenhaken.	35
Weber Drahtschlingen	92
Wiener Antrumraspeln	105
Irishäkchen	91
Williger Elevatorien	68
Raspatorien	65
scharfe Löffel	62
Wundhaken.	14, 15
Wundhaken für die Mund- und Kieferchirurgie.	36, 37

Z

Zaufal Fremdkörperheber.	96
Zenker Wundhaken	19
Zungenspatel	107

A	page	D	page
Adson , dura hook	80, 81	Dandy , neve Hooks	80
raspator	67	Davis , dura-dissector	77
Alderdyce , dissector.	69	Day , hooks	97
Arlt , lens scoops	92	Desmarres , lid retractors	5, 10, 90
Aufricht , glabellum rasps	104	Deschamps , ligature needles	47 - 52
nasal retractor	106	Dockhorn , cheek hook.	35
Awls for mouth-, jaw- and face surgery.	41	Doyen , probes	44
Axenfeld , hooks.	140	retractors	22
		vaginal speculas	85, 86
		Dura hooks	81
B		E	
Baby-Roux , retractor.	29	Elevators	69
Ballenger , septum-gouges	103	Emmet , fistula hooks.	5, 88
Bergmann , hook.	7	Epstein , bone curettes	59
Billeau , loops	96		
Blair , hooks.	1	F	
Bone curettes	63, 64, 96	Fistula probes and hooks.	98
Bone curettes with Novotex-Handle	62	Fomon , nasal rasps	106
Bone levers	114, 116	raspators	65
Bowdler-Henry's rake retractor	40	septum elevators	100
Breisky , vaginal speculas	87	Foreign Body Needles	91
Bruenings , tongue depressors	107	Frazier , dura separators	78
Bruns , bone curettes.	60, 61	hooks.	2, 81
Buchwald , tongue depressor	107	Freer , dissector	69
Buck , ear curettes	95	septum elevators	101
Buttoned probes.	43	septum gouges	103
		septum knives.	100
		mucous hooks	6, 106
		periosteotomes	103
		Frenzel , tongue depressors.	107
		Fritsch , retractors	21
C		G	
Carroll , hooks.	92	Gillies , osteotomes	40
Cloward , dura hook	81	skin hooks	4, 81
skin hook	1	Gil-Vernet , renal sinus retractors	30
Cobb , elevators	70	Graefe , iris hooks	5, 8, 91
gouges	71	strabismus hooks	92
Conway , lid retractor.	90	Graham , dura hook	80
Cooper , ligature needles	46	Gouges with Novotex-handle	57
Cope , trachea retractor	4	Guide Needle	53
Cottle , hooks	105	Guthrie , fixation hooks	5, 8, 91
nasal hooks	106		
septum and perionsteal elevators.	102		
Crile , nerve hooks	2, 78		
retractors	7		
Cushing , nerve hooks	2, 61		
raspatories.	64		
retractors	12		
skin hooks	1, 2, 81		
vein retractors	13, 14		
Cushing-Kocher , retractors.	9		

V

page

Vaginal retractors	85
Vidal , lupus scaber	82
Volkmann , bone curettes	61
retractors	15

W

Wagener , hooklets	6, 97
Walton , foreign body gouge.	91
Weber , lens scoops	92
Wiener , antrum rasps	105
iris hooks	91
Williger , bone curettes	62
elevators	68
raspatories	65

Z

Zaufal , foreign body lever.	96
Zenker , retractors	19